



Аппарат Губернатора, Правительства
Ханты-Мансийского автономного округа – Югры
Управление государственной регистрации
нормативных правовых актов
Внесен в государственный реестр нормативных
правовых актов исполнительных органов
Ханты-Мансийского автономного округа – Югры
За № 7188 от « 08 » 12 2023 г.

**ДЕПАРТАМЕНТ
ПРОСТРАНСТВЕННОГО РАЗВИТИЯ И АРХИТЕКТУРЫ
ХАНТЫ-МАНСИЙСКОГО АВТОНОМНОГО ОКРУГА – ЮГРЫ**

ПРИКАЗ

О внесении изменений в приказ Департамента строительства Ханты-Мансийского автономного округа – Югры от 21 сентября 2020 года № 23-нп «Об утверждении документации по планировке территории и внесении изменений в некоторые приказы Департамента строительства Ханты-Мансийского автономного округа – Югры»

**г. Ханты-Мансийск
от 1 декабря 2023 года**

№57 - нп

На основании статьи 45 Градостроительного кодекса Российской Федерации, Закона Ханты-Мансийского автономного округа – Югры от 18 апреля 2007 года № 39-оз «О градостроительной деятельности на территории Ханты-Мансийского автономного округа – Югры», постановления Губернатора Ханты-Мансийского автономного округа – Югры от 17 июня 2022 года № 70 «О Департаменте пространственного развития и архитектуры Ханты-Мансийского автономного округа – Югры» **п р и к а з ы в а ю:**

Внести в приказ Департамента строительства Ханты-Мансийского автономного округа – Югры от 21 сентября 2020 года № 23-нп «Об утверждении документации по планировке территории и внесении изменений в некоторые приказы Департамента строительства Ханты-Мансийского автономного округа – Югры» следующие изменения:

1. Приложение 17 изложить в следующей редакции:

«Приложение 17
к приказу Департамента строительства
Ханты-Мансийского
автономного округа – Югры
от 21 сентября 2020 года № 23-нп

**Проект межевания территории для размещения
объекта капитального строительства «Воздушная линия электропередач
протяженностью 68695 м, инв. № 00506112», расположенного на
территориях двух муниципальных образований Ханты-Мансийского
автономного округа – Югры. Графическая часть**

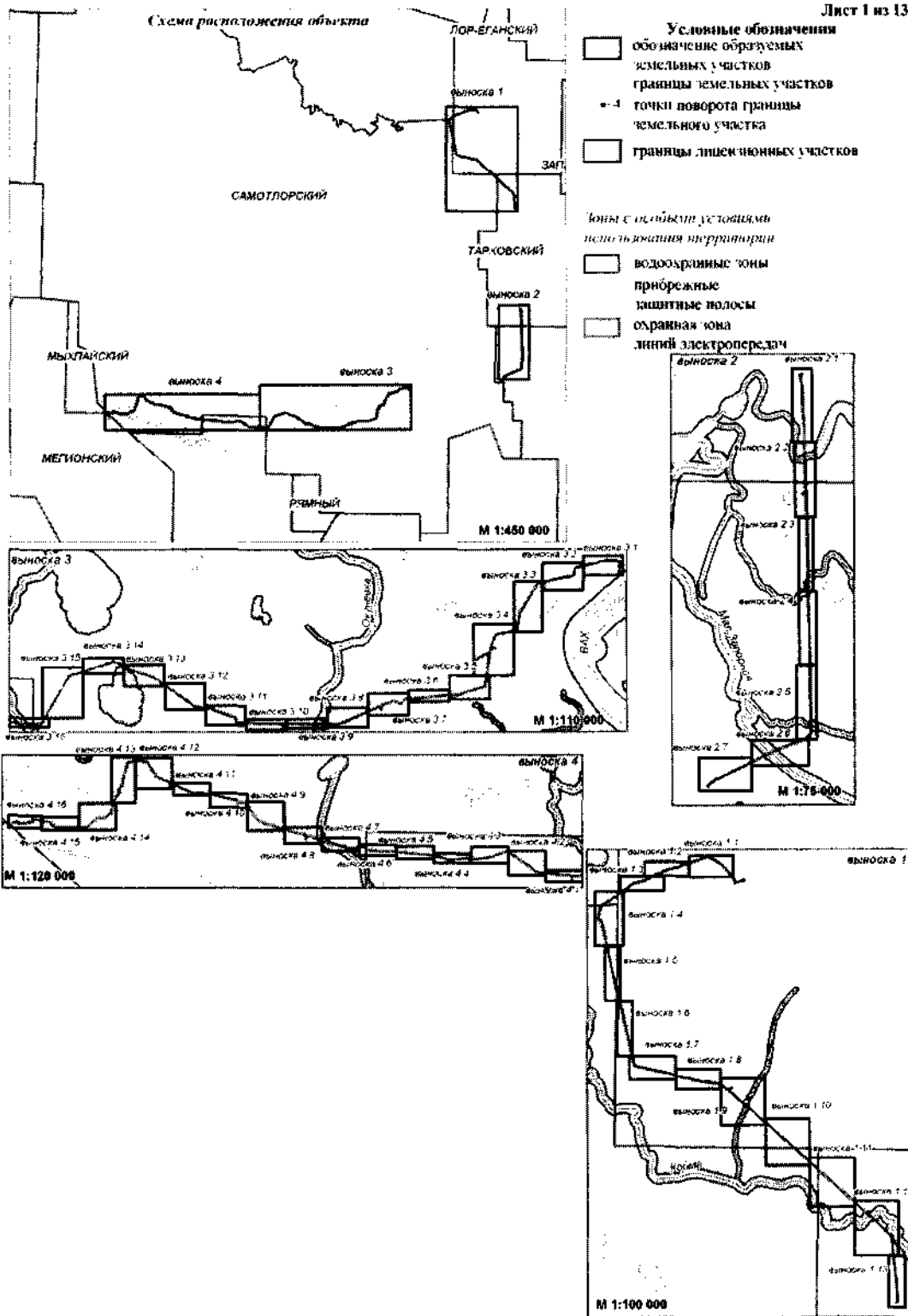

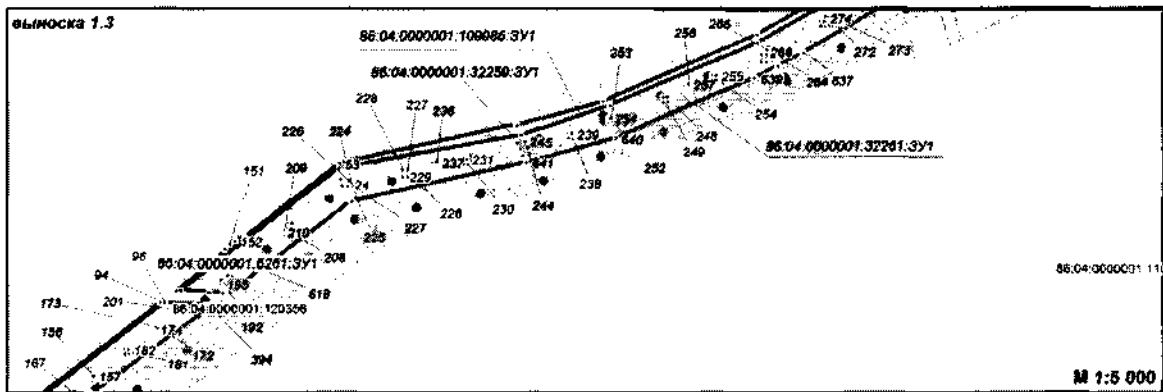
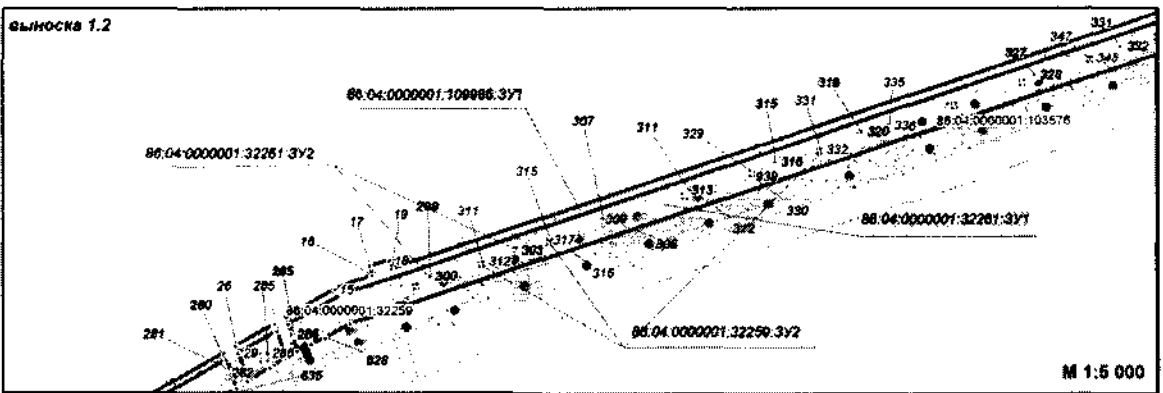
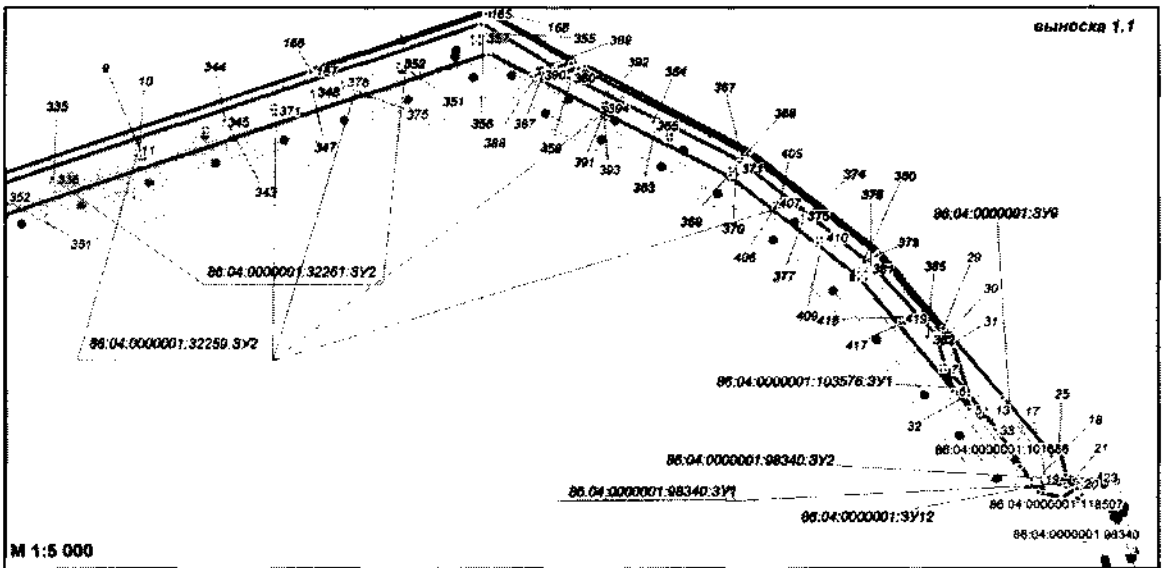

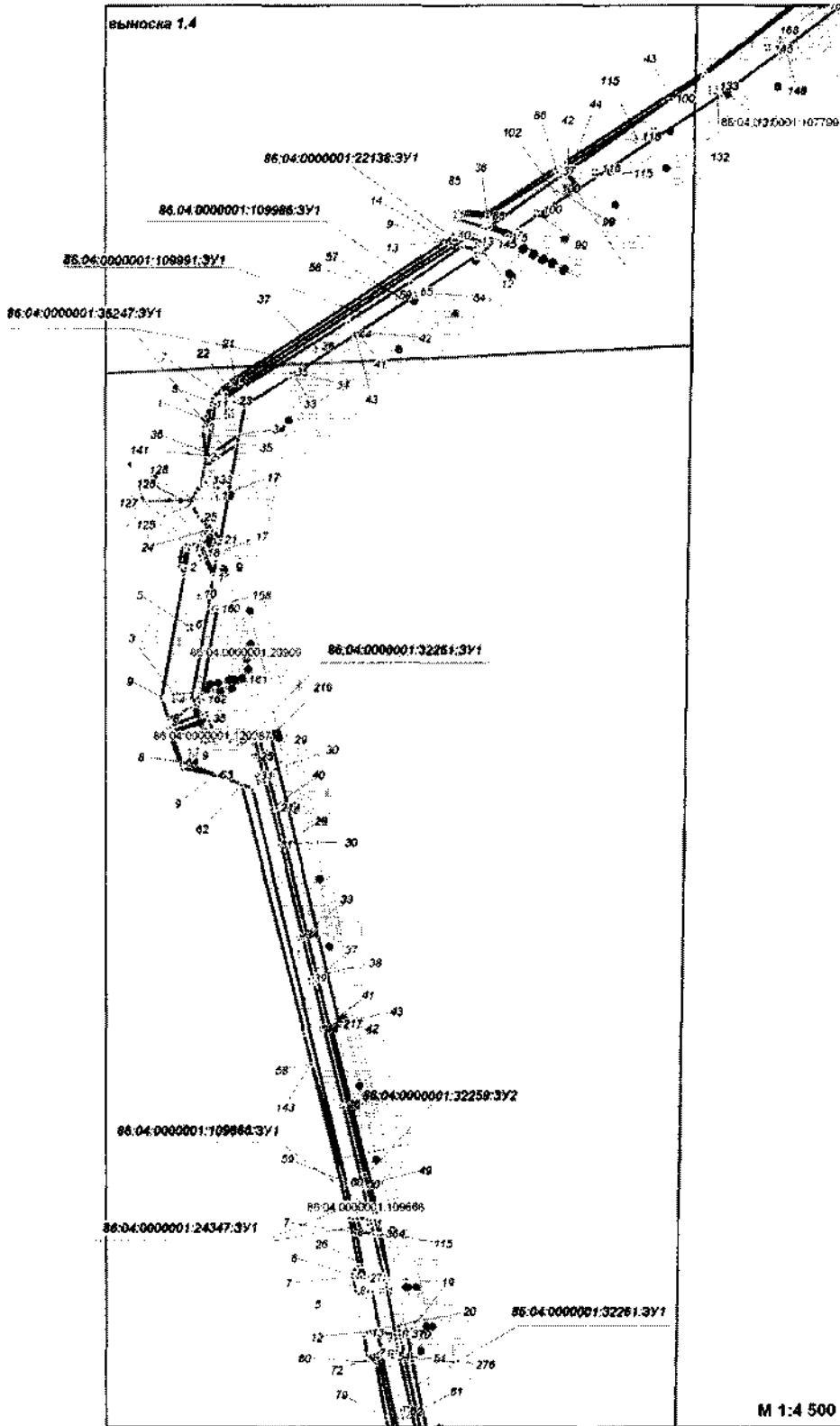

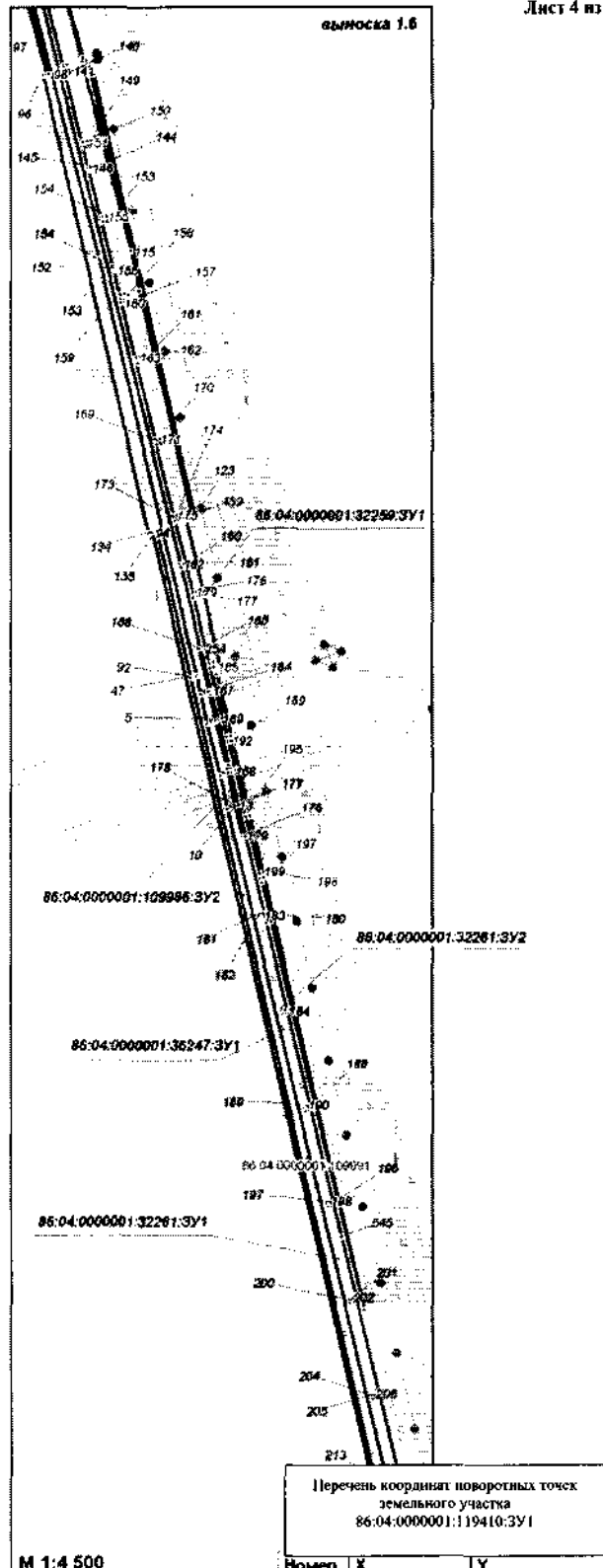
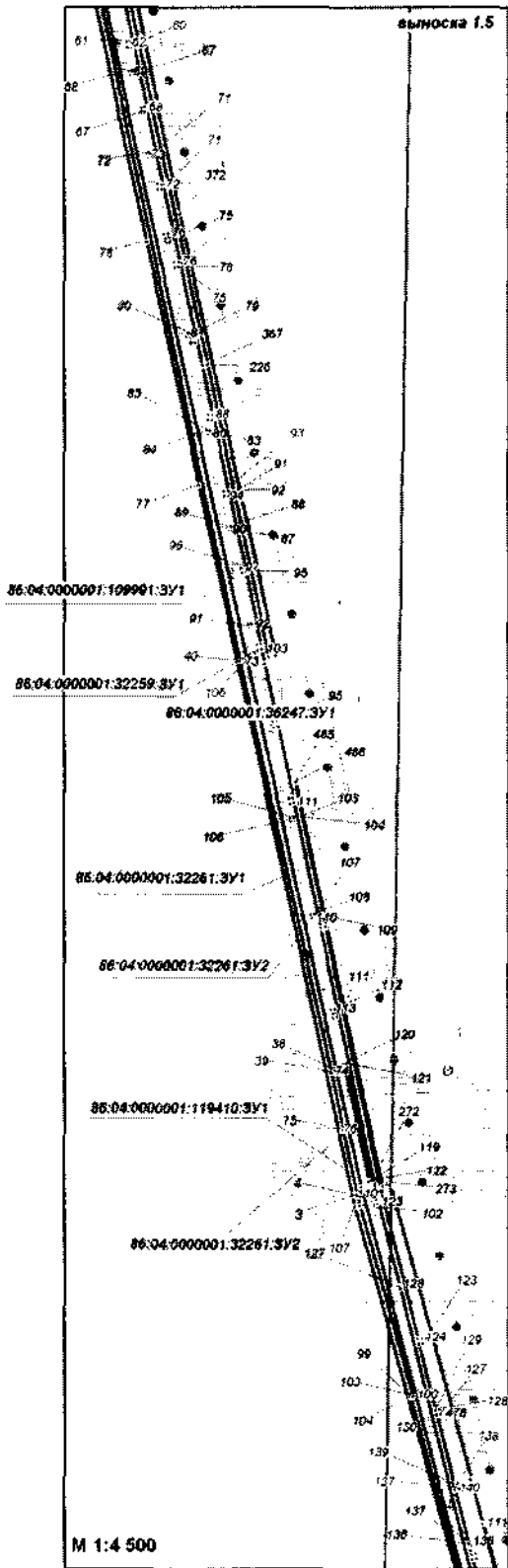

Перечень координат поворотных точек земельного участка 86:04:0000001:119410:3Y1

Номер	X	Y
1	982 652.88	4 443 588.59
2	982 653	4 443 592.59
3	982 603.28	4 443 603.07
4	982 603.17	4 443 599.4

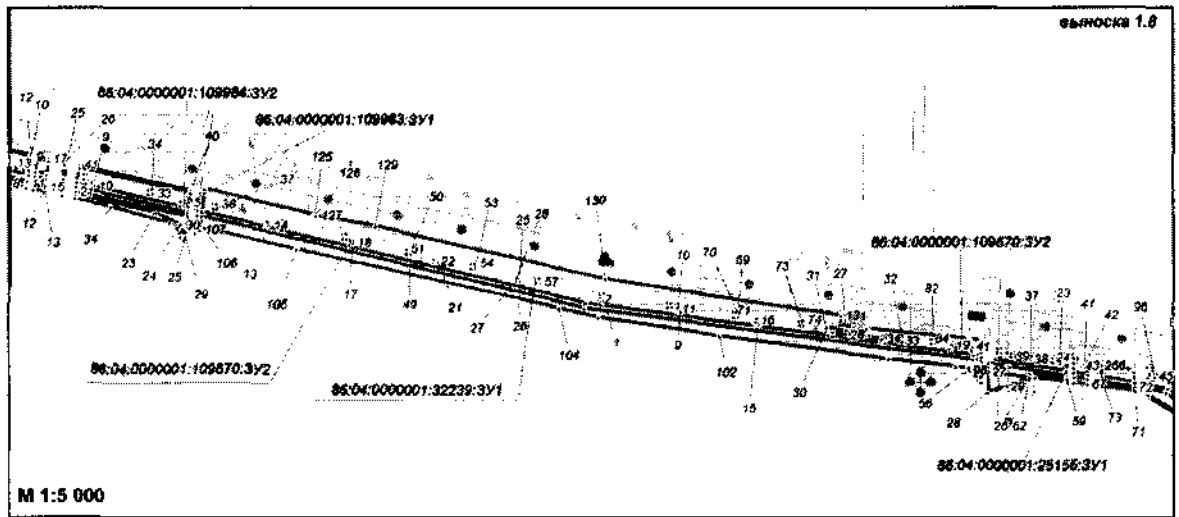
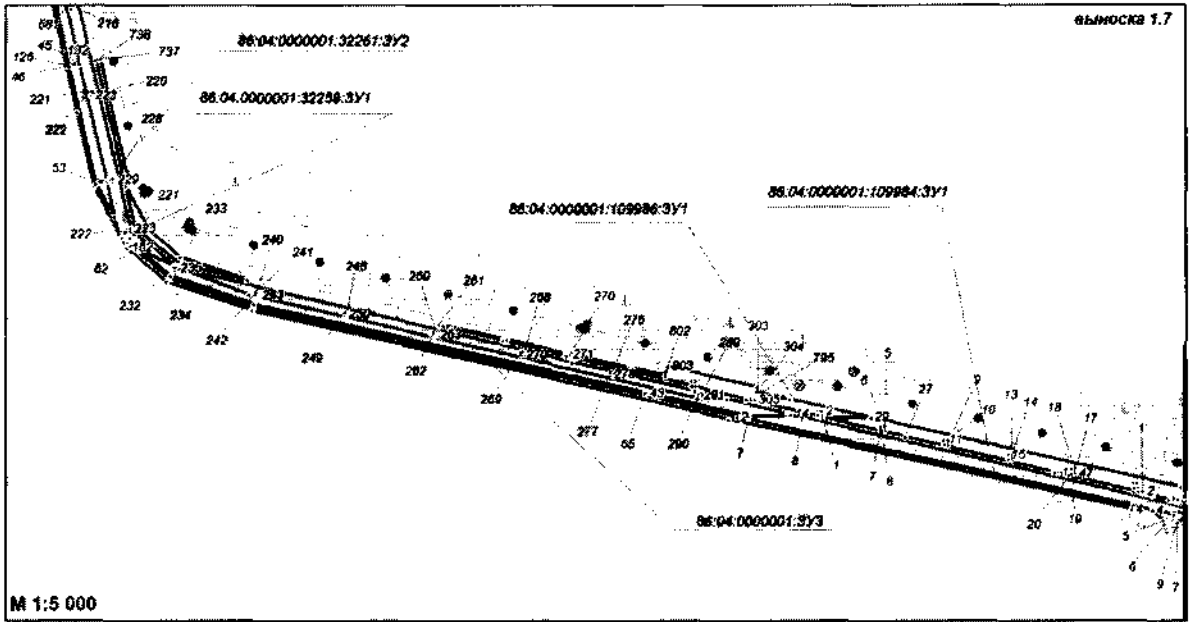

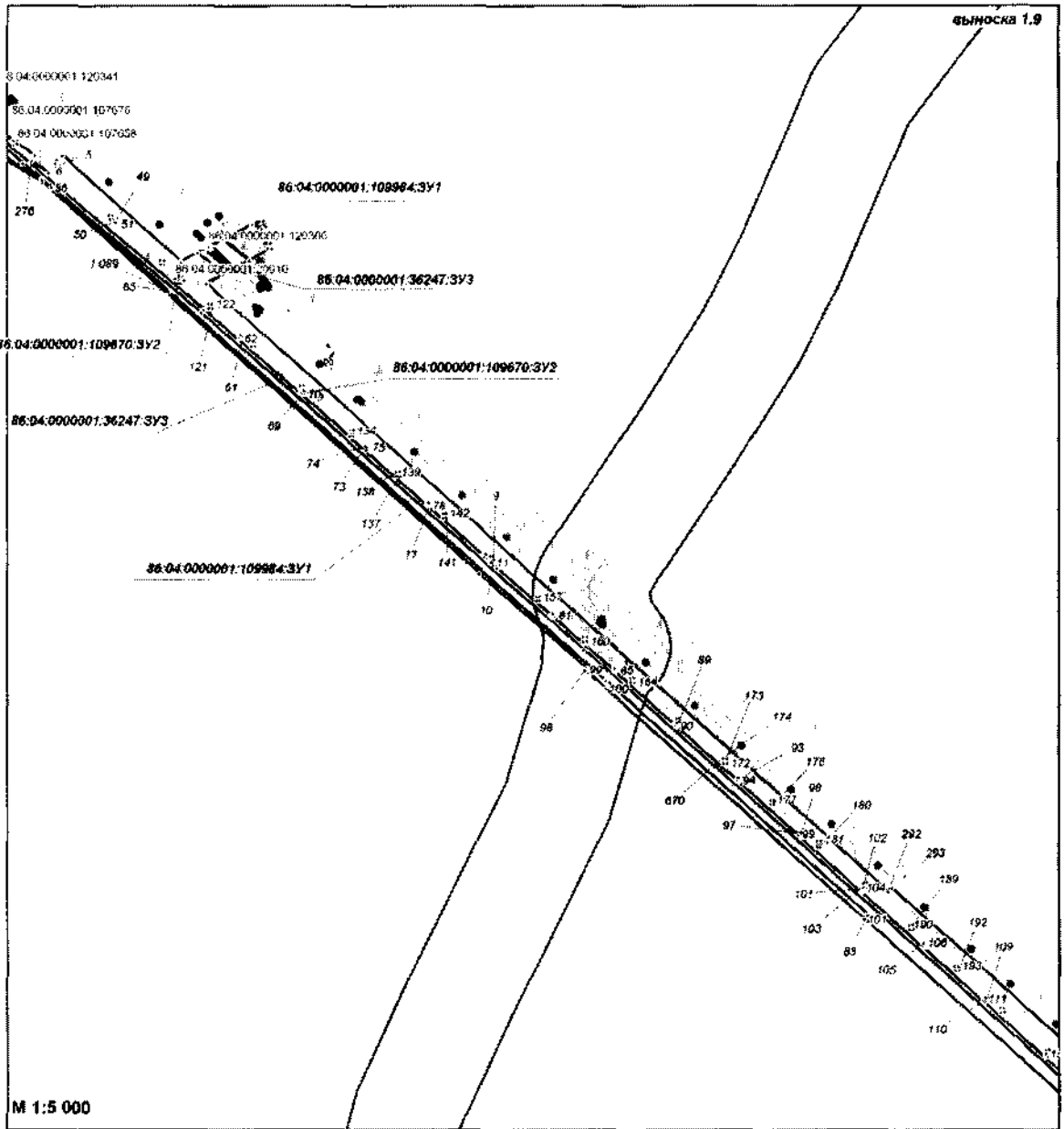

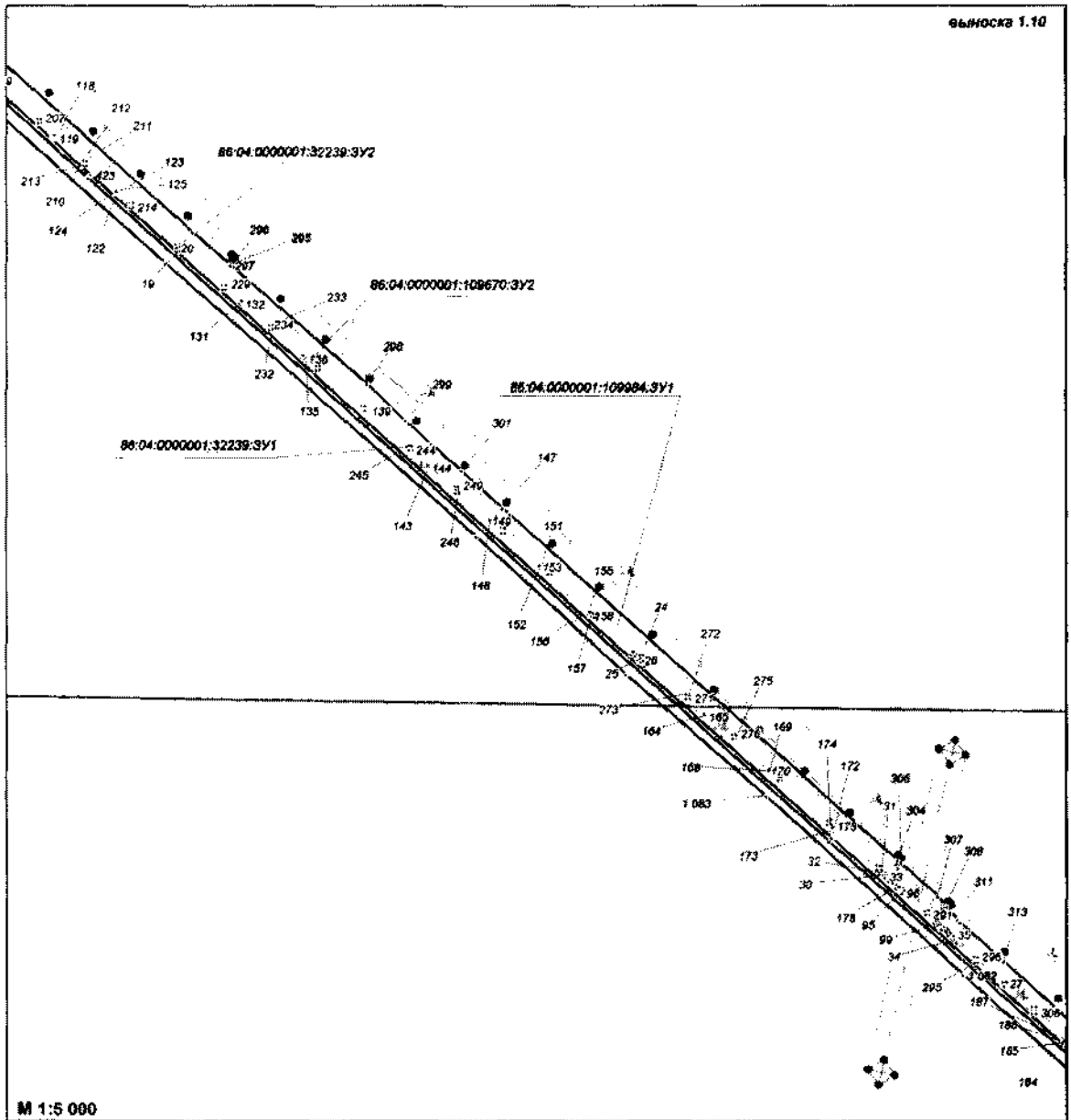

Выноска 1.11

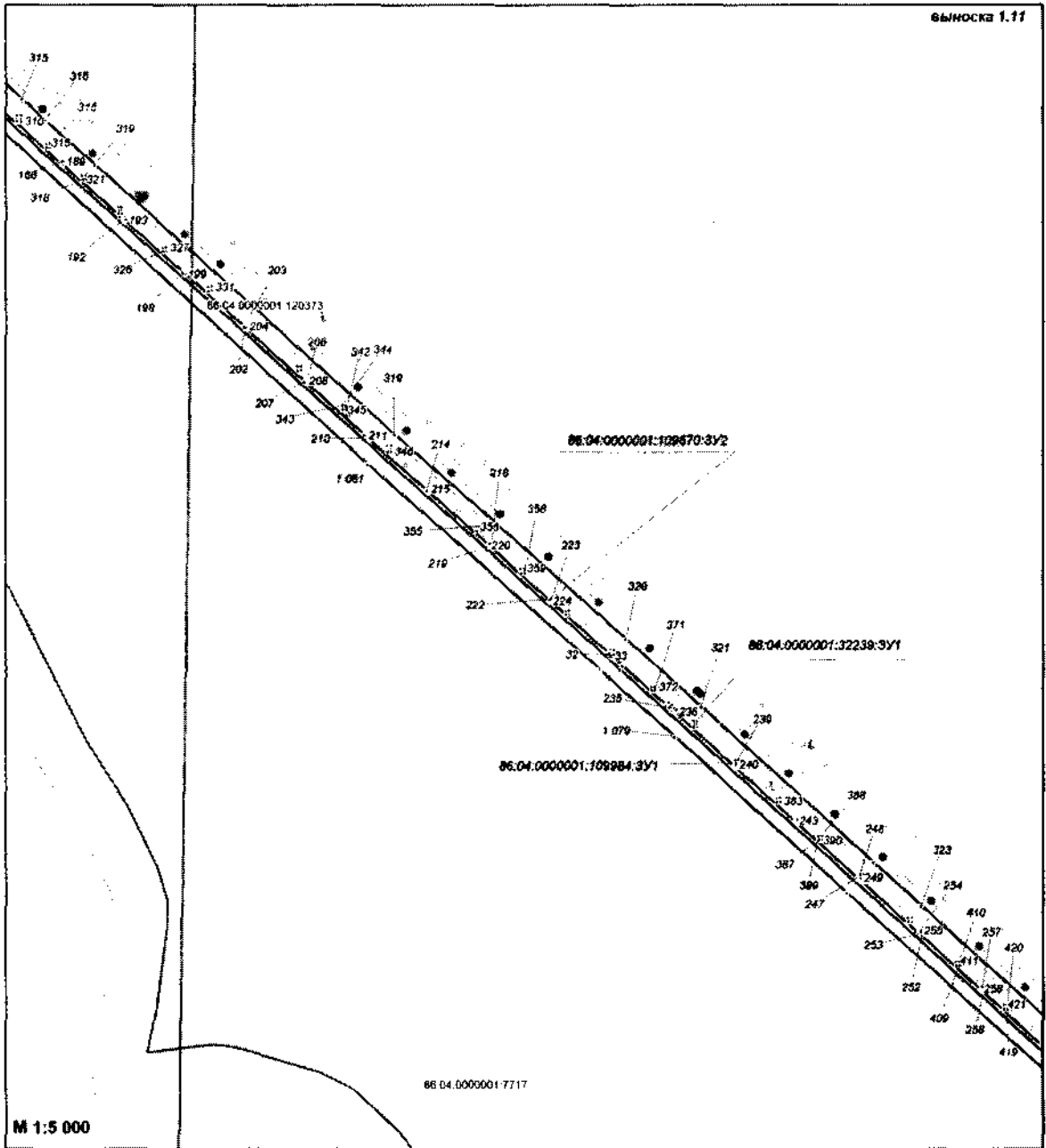

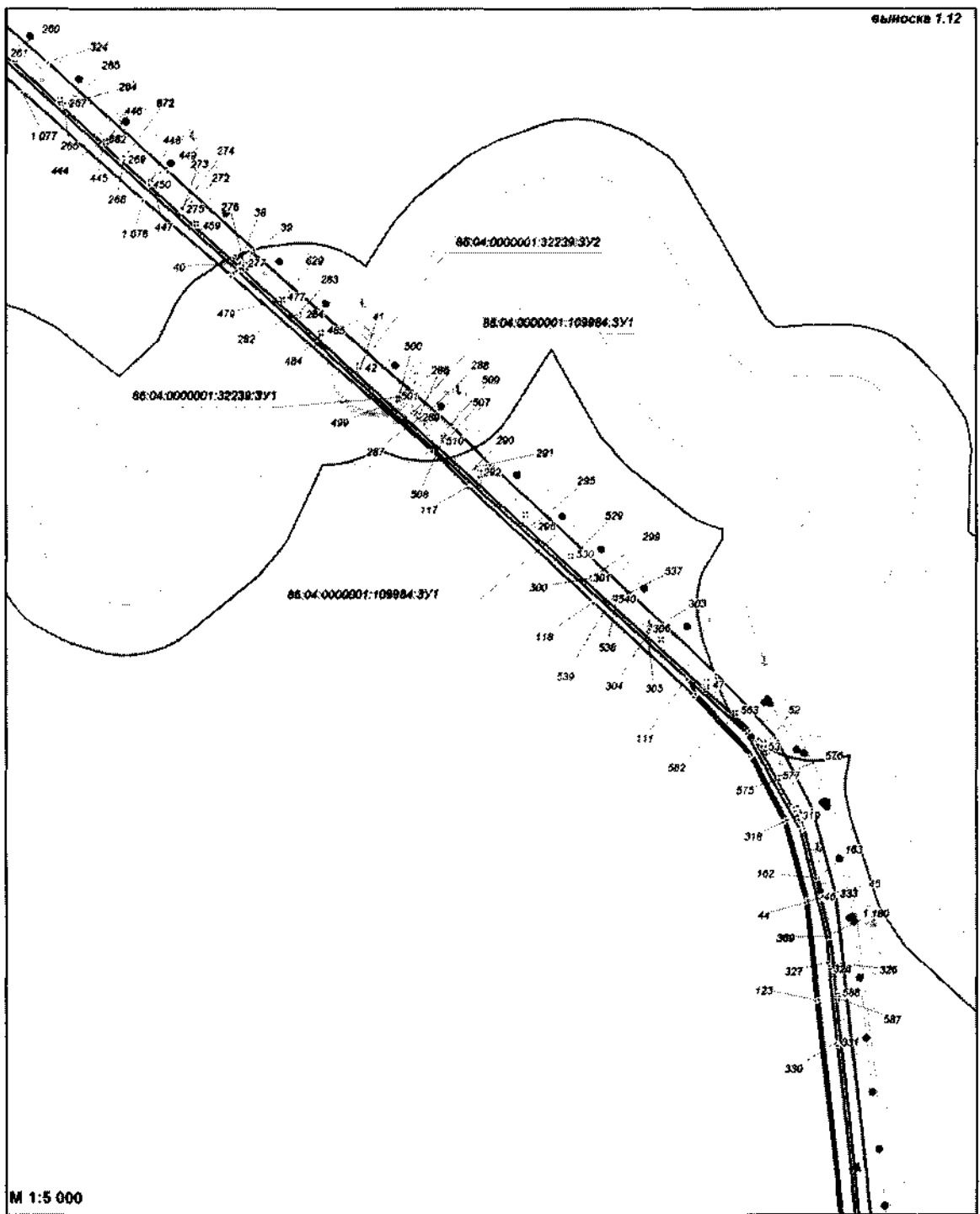

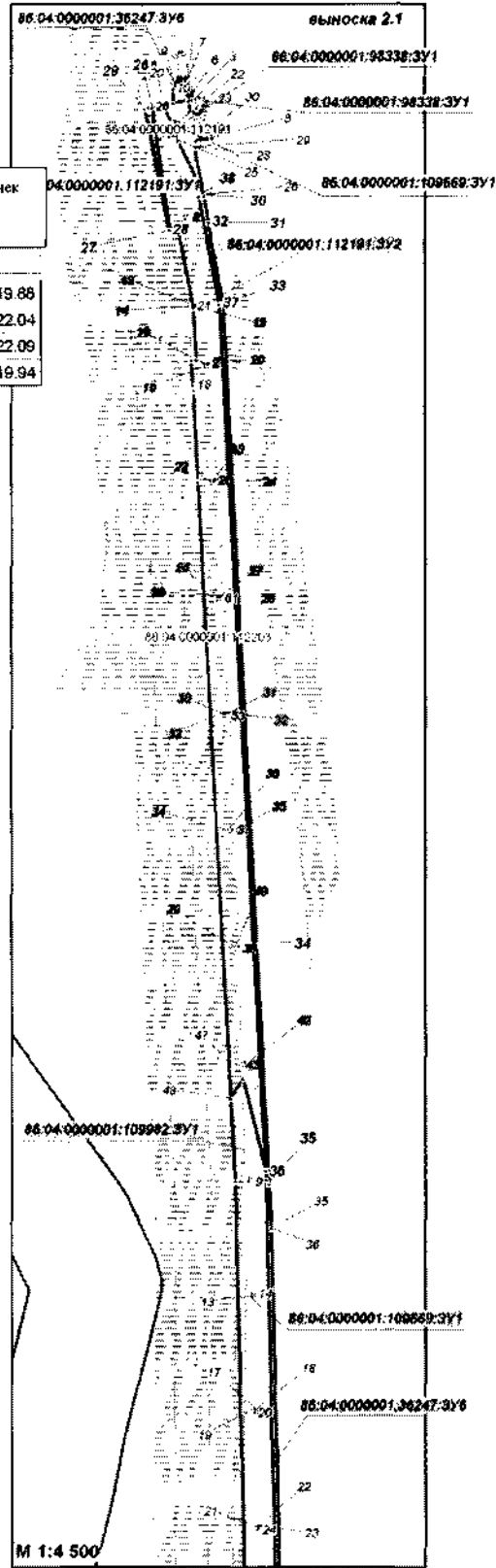
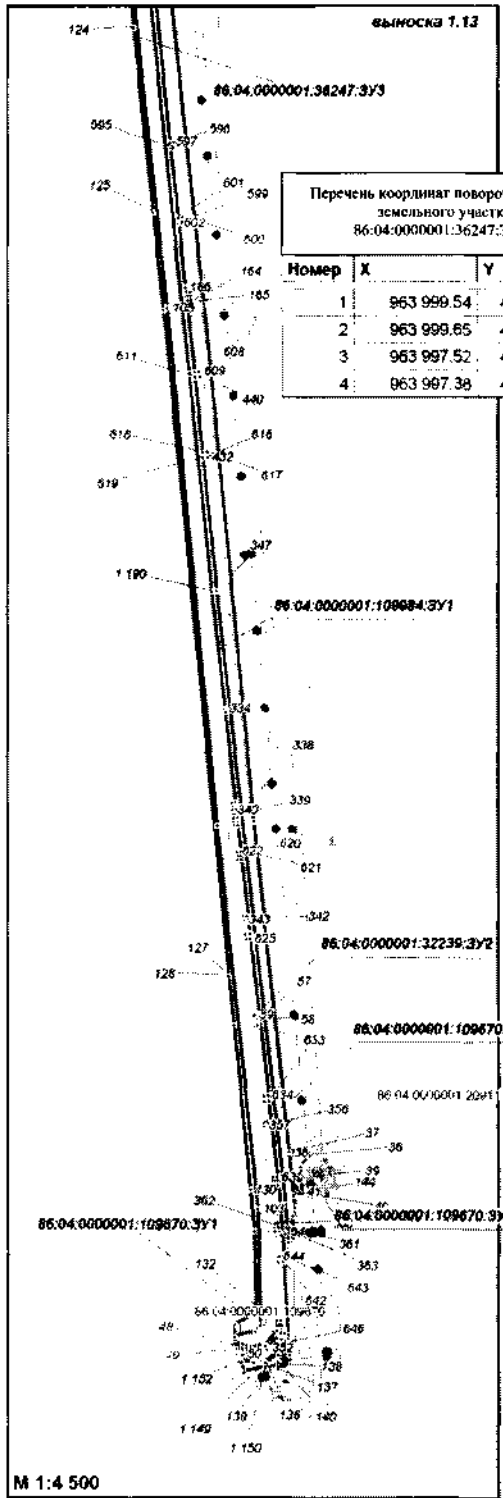

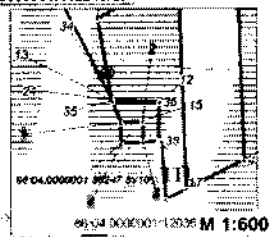
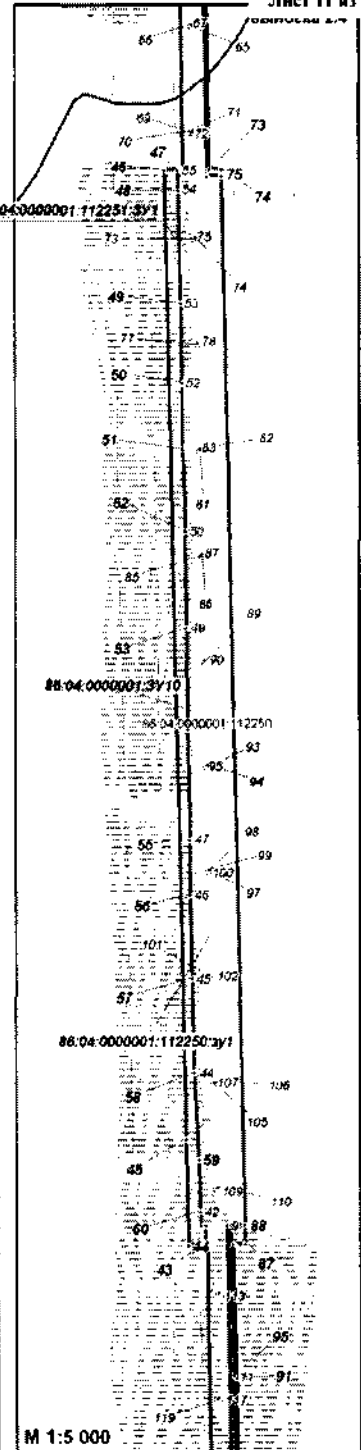
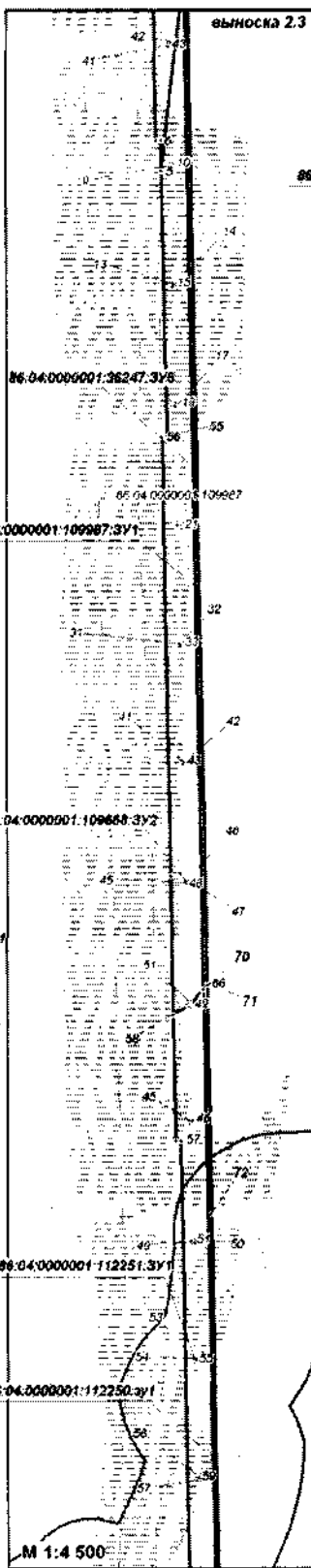
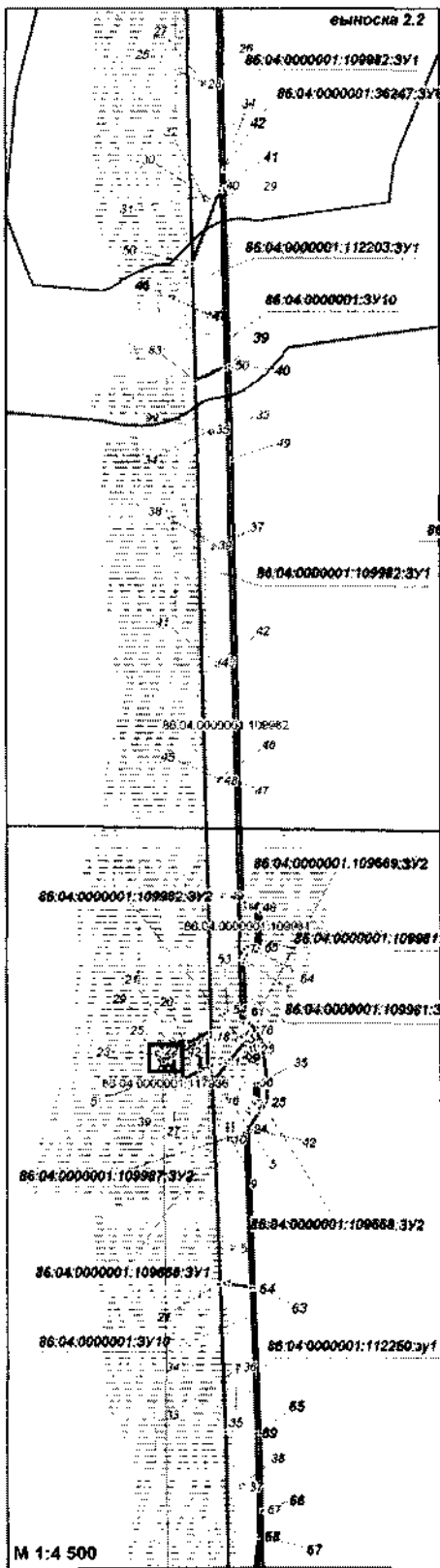

ВЫНОСКА

Схема расположения объекта

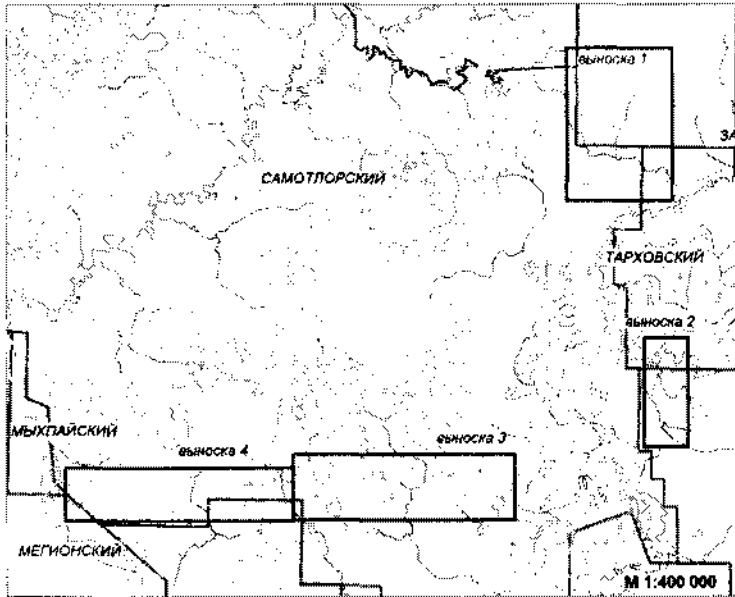

- Условные обозначения**
- обозначение образуемых земельных участков
 - границы земельных участков
 - точки поворота границы земельного участка
 - границы лицензионных участков

Зоны с особыми условиями использования территории

- водоохранные зоны
- прибрежные защитные полосы
- охранный зона линий электропередач

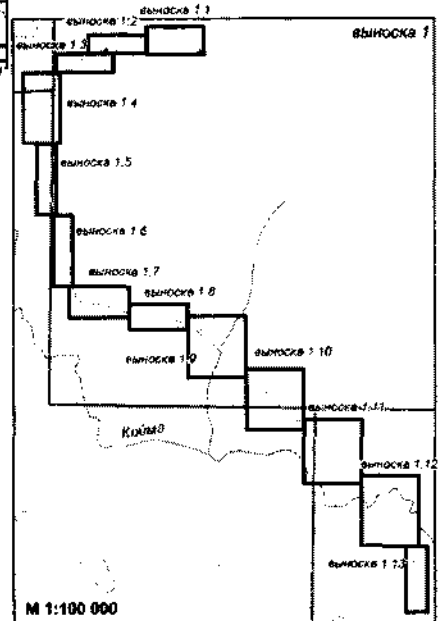
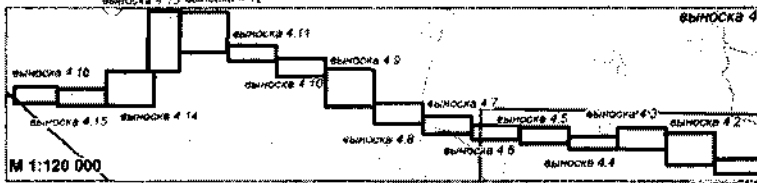
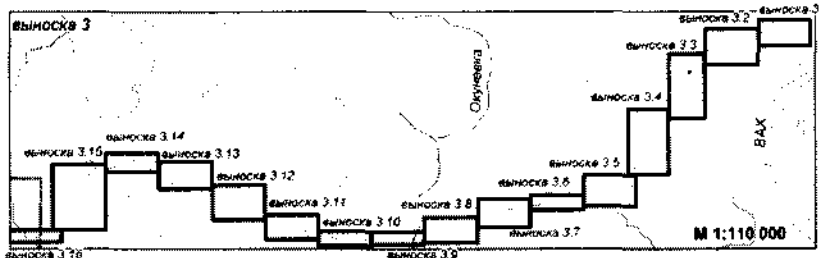
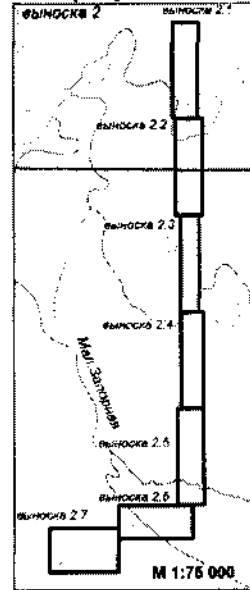

Перечень координат поворотных точек
земельного участка
86:04:000001:110002:3У2

Номер	X	Y
1	954 594.59	4 433 542.72
2	954 594.37	4 433 540.53
3	954 596.66	4 433 540.31
4	954 596.87	4 433 542.5
5	954 784.05	4 434 051.15
6	954 781.99	4 434 050.05
7	954 783.26	4 434 048.5
8	954 785.03	4 434 048.96
9	954 837.83	4 434 088.52
10	954 837.64	4 434 086.33
11	954 839.92	4 434 086.15
12	954 840.12	4 434 088.32
13	954 905.52	4 434 826.35
14	954 903.2	4 434 826.29
15	954 903.14	4 434 825.67
16	954 905.44	4 434 825.48
17	954 323.73	4 432 692.07
18	954 320.3	4 432 683.86
19	954 323.07	4 432 682.67
20	954 326.47	4 432 690.86
21	954 358.52	4 432 771.44
22	954 330.52	4 432 707.67
23	954 333.28	4 432 706.48
24	954 361.28	4 432 770.24

Перечень координат поворотных точек
земельного участка 86:04:000001:36247:3У9

Номер	X	Y
1	955 806.95	4 435 854.12
2	955 808.96	4 435 853.23
3	955 808.06	4 435 851.12
4	955 806.04	4 435 852
5	955 844.25	4 435 930.45
6	955 846.27	4 435 929.55
7	955 845.36	4 435 927.44
8	955 843.34	4 435 928.33
9	955 881.63	4 436 007.14
10	955 883.64	4 436 006.25
11	955 882.74	4 436 004.14
12	955 880.72	4 436 005.02
13	955 918.99	4 436 083.16
14	955 921	4 436 082.27
15	955 920.1	4 436 080.15
16	955 918.08	4 436 081.04

Перечень координат поворотных точек
земельного участка 86:04:000001:36247:3У8

Номер	X	Y
1	955 768.97	4 435 796.95
2	955 798.07	4 435 814.24
3	955 796.12	4 435 815.24
4	955 798.07	4 435 819.05
5	955 801.85	4 435 817.1
6	955 801.4	4 435 816.22
7	955 802.6	4 435 816.93
8	955 813.94	4 435 843
9	955 818.52	4 435 847.9
10	955 840.48	4 435 892.43
11	955 836.7	4 435 894.38
12	955 838.65	4 435 898.18
13	955 842.44	4 435 896.23
14	955 879.77	4 435 973.04
15	955 877.41	4 435 974.26
16	955 879.36	4 435 978.07
17	955 881.65	4 435 976.89
18	955 919.94	4 436 055.1
19	955 918.81	4 436 055.88
20	955 920.76	4 436 059.48
21	955 921.82	4 436 058.94
22	955 960.06	4 436 136.92
23	955 961.1	4 436 139.51
24	955 961.1	4 436 139.52
25	955 921.06	4 436 133.86
26	955 926.52	4 436 131.2
27	955 926.48	4 436 131.05
28	955 926.48	4 436 131.04
29	955 793.41	4 435 859.16
30	955 765.34	4 435 796.78
31	955 920.1	4 436 080.15
32	955 921	4 436 082.27
33	955 918.99	4 436 083.16
34	955 918.08	4 436 081.04
35	955 808.06	4 435 851.12
36	955 808.96	4 435 853.23
37	955 806.95	4 435 854.12
38	955 806.04	4 435 852
39	955 882.74	4 436 004.14
40	955 883.64	4 436 006.25
41	955 881.63	4 436 007.14
42	955 880.72	4 436 005.02
43	955 845.36	4 435 927.44
44	955 846.27	4 435 929.55
45	955 844.25	4 435 930.45
46	955 843.34	4 435 928.33

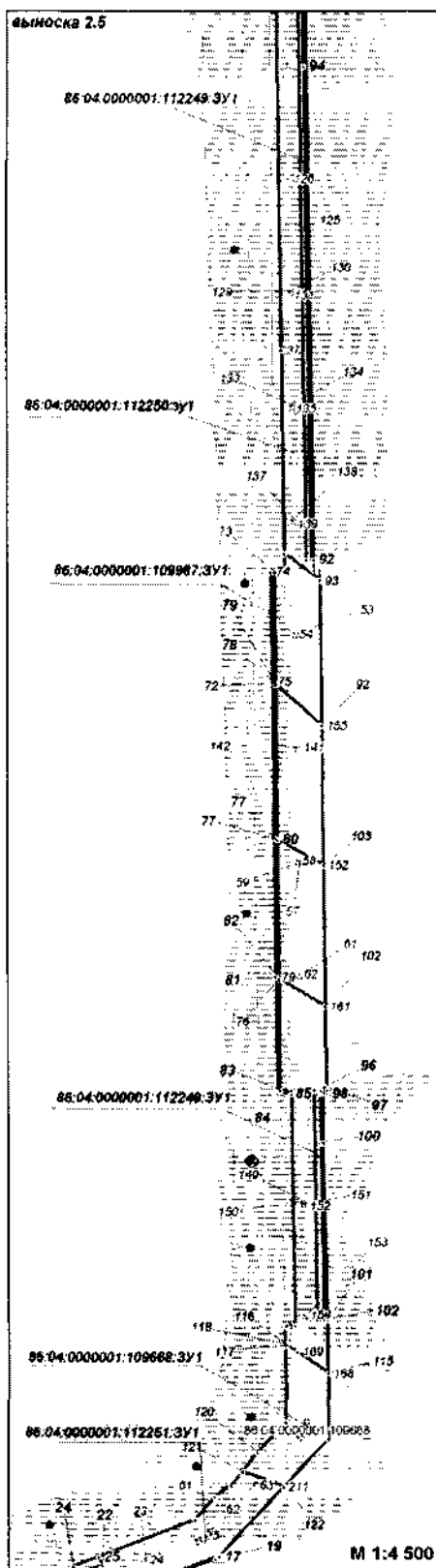

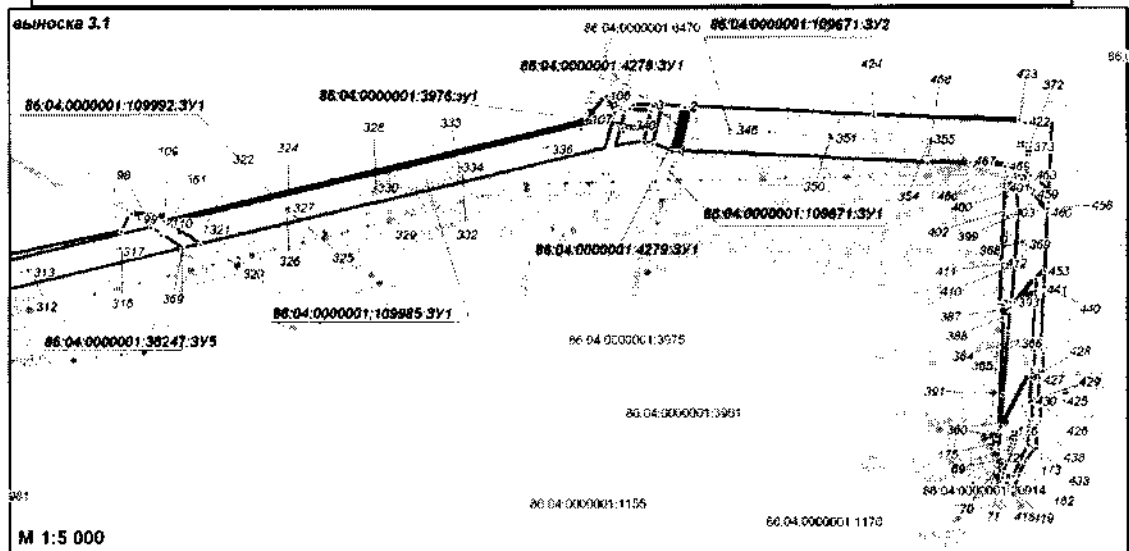
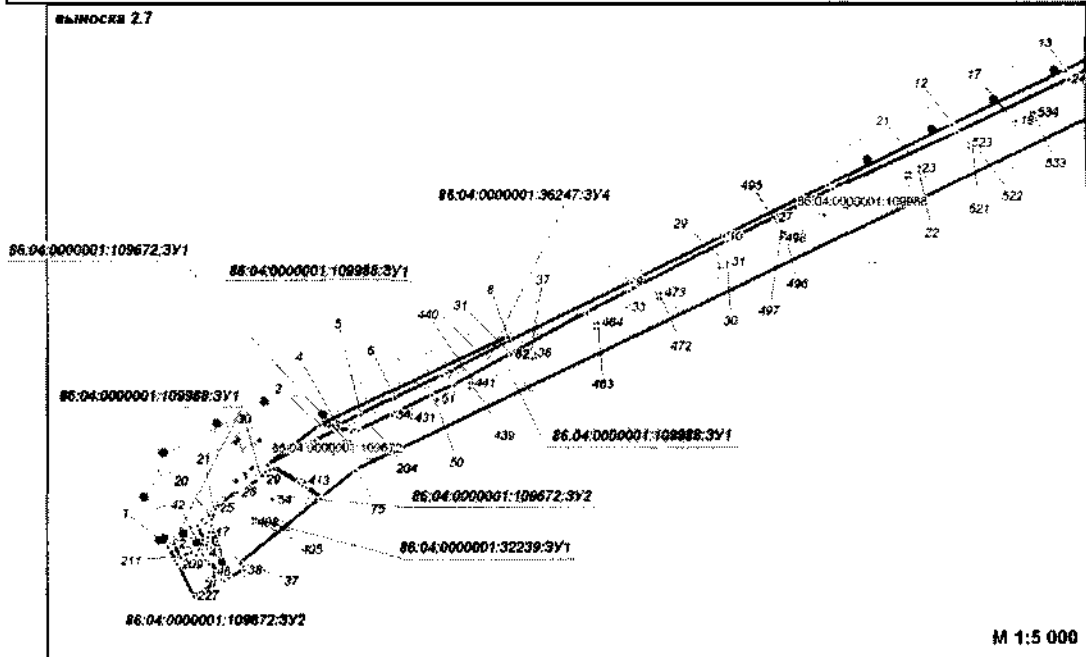
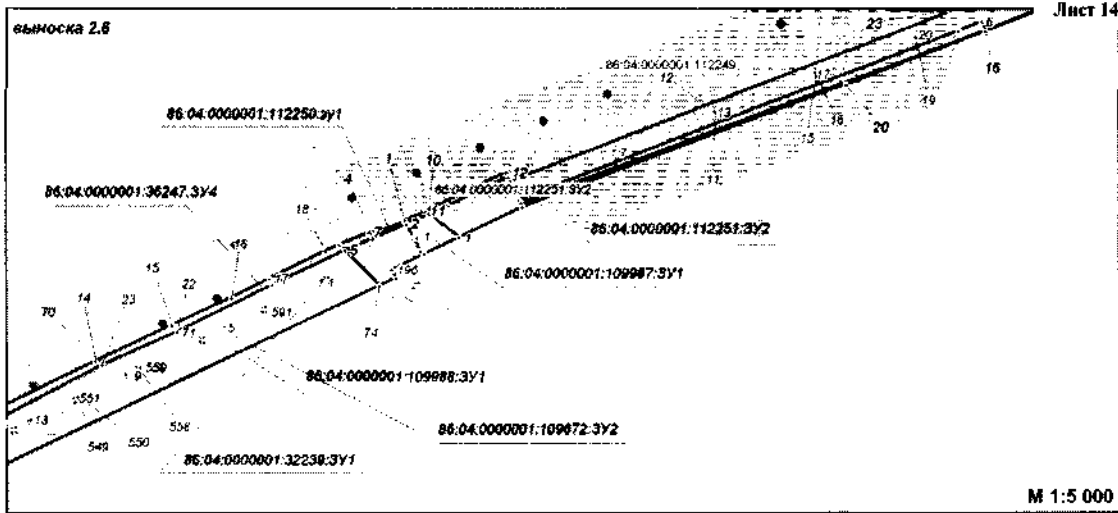

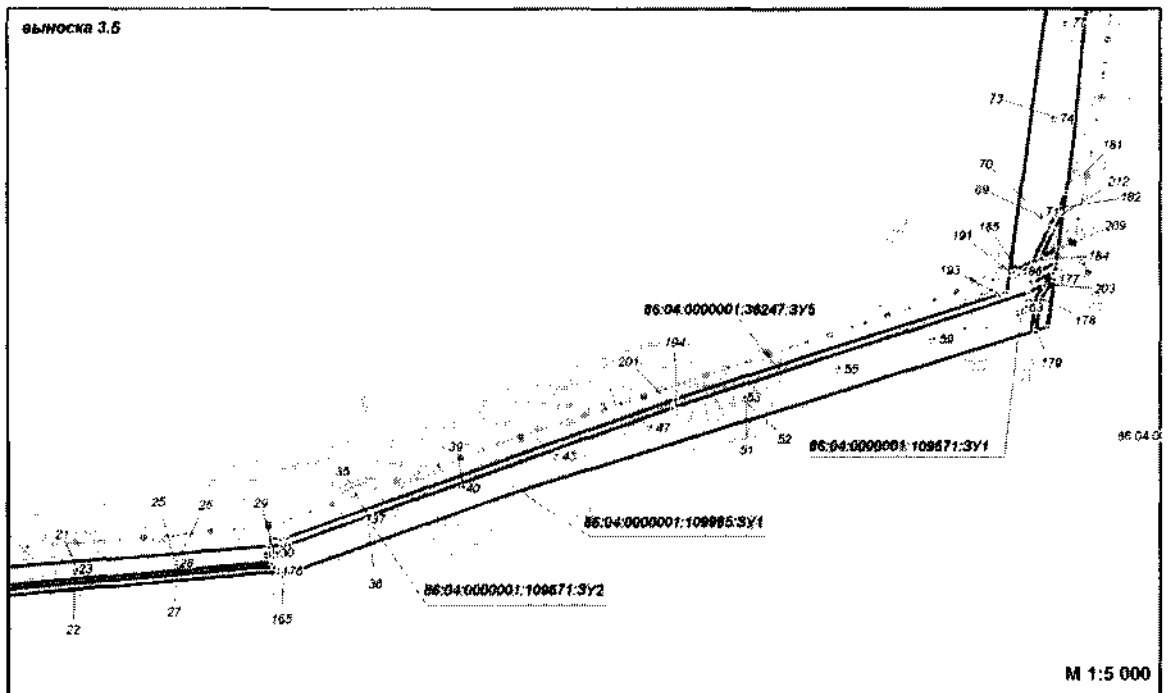
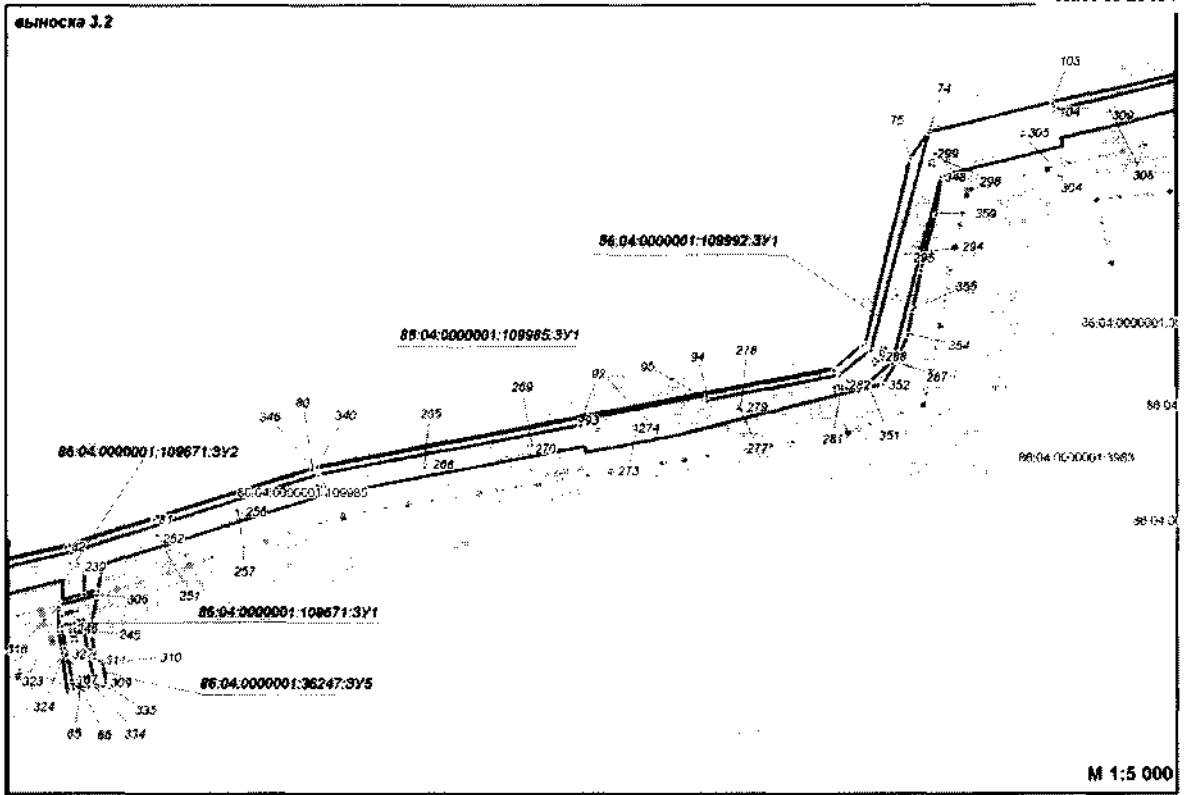

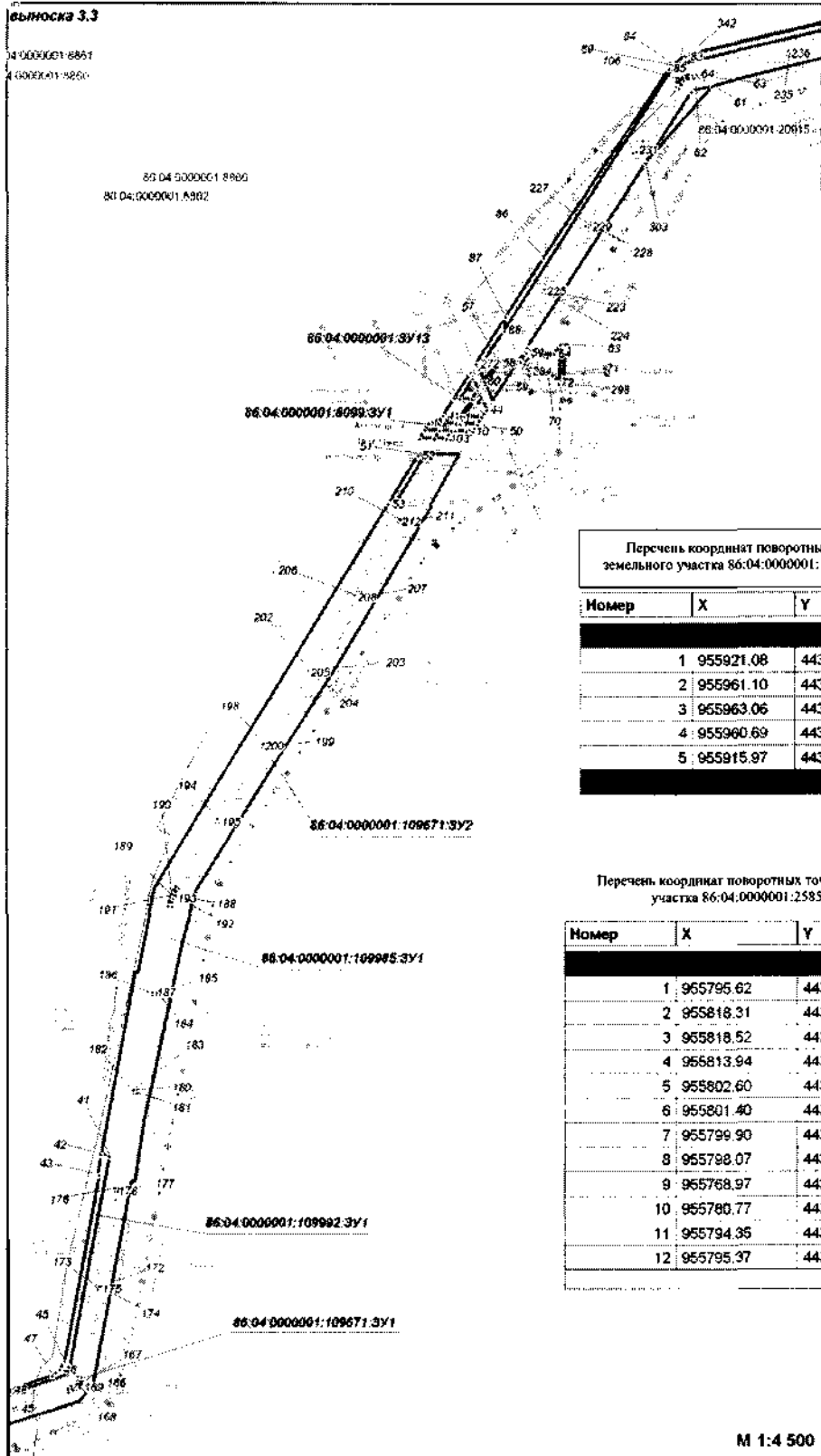

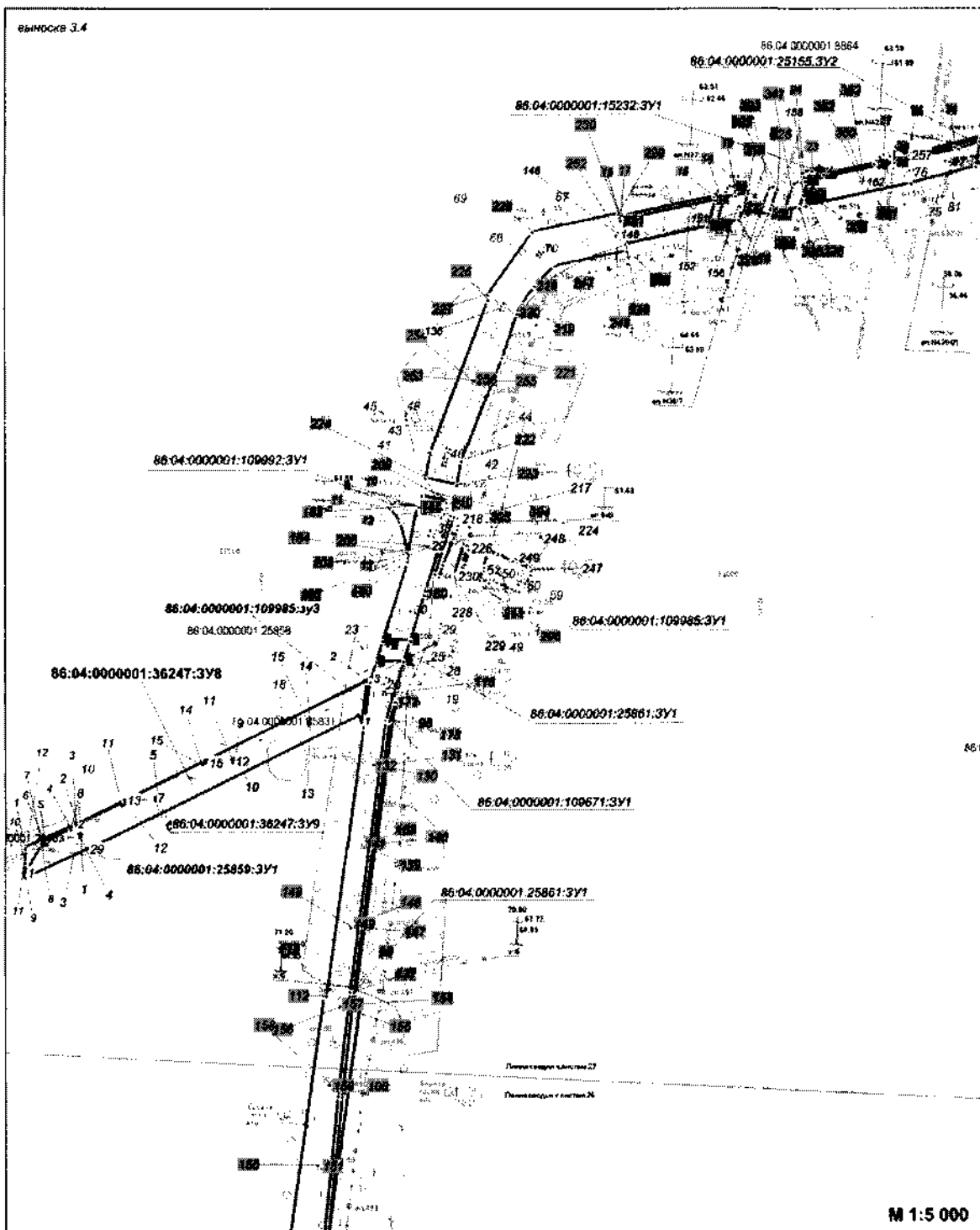

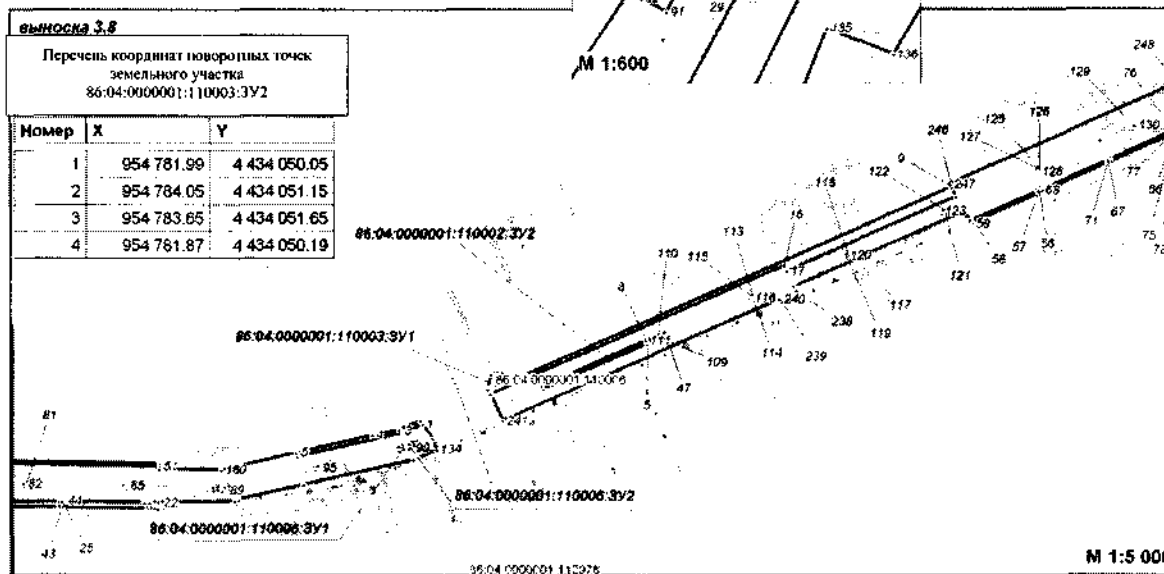
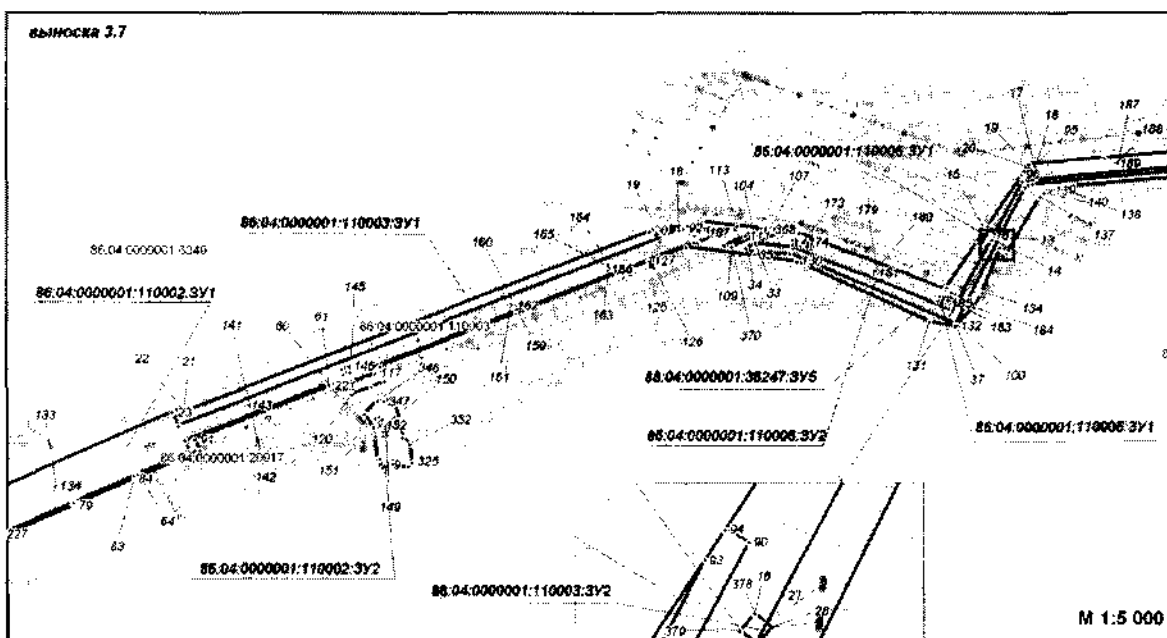
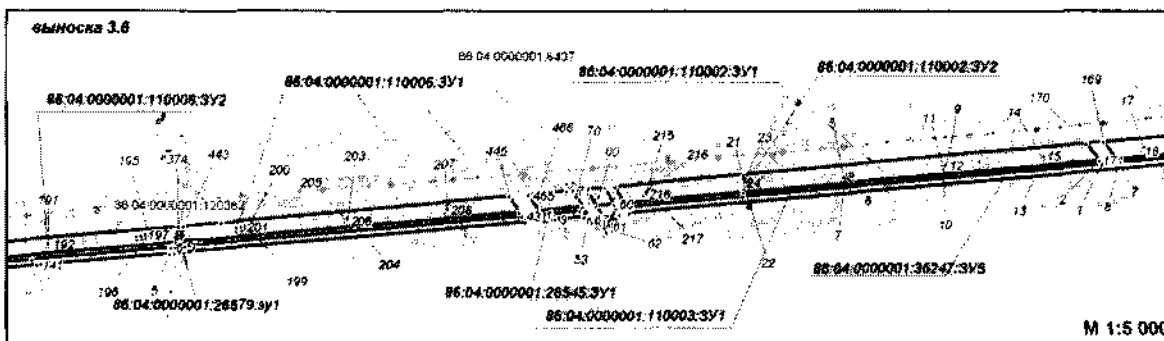

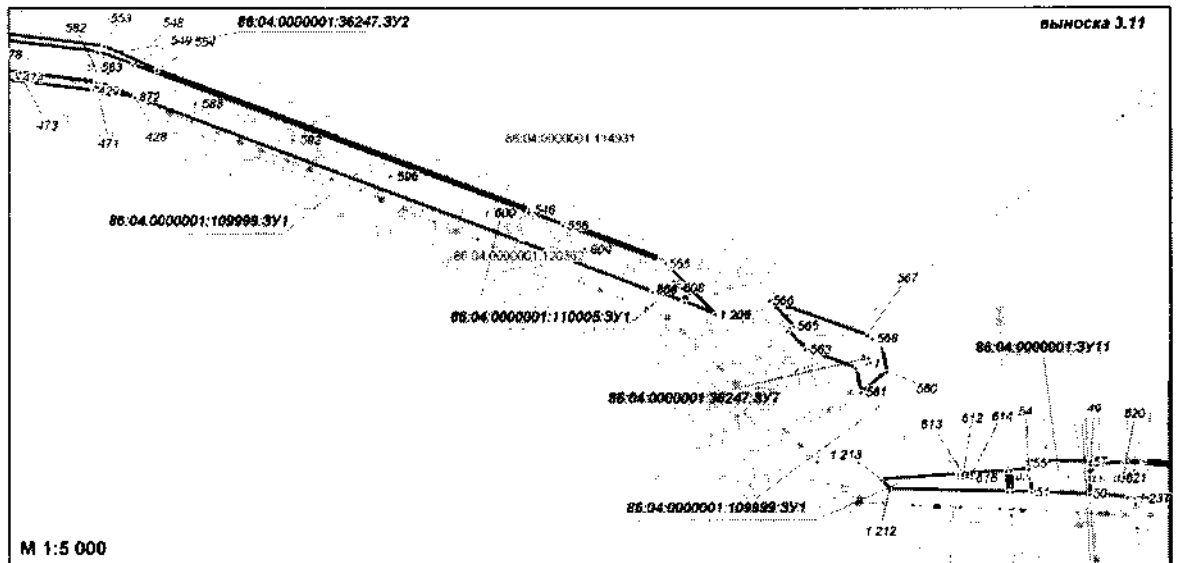
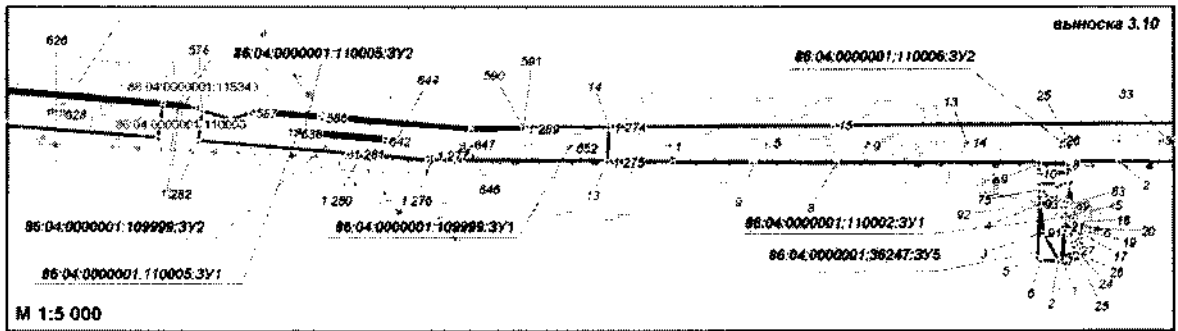
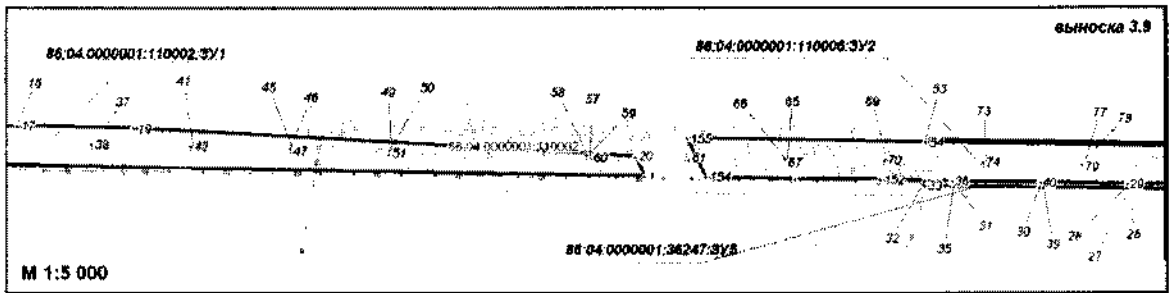

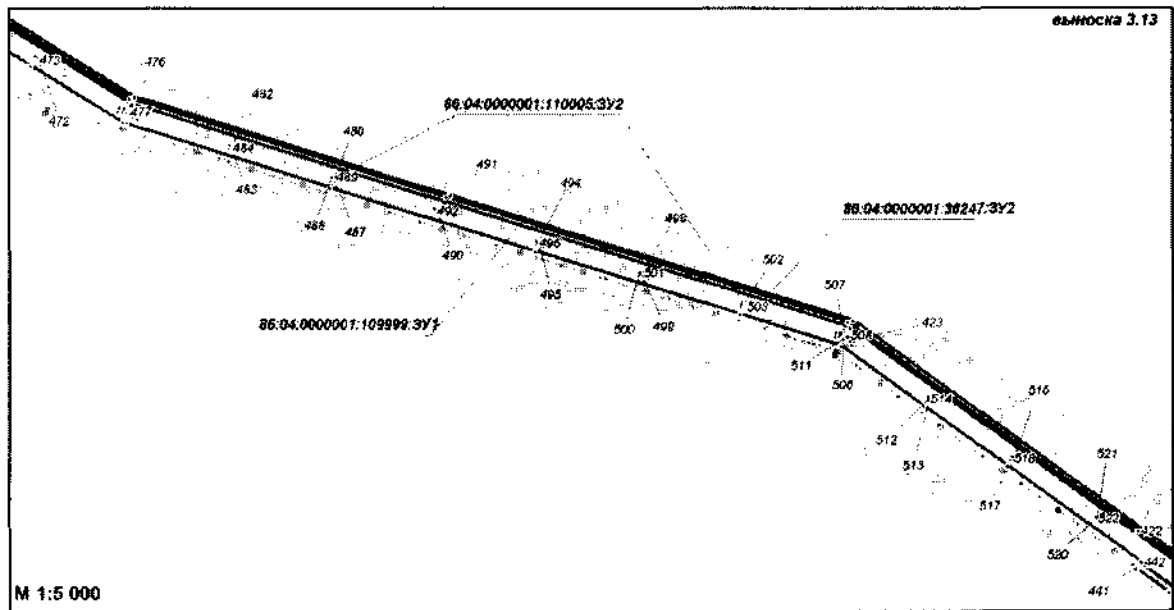
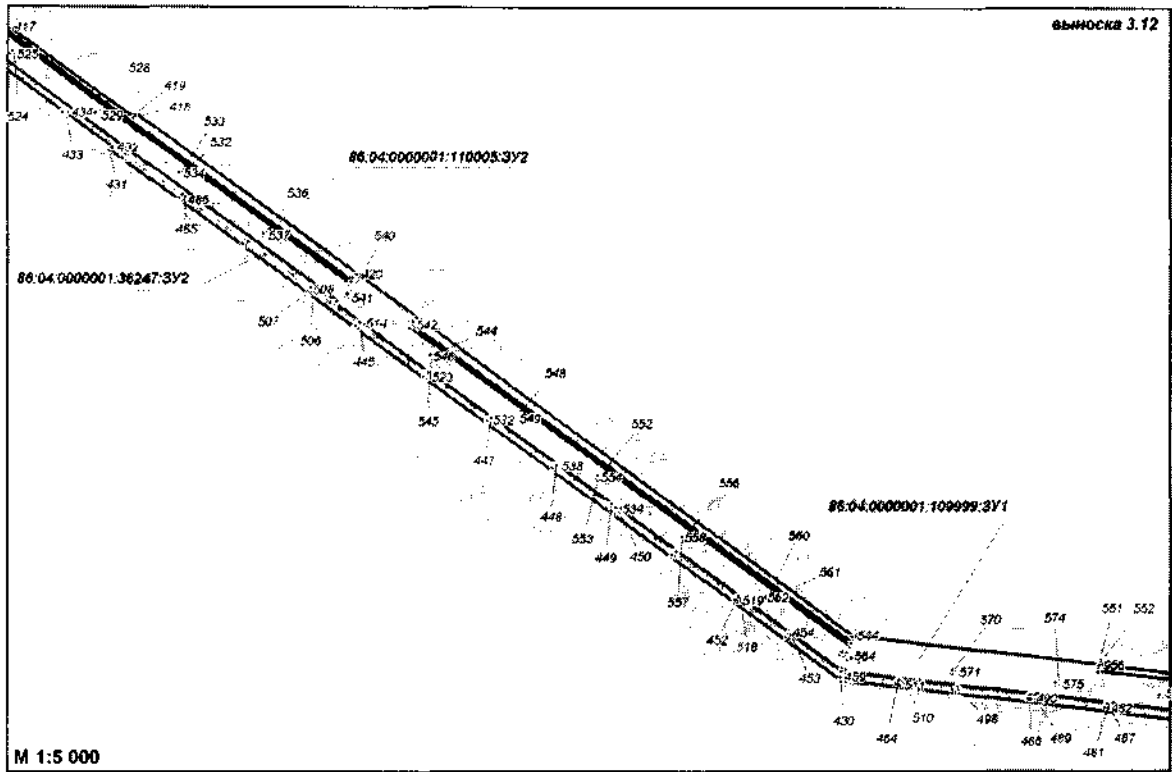

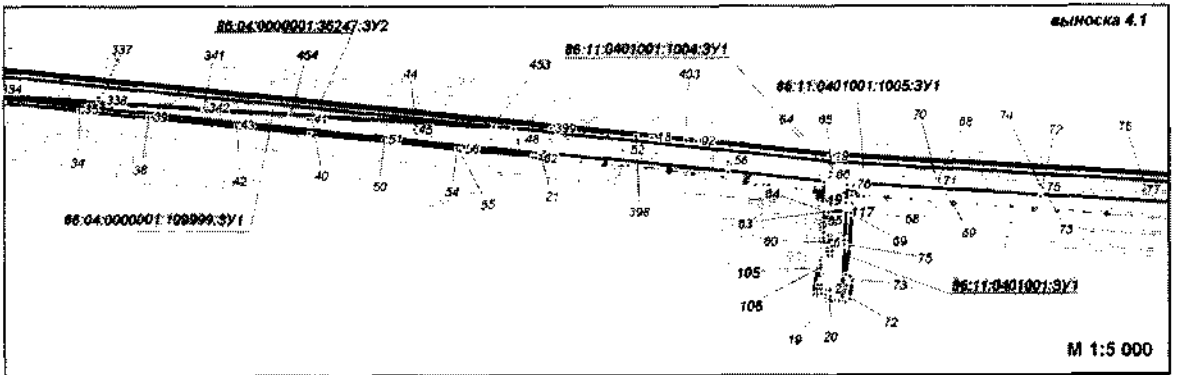
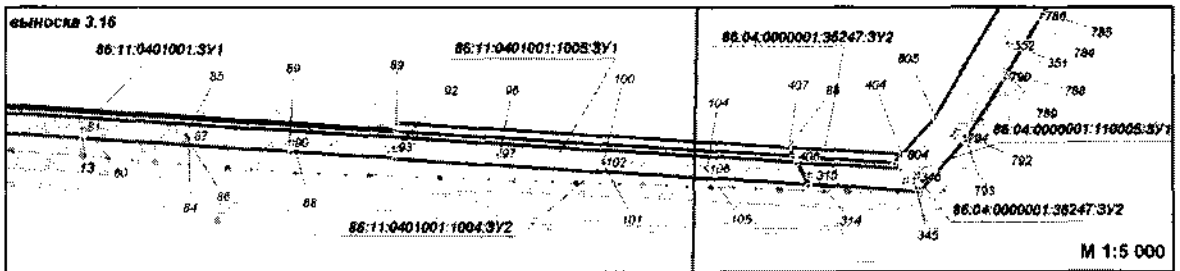
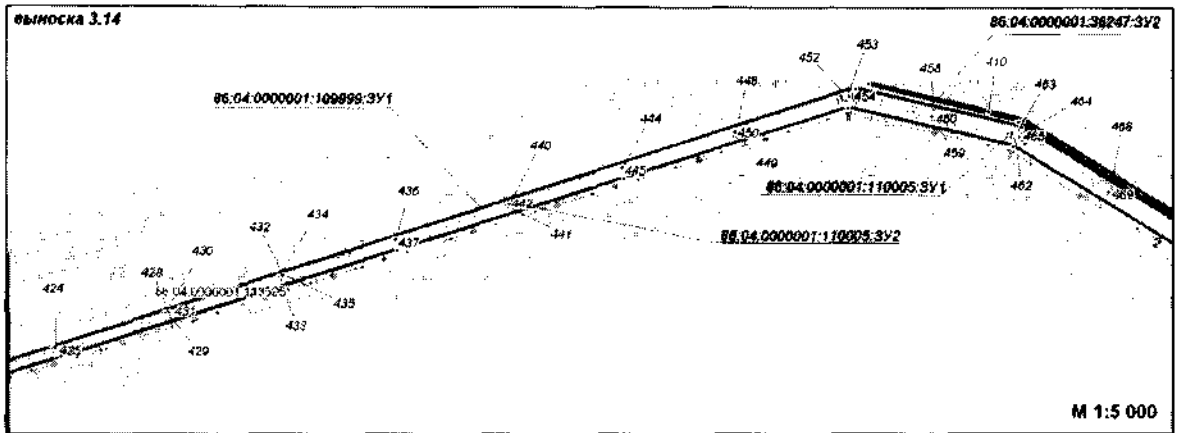

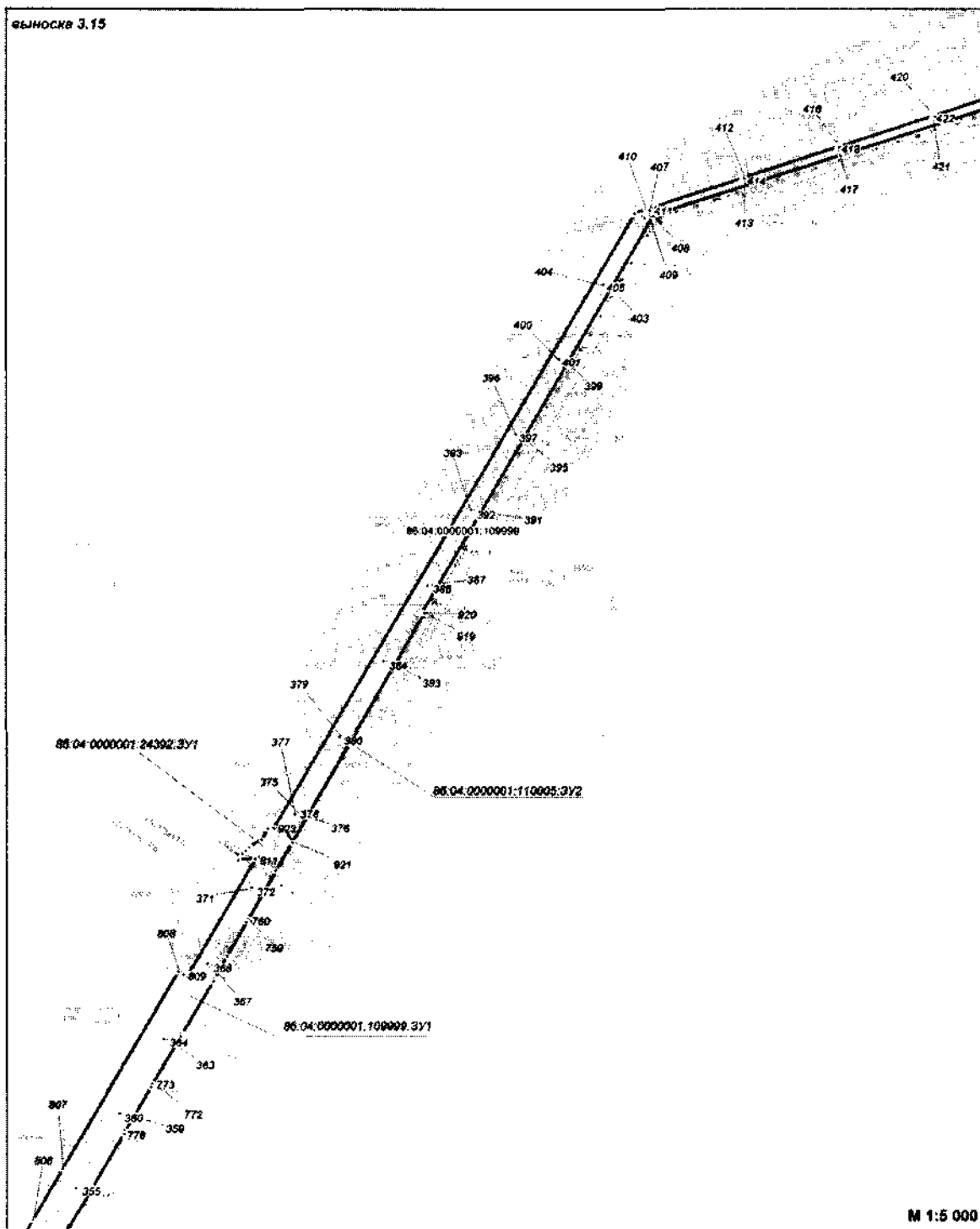

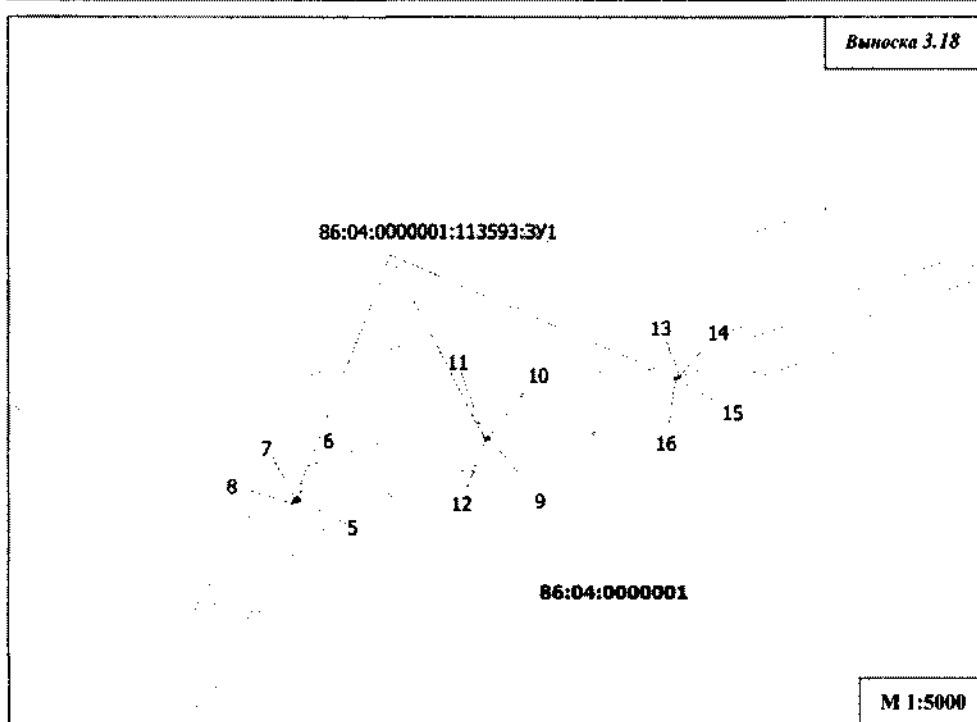
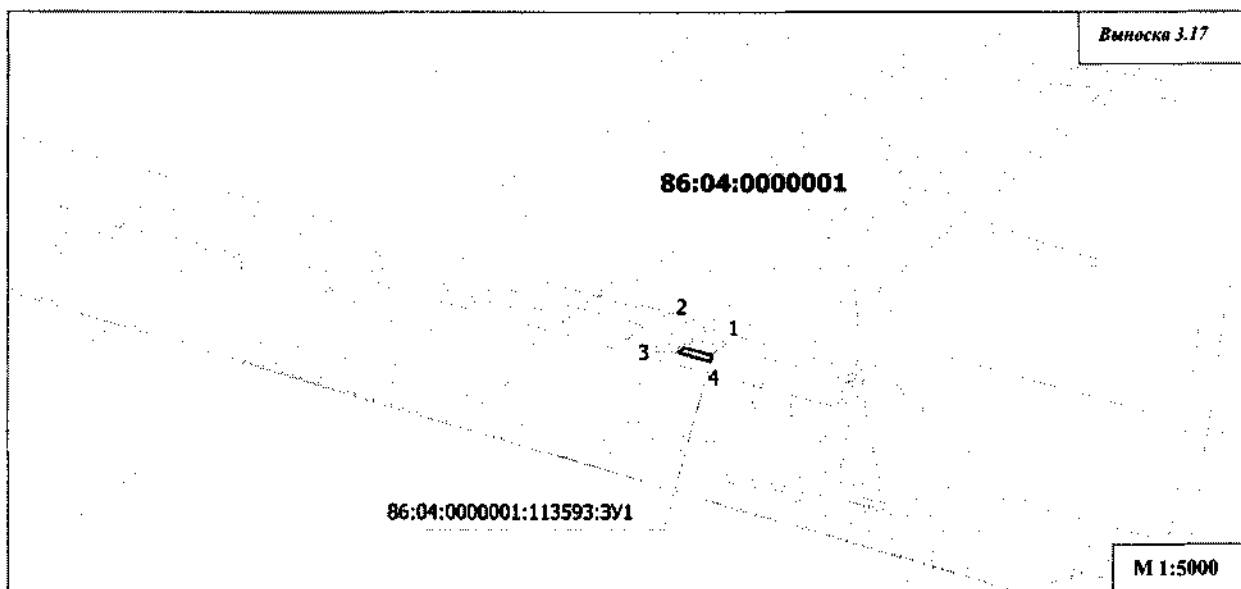

Перечень координат поворотных точек земельного участка с КН

86:04:0000001:113593:3У1

Номер точки	X	Y	Номер точки	X	Y
1	955429	4417141,96	11	955444,16	4426102,89
2	955432,64	4417128,35	12	955443,46	4426103,12
3	955430,29	4417125,49	13	955474,74	4426200,27
4	955426,11	4417141,2	14	955474,93	4426200,2
5	955413,68	4426010,65	15	955474,27	4426198,1
6	955415,14	4426009,75	16	955474,06	4426198,17
7	955414,71	4426008,32	17	954296,19	4430040,53
8	955412,5	4426006,97	18	954296,25	4430036,8
9	955444,12	4426105,22	19	954293,34	4430037,36
10	955444,83	4426104,99	20	954293,19	4430040,39

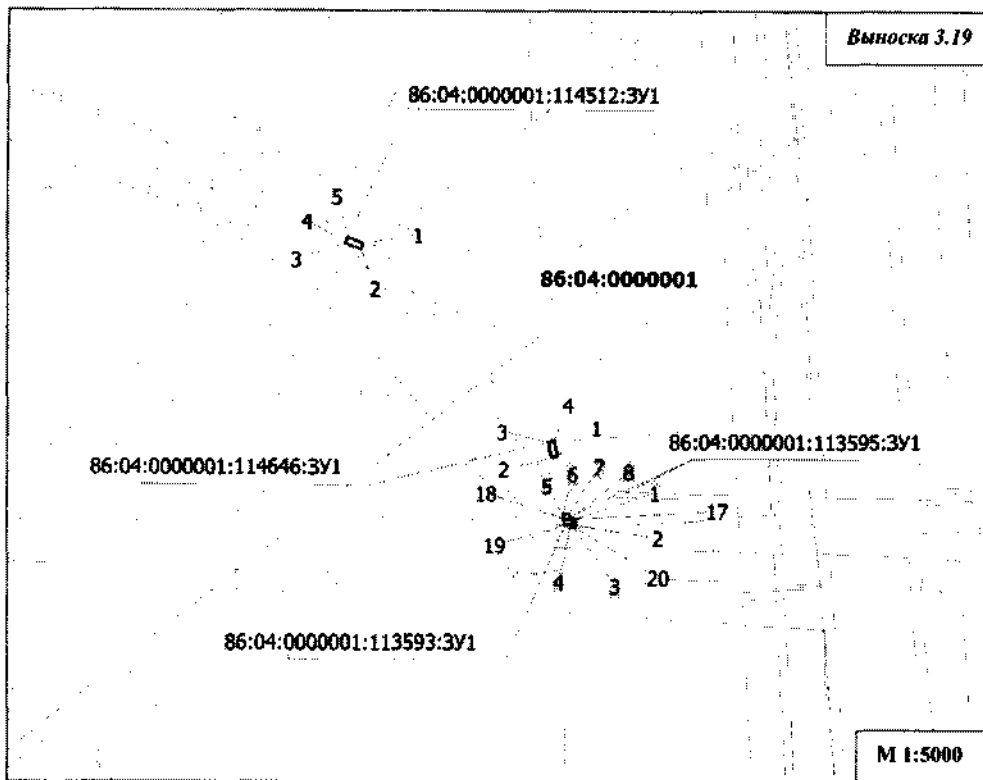

Перечень координат поворотных точек земельного участка с КН 86:04:0000001:114512:3У1			Перечень координат поворотных точек земельного участка с КН 86:04:0000001:114646:3У1			Перечень координат поворотных точек земельного участка с КН 86:04:0000001:113595:3У1		
Номер точки	X	Y	Номер точки	X	Y	Номер точки	X	Y
1	954424,97	4429941,45	1	954325,68	4430033,64	1	954296,17	4430042,31
2	954422,2	4429940,32	2	954325,08	4430030,72	2	954293,17	4430042,25
3	954425,04	4429933,34	3	954332,47	4430029,17	3	954293,24	4430040,39
4	954425,06	4429933,32	4	954333,03	4430032,1	4	954296,18	4430040,53
5	954427,8	4429934,5				5	954296,25	4430036,8
						6	954298,34	4430036,38
						7	954298,64	4430039,35
						8	954296,22	4430039,84

Выписка 3.20

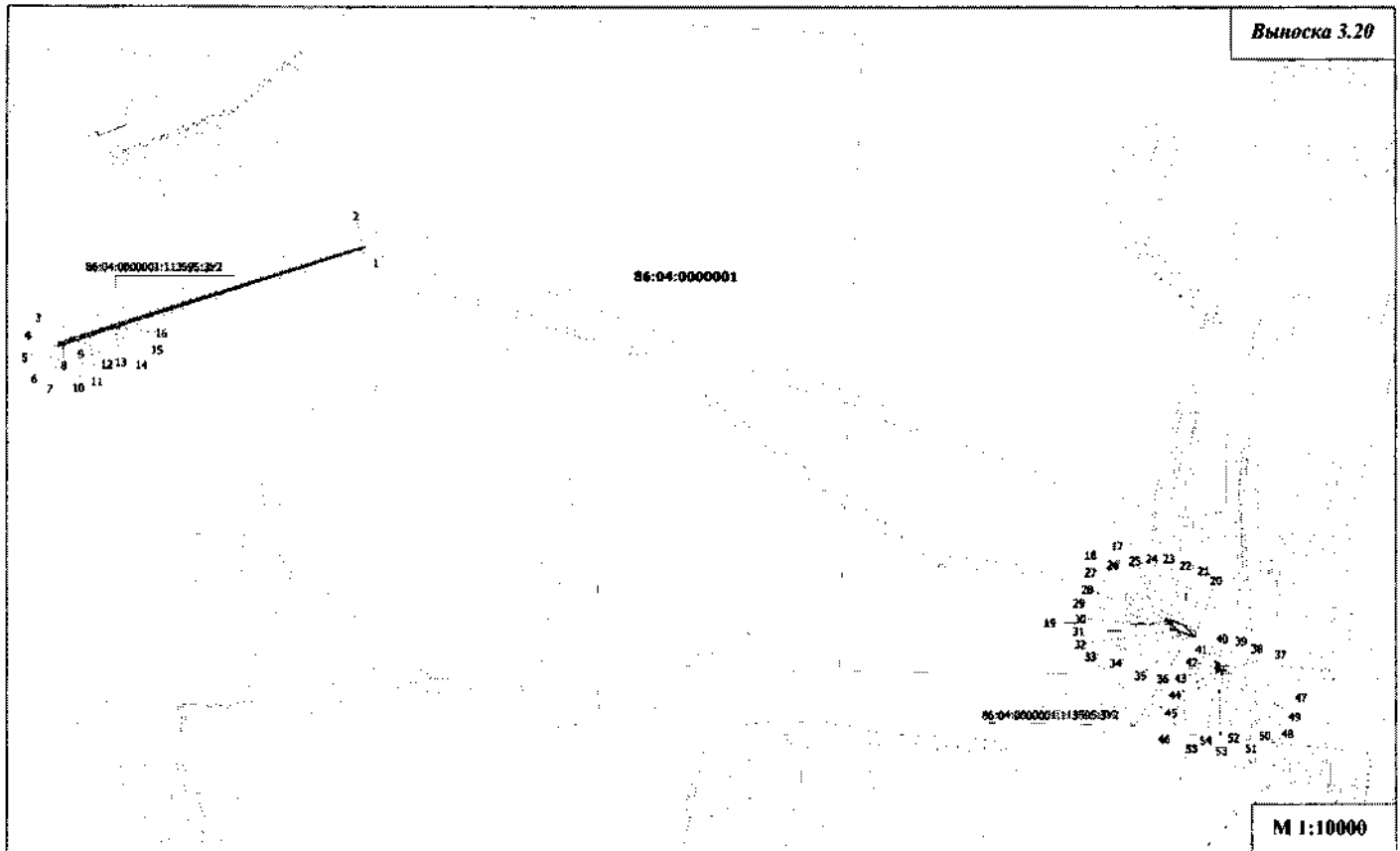

Перечень координат поворотных точек земельного участка с КН
86:04:000001:113595:3У2

Номер точки	X	Y	Номер точки	X	Y
1	955752,22	4427062,18	28	954450,25	4429870,7
2	955753,67	4427055,91	29	954449,82	4429870,5
3	955420,9	4426003,01	30	954449,82	4429870,5
4	955408,94	4425995,92	31	954432,77	4429887,4
5	955412,5	4426006,97	32	954430,32	4429889,9
6	955414,7	4426008,32	33	954419	4429919,1
7	955417,29	4426016,73	34	954421,37	4429920,5
8	955415,79	4426017,19	35	954417,04	4429927,9
9	955443,46	4426103,12	36	954414,82	4429929,9
10	955444,18	4426102,89	37	954292,67	4430052,7
11	955444,83	4426104,99	38	954306,53	4430049,8
12	955444,12	4426105,22	39	954306,77	4430037,6
13	955474,06	4426198,17	40	954311,48	4430033,5
14	955474,28	4426198,1	41	954325,11	4430021,5
15	955474,94	4426200,2	42	954301,45	4430026,8
16	955474,74	4426200,26	43	954302,27	4430027,8
17	954463,33	4429872,4	44	954296,33	4430032,7
18	954472,3	4429848,12	45	954296,25	4430036,8
19	954452,53	4429867,8	46	954298,34	4430036,4
20	954407,45	4429948,86	47	954298,65	4430039,4
21	954425,05	4429933,32	48	954296,22	4430039,8
22	954436,22	4429923,48	49	954296,17	4430042,3
23	954448,12	4429912,97	50	954293,18	4430042,3
24	954454,61	4429895,5	51	954293,25	4430040,4
25	954458,91	4429883,88	52	954293,19	4430040,4
26	954462,49	4429874,22	53	954293,62	4430031,3
27	954451,09	4429869,36	54	954297,87	4430027,6
			55	954291,07	4430029,1

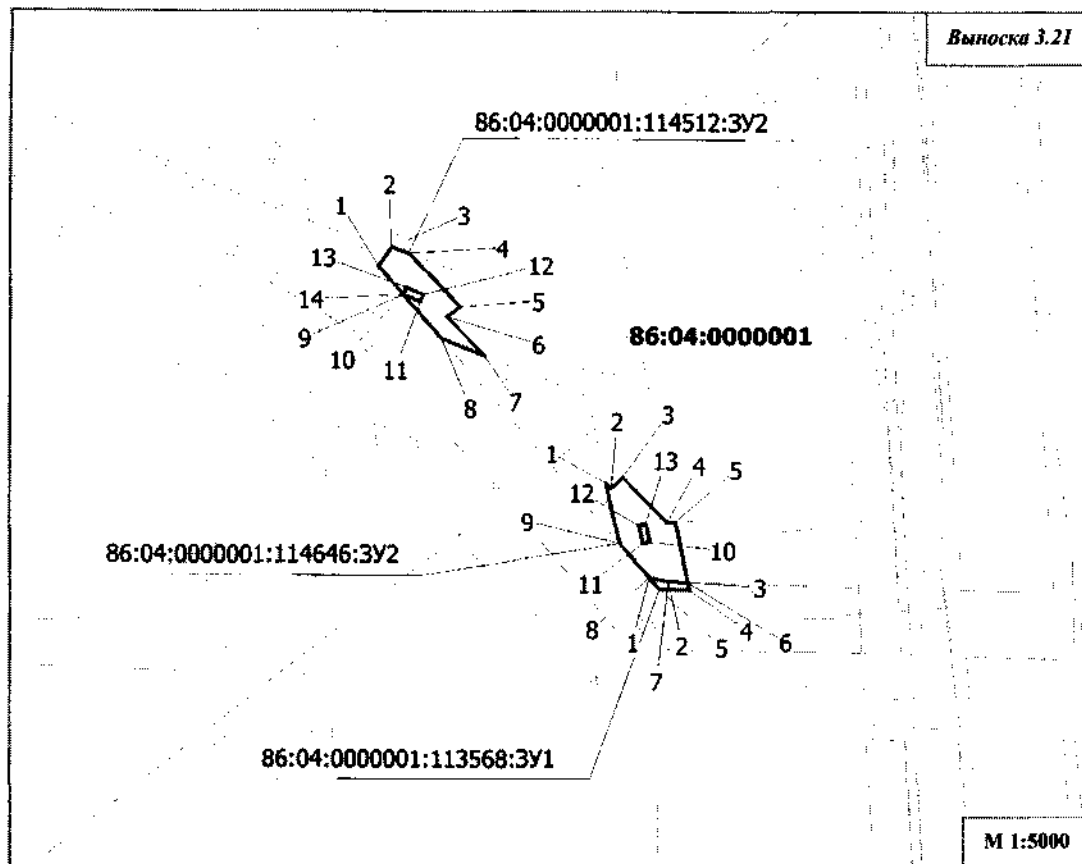

Перечень координат поворотных точек земельного участка с КН
86:04:0000001:114512:3У2

Номер точки	X	Y
1	954436,22	4429923,48
2	954443,75	4429928,66
3	954443,98	4429928,79
4	954441,52	4429935,77
5	954420,15	4429956,5
6	954416,31	4429951,17
7	954400,66	4429966,35
8	954407,45	4429948,86
9	954425,05	4429933,33
10	954425,05	4429933,34
11	954422,2	4429940,32
12	954424,97	4429941,45
13	954427,8	4429934,5
14	954425,06	4429933,32

Перечень координат поворотных точек земельного участка с КН
86:04:0000001:114646:3У2

Номер точки	X	Y
1	954349,53	4430015,97
2	954347,4	4430018,05
3	954351,87	4430022,77
4	954333,45	4430040,65
5	954333,67	4430044,1
6	954309,58	4430049,12
7	954309,83	4430041,18
8	954311,48	4430033,48
9	954325,12	4430021,46
10	954325,68	4430033,64
11	954325,07	4430030,72
12	954332,47	4430029,17
13	954333,04	4430032,1

Перечень координат поворотных точек земельного участка с КН
86:04:0000001:113568:3У1

Номер точки	X	Y
1	954311,48	4430033,48
2	954309,83	4430041,18
3	954309,58	4430049,12
4	954306,53	4430049,76
5	954306,77	4430037,61

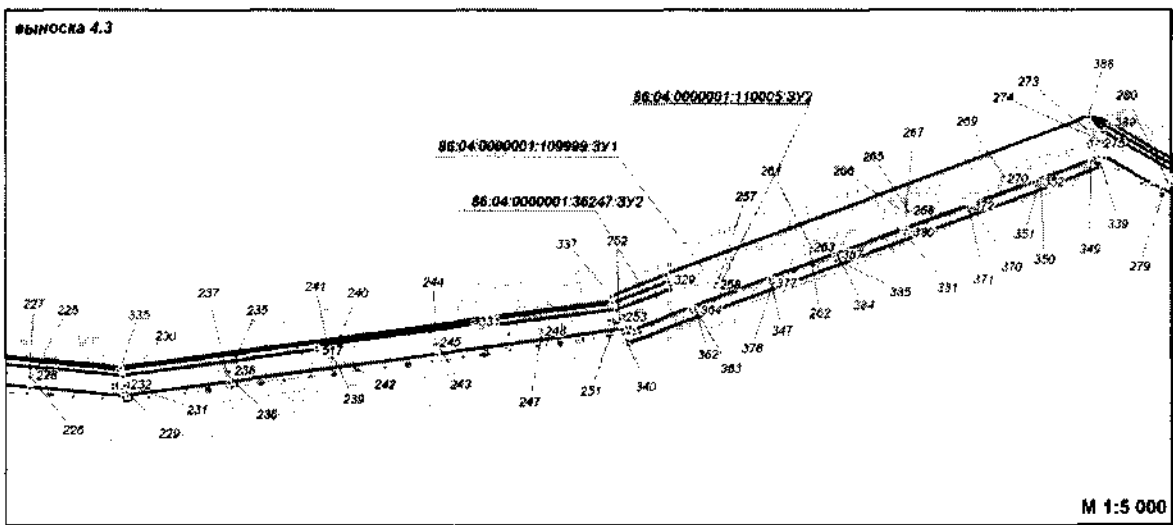
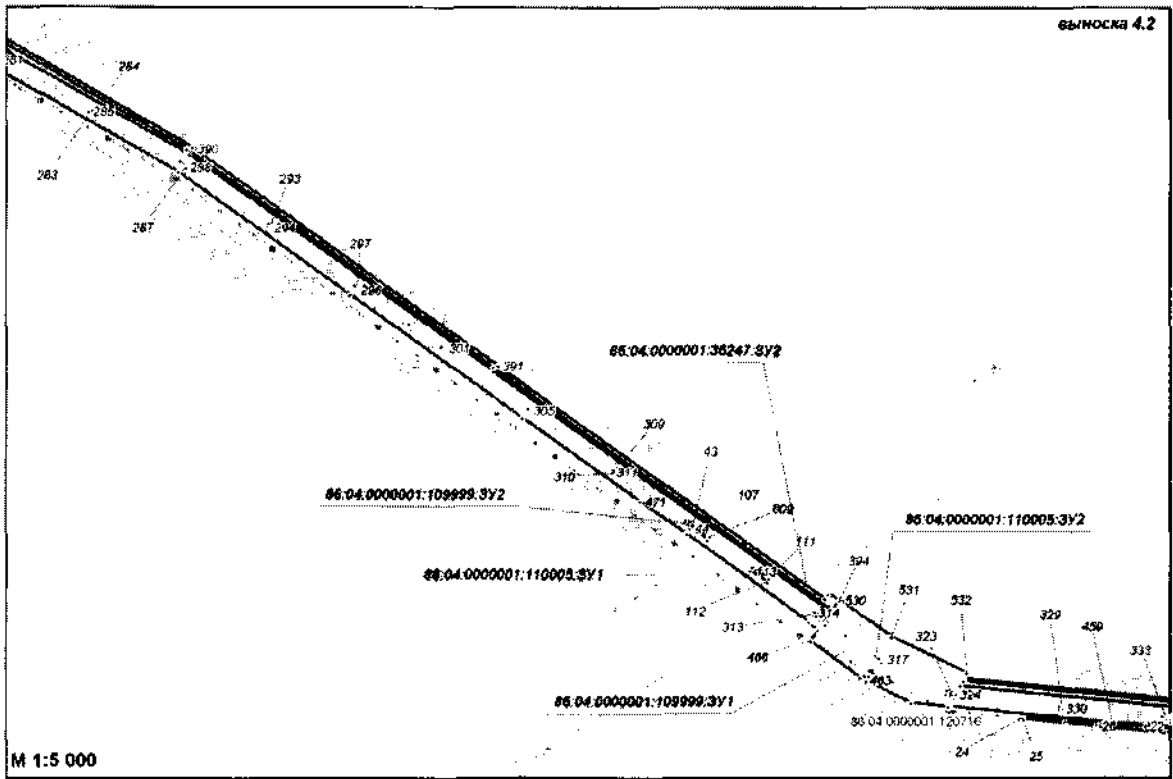

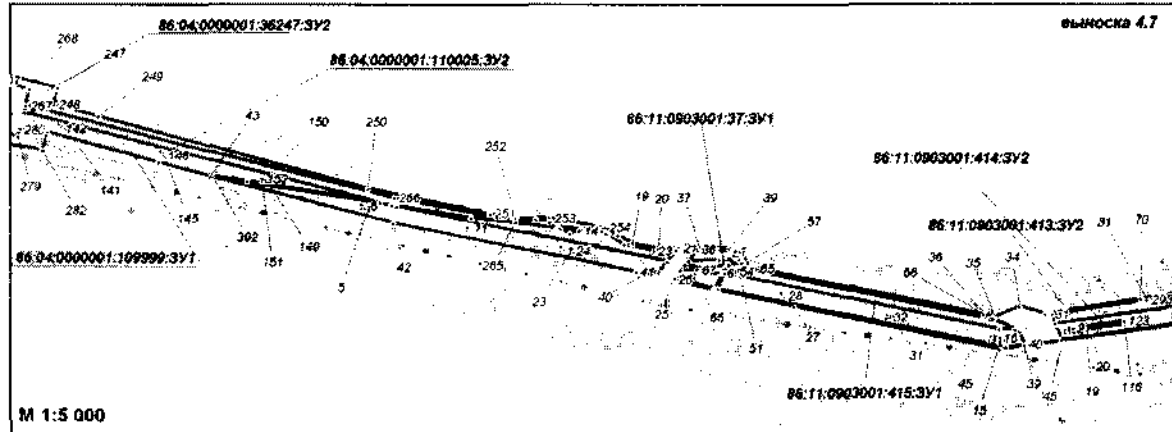
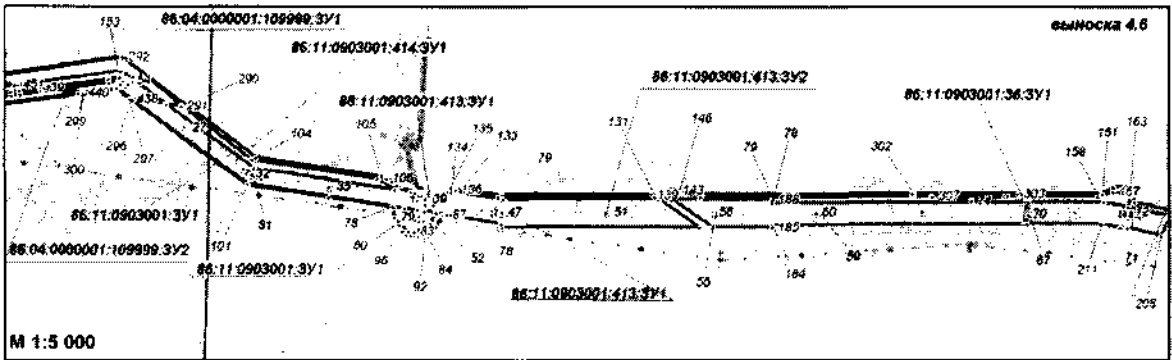
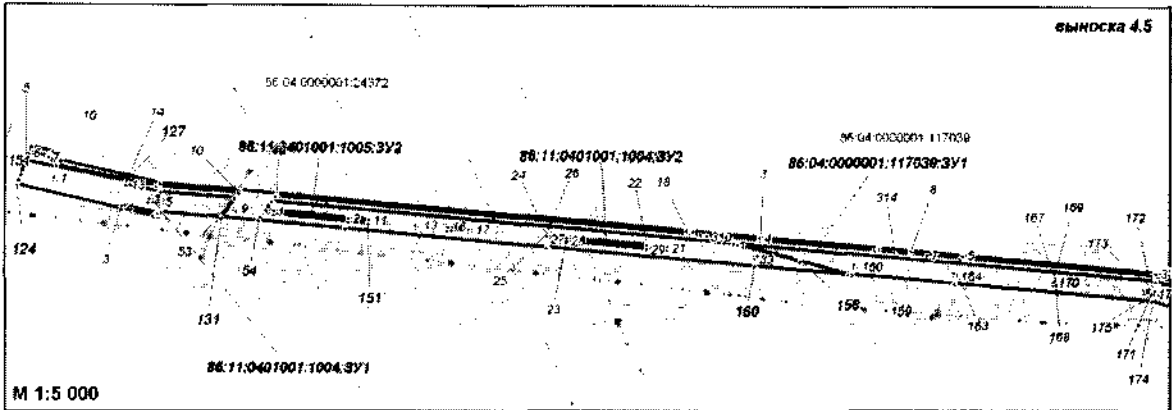
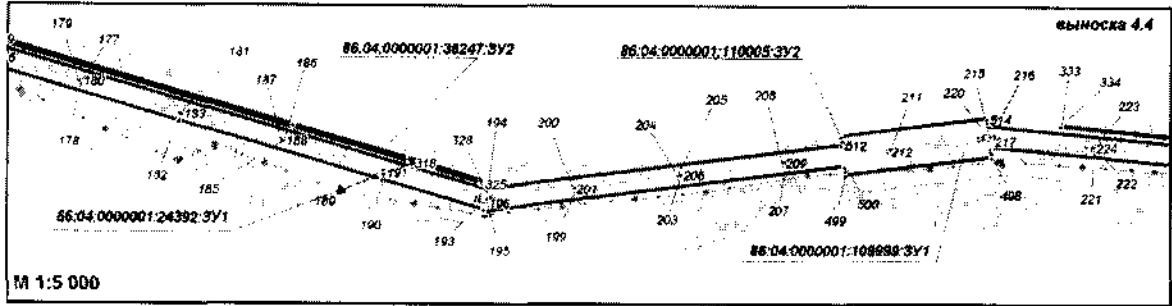

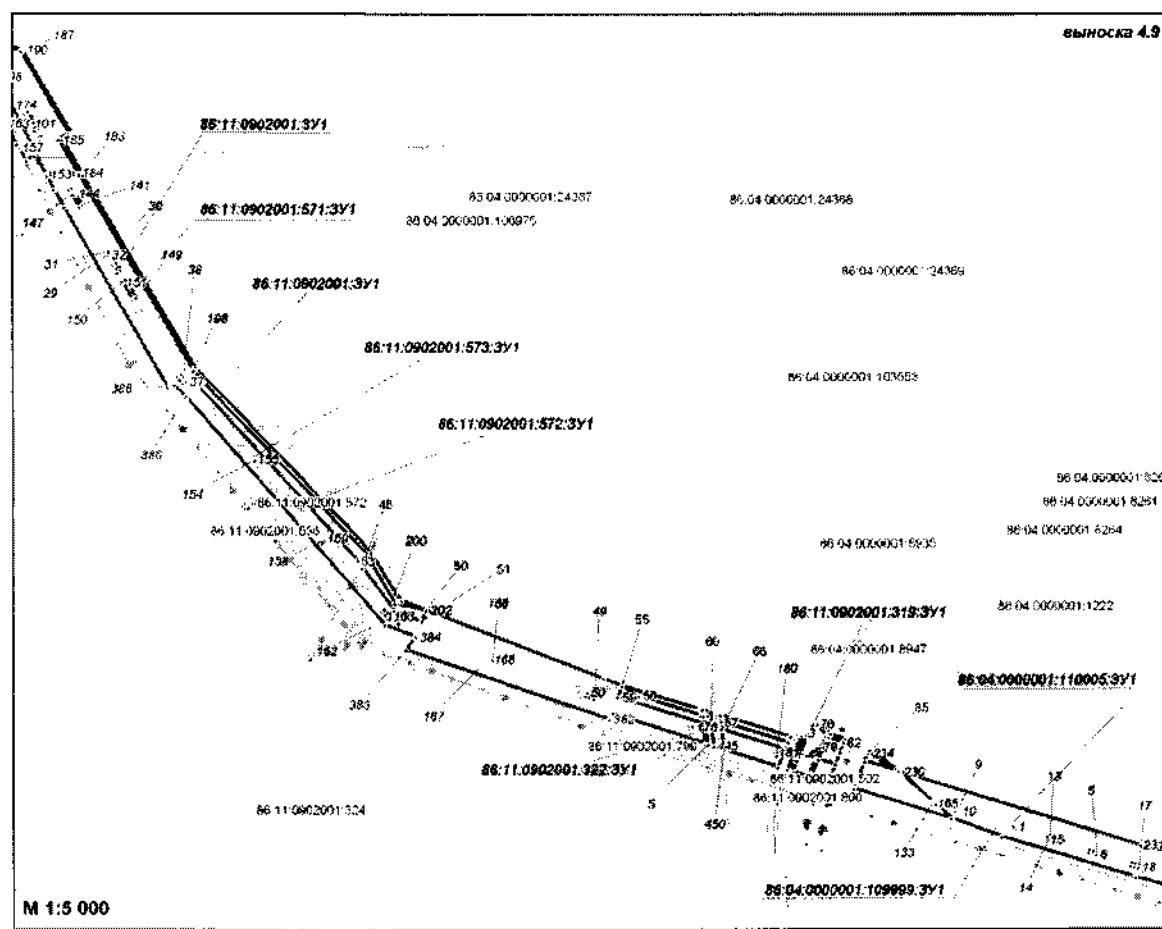
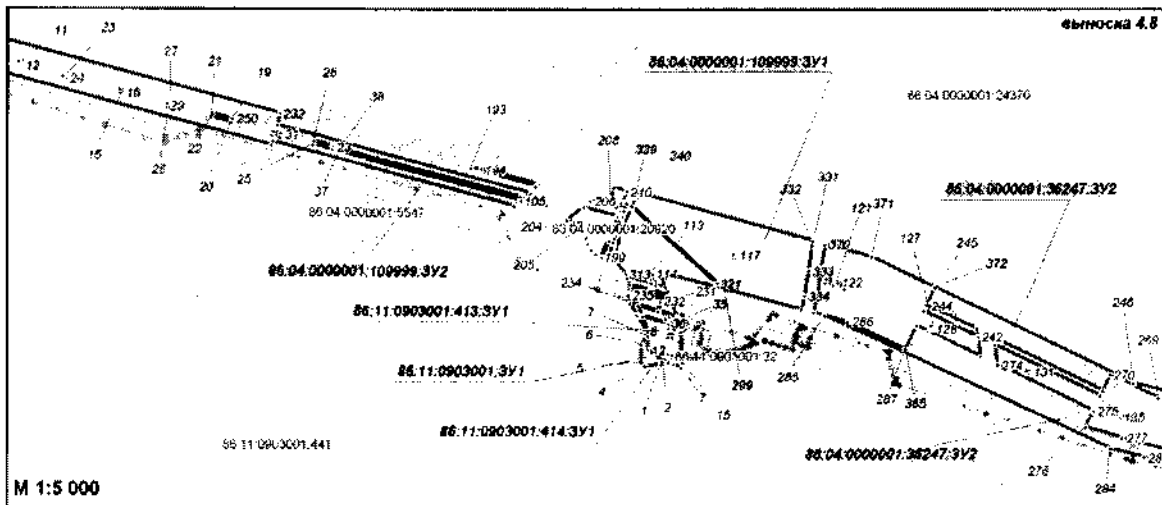

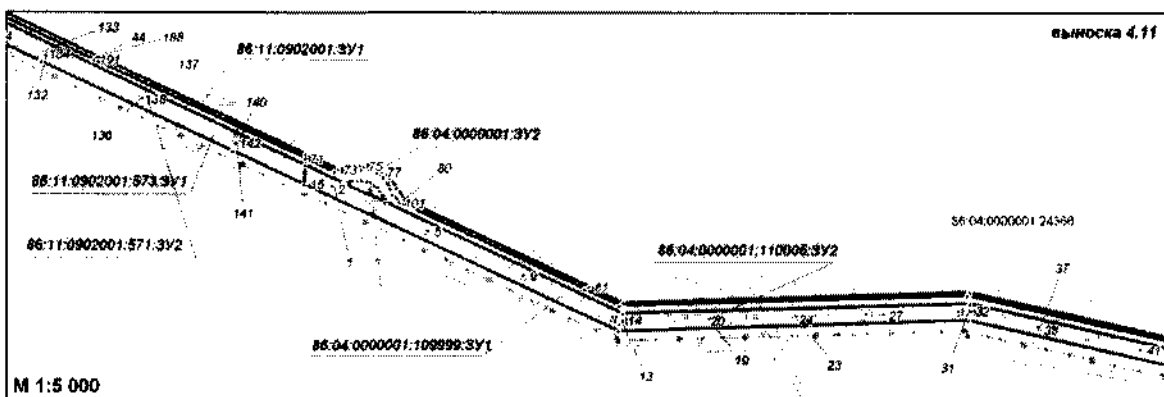
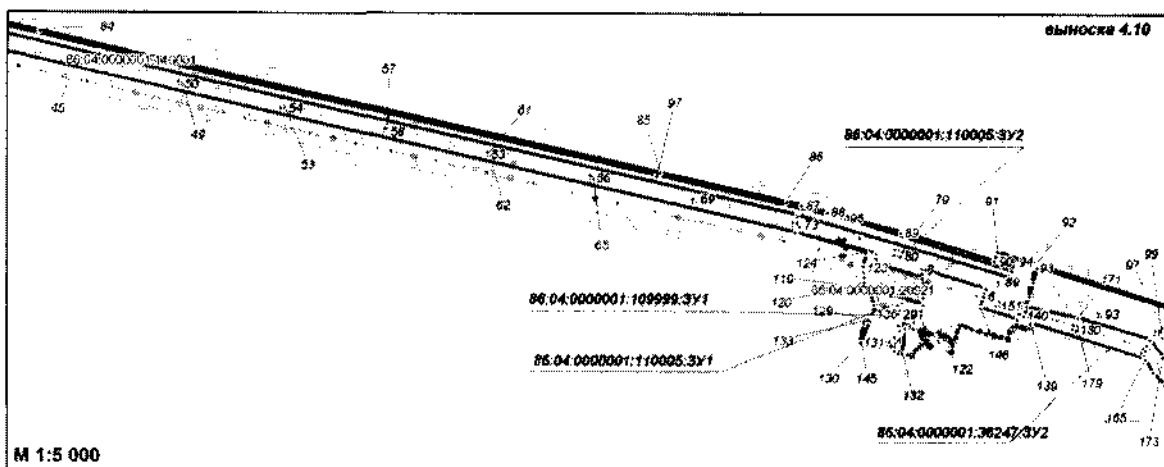

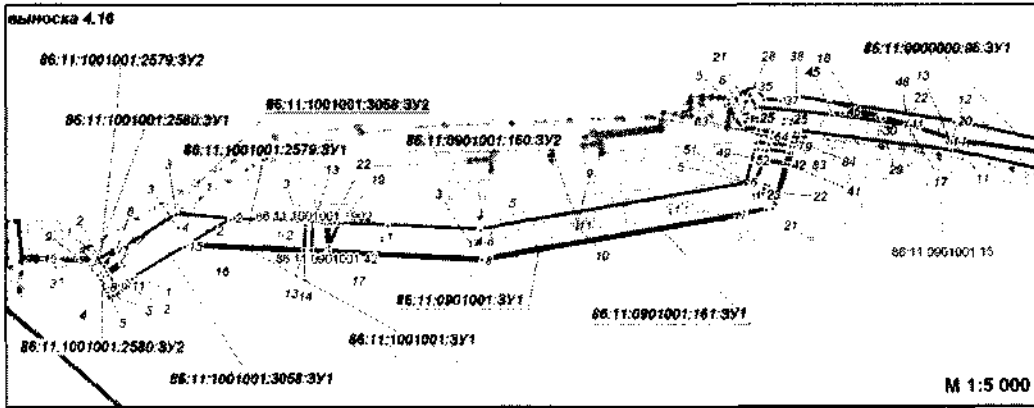
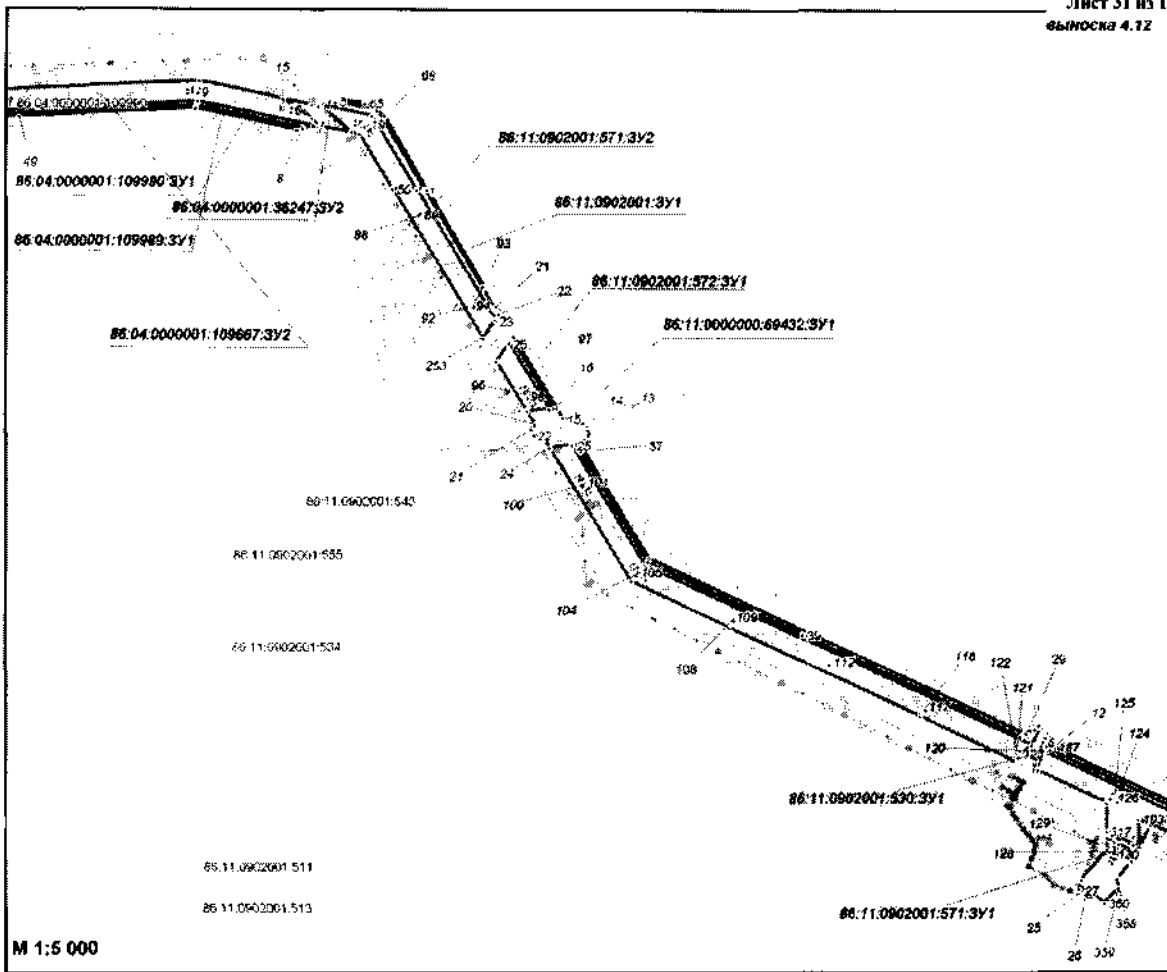

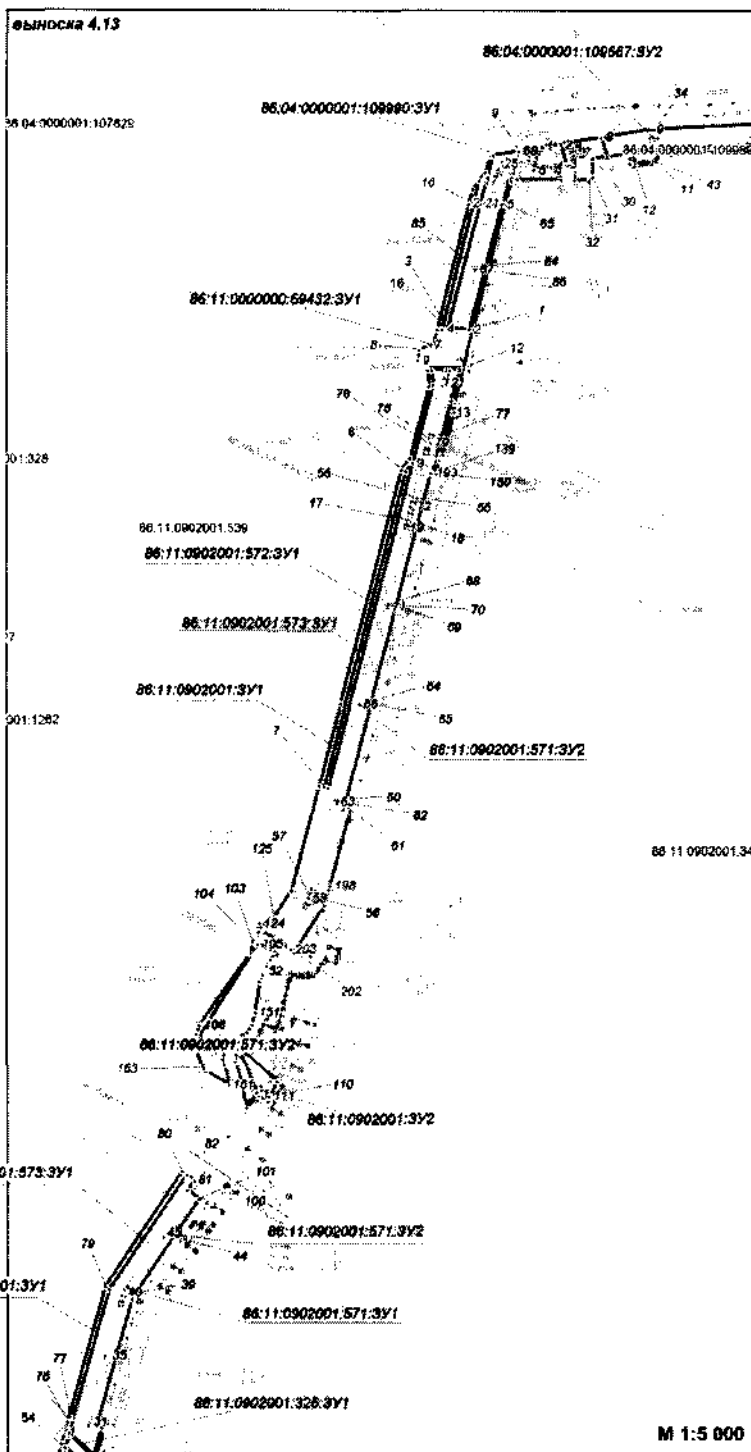

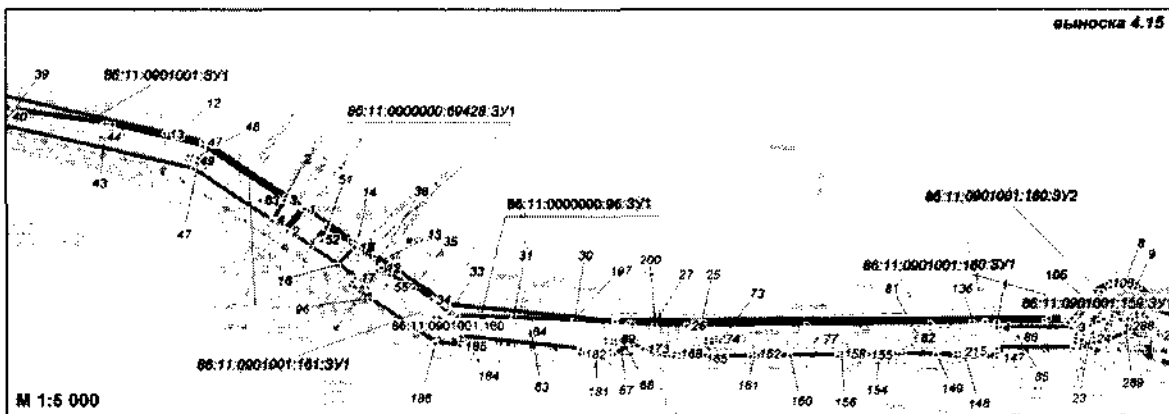
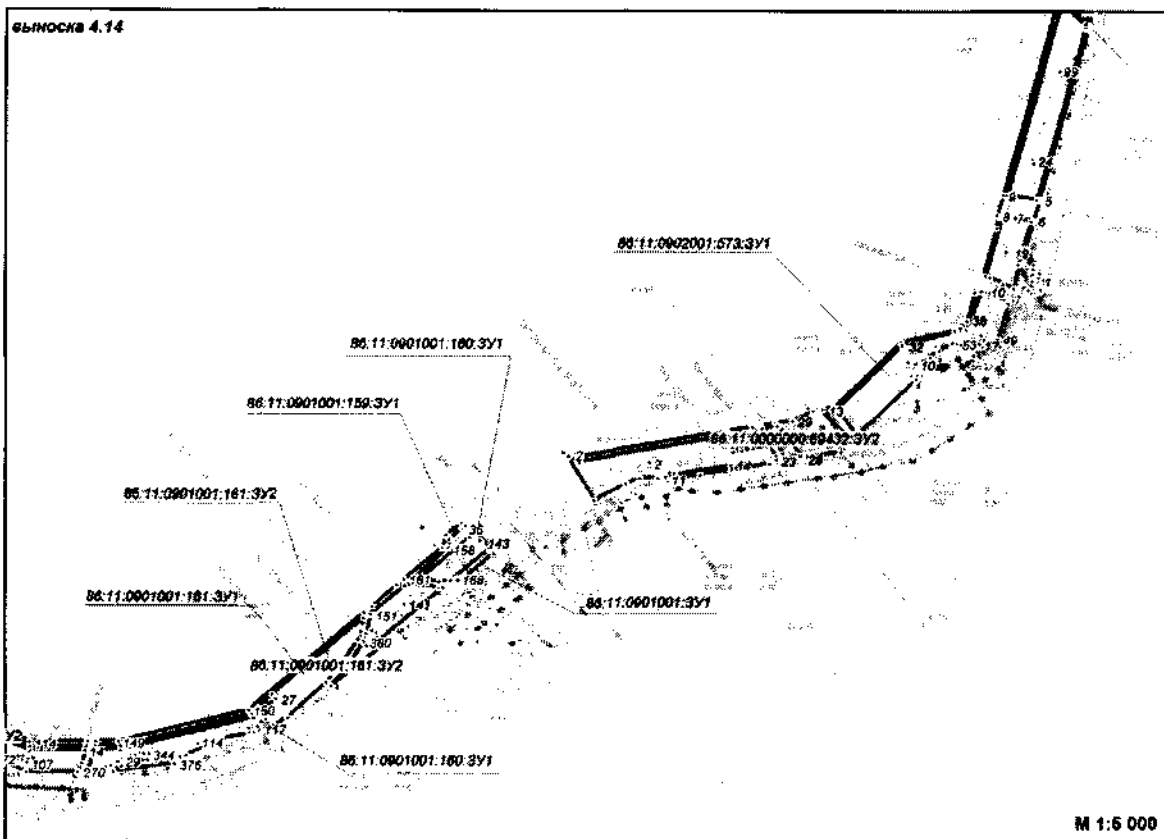

Перечень координат поворотных точек земельного участка

Номер	X	Y	Номер	X	Y
1	959 802.04	4 449 800.9	60	961 395.06	4 450 409.78
2	959 799.53	4 449 802.2	61	961 382.8	4 450 410.03
3	959 799.53	4 449 802.21	62	961 382.89	4 450 414.31
4	959 786.78	4 449 773.95	63	963 834.26	4 450 385.06
5	959 777.18	4 449 750.5	64	963 833.89	4 450 387.89
6	959 781.77	4 449 745.9	65	963 721	4 450 392.19
7	959 791.84	4 449 770.4	66	963 861.07	4 450 393.32
8	959 793.65	4 449 774.41	67	963 840.08	4 450 390.9
9	959 790.27	4 449 776.01	68	963 840.07	4 450 390.9
10	959 808.14	4 449 821.29	69	963 721.3	4 450 389.37
11	959 810.34	4 449 818.46	70	962 854.83	4 450 405.65
12	959 842.54	4 449 886.53	71	962 858.23	4 450 408.4
13	959 838.69	4 449 888.34	72	962 880.15	4 450 411.75
14	959 815.39	4 449 837.36	73	962 265.54	4 450 418.77
15	959 816.7	4 449 898.76	74	962 285.75	4 450 428.65
16	959 960.12	4 450 289.42	75	962 260.14	4 450 428.82
17	959 991.84	4 450 371.89	76	962 259.88	4 450 416.83
18	959 990.23	4 450 370.51	77	960 550.4	4 450 415.7
19	959 989.1	4 450 368.58	78	960 671.83	4 450 414.25
20	959 915.64	4 450 171.82	79	960 669.27	4 450 417.13
21	959 814.14	4 449 899.98	80	960 548.99	4 450 418.28
22	959 984.38	4 450 280.08	81	960 442.11	4 450 416.99
23	959 976.84	4 450 260.2	82	960 440.76	4 450 419.29
24	959 983.54	4 450 257.64	83	960 354.09	4 450 420.1
25	959 981.12	4 450 277.49	84	960 354.2	4 450 428.29
26	965 956.76	4 450 264.85	85	960 351.96	4 450 428.32
27	965 862.05	4 450 278.64	86	960 351.84	4 450 418.07
28	965 861.79	4 450 277.28	87	961 383.28	4 450 435.24
29	965 955.74	4 450 259.27	88	961 383.58	4 450 447.3
30	965 888.7	4 450 304.72	89	961 367.52	4 450 447.45
31	965 867.81	4 450 308.71	90	961 367.34	4 450 437.54
32	965 867.71	4 450 308.19	91	961 256.21	4 450 439.91
33	965 804.6	4 450 320.29	92	960 766.52	4 450 446.89
34	965 309.98	4 450 345.94	93	960 766.51	4 450 445.06
35	965 124.2	4 450 355.57	94	961 148.83	4 450 439.43
36	965 135.02	4 450 352.89	95	961 258.09	4 450 437.94
37	965 804.43	4 450 316.9	96	960 354.47	4 450 451.13
38	965 887.93	4 450 301.06	97	960 354.54	4 450 456.28
39	964 549.72	4 450 369.64	98	960 352.3	4 450 456.07
40	964 548.3	4 450 366.49	99	960 352.26	4 450 452.8
41	964 688.81	4 450 383.29	100	960 313.32	4 450 453.35
42	964 701.57	4 450 366.18	101	960 175.46	4 450 456.32
43	961 366.91	4 450 414.54	102	960 175.44	4 450 453.73
44	961 366.64	4 450 399.45			
45	961 455.71	4 450 397.84			
46	962 284.73	4 450 380.85			
47	962 264.98	4 450 392.13			
48	962 248.07	4 450 382.35			
49	962 153.77	4 450 383.94			
50	962 087.79	4 450 395.33			
51	962 032.38	4 450 395.96			
52	961 863.7	4 450 397.92			
53	961 882.67	4 450 399.11			
54	961 798.63	4 450 400.03			
55	961 705.1	4 450 401.47			
56	961 658.74	4 450 401.42			
57	961 589.84	4 450 403.09			
58	961 511.36	4 450 404.91			
59	961 438.32	4 450 408.47			

Номер	X	Y
60	985 079.13	4 446 137.65
61	985 075.1	4 446 127.29
62	985 081.83	4 446 106.71
63	985 081.31	4 446 106.51
64	985 080.43	4 446 106.33
65	985 079.65	4 446 106.37
66	985 070.26	4 446 107.82
67	985 065.51	4 446 123.08
68	985 074.5	4 446 136.32
69	985 069.42	4 446 140.78

Перечень координат поворотных точек земельного участка
86.04.0000001.3У9

Лист 34 из 134

Номер	X	Y
1	983 586.34	4 443 408.25
2	983 626.02	4 443 401.06
3	983 632.4	4 443 399.54
4	983 632.47	4 443 398.29
5	983 633.29	4 443 383.09
6	983 633.63	4 443 376.85
7	983 633.84	4 443 372.96
8	983 622.61	4 443 375
9	983 620.14	4 443 377.95
10	983 822.14	4 443 389.21
11	983 590.12	4 443 395.02
12	983 587.53	4 443 384.5
13	983 587.49	4 443 384.46
14	983 587.03	4 443 392.98
15	983 622.11	4 443 398.35
16	983 624.38	4 443 397.96
17	983 623.96	4 443 395.76
18	983 821.88	4 443 396.19
19	983 585.85	4 443 418.13
20	983 594.39	4 443 416.6
21	983 593.22	4 443 410.98
22	983 586.16	4 443 412.27
23	985 081.21	4 446 134.44
24	985 085.91	4 446 127.17
25	985 106.74	4 446 120.62
26	985 102.39	4 446 114.47
27	985 150.83	4 446 073.28
28	985 150.93	4 446 073.28
29	985 209.29	4 446 023.7
30	985 201.81	4 446 026.06
31	985 195.9	4 446 031.08
32	985 152.9	4 446 044.6
33	985 124.82	4 446 067.3
34	985 093.35	4 446 088.62
35	985 072.01	4 446 102.18
36	985 071.57	4 446 103.59
37	985 079.15	4 446 102.45
38	985 079.6	4 446 102.35
39	985 080.05	4 446 102.19
40	985 080.5	4 446 101.86
41	985 080.95	4 446 101.62
42	985 081.29	4 446 101.3
43	985 081.85	4 446 100.67
44	985 082.09	4 446 100.12
45	985 082.32	4 446 099.44
46	985 082.45	4 446 098.69
47	985 082.46	4 446 097.34
48	985 083.55	4 446 105.48
49	985 085.22	4 446 105.97
50	985 084.11	4 446 109.32
51	985 084.17	4 446 109.72
52	985 084.11	4 446 109.33
53	985 078.59	4 446 128.1
54	985 140.9	4 446 062.88
55	985 142.77	4 446 061.46
56	985 141.38	4 446 059.81
57	985 139.55	4 446 061.19
58	985 070.5	4 446 142.21
59	985 077.8	4 446 139.78

Перечень координат поворотных точек земельного участка

Номер	X	Y	Номер	X	Y
1	956 128.11	4 436 223.92	61	954 870.45	4 434 712.41
2	956 125.44	4 436 223.03	62	954 865.55	4 434 715.44
3	956 126.93	4 436 216.75	63	954 864.32	4 434 710.81
4	956 132.58	4 436 196.26	64	954 871.65	4 434 706.14
5	956 142.15	4 436 198.08	65	954 871.87	4 434 700.24
6	956 143.04	4 436 192.13	66	954 872.94	4 434 698.52
7	956 141.62	4 436 182.16	67	954 875.71	4 434 696.82
8	956 147.58	4 436 181.4	68	954 877.32	4 434 695.88
9	956 147.8	4 436 182.39	69	954 885.53	4 434 690.86
10	956 145.12	4 436 194.55	70	954 894.64	4 434 685.3
11	956 138.47	4 436 219.94	71	954 899.01	4 434 682.48
12	956 138	4 436 221.74	72	954 904.64	4 434 678.85
13	956 128.73	4 436 219.96	73	954 905.92	4 434 682.88
14	956 123.75	4 436 251.92	74	954 900.22	4 434 687.09
15	956 119.42	4 436 251.18	75	954 900.04	4 434 693.96
16	956 119.6	4 436 249.95			
17	956 120	4 436 250.06			
18	956 120.24	4 436 249.08			
19	956 119.87	4 436 248.97			
20	956 120.41	4 436 245.79			
21	956 121.15	4 436 241.58			
22	956 122.75	4 436 233.86			
23	956 123.47	4 436 230.48			
24	956 123.41	4 436 230.51			
25	956 123.43	4 436 230.41			
26	956 124.27	4 436 226.76			
27	956 127.5	4 436 227.85			
28	956 454.73	4 436 568.43			
29	956 448.1	4 436 565.84			
30	956 431.31	4 436 559.59			
31	956 428.13	4 436 558.46			
32	956 424.87	4 436 542.91			
33	956 425.27	4 436 543.05			
34	956 433.41	4 436 546			
35	956 449.76	4 436 551.67			
36	956 451.33	4 436 552.24			
37	957 327.91	4 437 149.45			
38	957 313.92	4 437 140.24			
39	957 314.12	4 437 136.07			
40	957 314.45	4 437 130.4			
41	957 314.73	4 437 125.4			
42	957 326.69	4 437 134.31			
43	957 326.43	4 437 139.42			
44	957 319.27	4 437 161.74			
45	957 313.08	4 437 157.7			
46	957 313.79	4 437 142.89			
47	957 327.77	4 437 152.1			
48	957 327.46	4 437 158.11			
49	954 290.26	4 430 205.4			
50	954 278.43	4 430 205.44			
51	954 280.49	4 430 155.94			
52	954 291.18	4 430 154.64			
53	954 284.18	4 430 154.27			
54	954 299.49	4 430 153.62			
55	954 304.55	4 430 153			
56	954 306.7	4 430 152.74			
57	954 305.48	4 430 205.25			
58	954 302.9	4 430 205.27			
59	954 293.25	4 430 205.38			
60	954 886.55	4 434 702.36			
61	954 870.45	4 434 712.41			

Перечень координат поворотных точек земельного участка №6:04:000001:3V12

Номер	X	Y
1	983 622.11	4 443 398.35
2	983 624.36	4 443 397.96
3	983 623.85	4 443 395.76
4	983 621.69	4 443 396.19
5	985 092.38	4 444 547.4
6	985 092.93	4 444 547.1
7	985 092.86	4 444 545.98
8	985 091.56	4 444 546.04
9	985 356.8	4 445 347.2
10	985 356.11	4 445 346.78
11	985 358.06	4 445 344.52
12	985 356.08	4 445 345.2
13	985 140.9	4 446 082.88
14	985 142.77	4 446 081.48
15	985 141.38	4 446 059.81
16	985 139.55	4 446 061.19
17	985 084.11	4 446 109.32
18	985 085.22	4 446 105.97
19	985 083.55	4 446 105.48
20	985 079.13	4 446 137.65
21	985 081.21	4 446 134.44
22	985 078.58	4 446 126.1
23	985 084.11	4 446 109.33
24	985 084.07	4 446 109.07
25	985 083.75	4 446 108.43
26	985 083.41	4 446 107.83
27	985 082.98	4 446 107.38
28	985 082.32	4 446 106.89
29	985 081.83	4 446 106.71
30	985 075.1	4 446 127.28

Перечень координат поворотных точек земельного участка №6:04:000001:3V13

Номер	X	Y
1	957 313.91	4 437 140.24
2	957 327.91	4 437 149.45
3	957 327.77	4 437 152.08
4	957 313.78	4 437 142.87

Перечень координат поворотных точек земельного участка №6:04:000001:11250:3V1

Номер	X	Y
1	963 837.44	4 450 361.11
2	963 834.26	4 450 385.06
3	963 721.3	4 450 389.37
4	963 640.07	4 450 390.9
5	963 489.63	4 450 373.56
6	963 513.27	4 450 373.1
7	963 513.27	4 450 373.3
8	963 513.34	4 450 373.3
9	963 513.28	4 450 369.28
10	963 722.37	4 450 365.27
11	963 586.34	4 450 381
12	963 586.24	4 450 378.86
13	963 588.55	4 450 378.79
14	963 588.87	4 450 380.93
15	963 771.92	4 450 376.5
16	963 771.82	4 450 374.36
17	963 774.12	4 450 374.29
18	963 774.24	4 450 376.45
19	963 679.05	4 450 379.27
20	963 678.95	4 450 377.12
21	963 681.28	4 450 377.04
22	963 681.38	4 450 379.2
23	962 841.46	4 450 384.83
24	962 854.83	4 450 405.65
25	962 259.88	4 450 416.83
26	962 260.14	4 450 428.82
27	961 383.58	4 450 447.3
28	961 383.28	4 450 435.24
29	961 383.21	4 450 432.31
30	960 766.48	4 450 441.28
31	960 788.51	4 450 445.06
32	960 766.52	4 450 448.89
33	960 758.42	4 450 447
34	960 758.47	4 450 451.08
35	960 750.74	4 450 451.46
36	960 771.23	4 450 423.86
37	960 929.01	4 450 421.95
38	961 366.93	4 450 415.45
39	961 366.91	4 450 414.54
40	961 382.89	4 450 414.31
41	961 382.8	4 450 410.03
42	961 395.06	4 450 409.78
43	961 438.32	4 450 408.47
44	961 511.36	4 450 404.91
45	961 589.84	4 450 403.09
46	961 658.74	4 450 401.42
47	961 705.1	4 450 401.47
48	961 798.63	4 450 400.03
49	961 882.67	4 450 399.11
50	961 963.7	4 450 397.82
51	962 032.38	4 450 395.86
52	962 087.79	4 450 395.33
53	962 153.77	4 450 393.94
54	962 248.07	4 450 392.35
55	962 264.98	4 450 392.13
56	962 265.07	4 450 396.48
57	962 736.83	4 450 387.72
58	962 736.85	4 450 383.79
59	962 835.29	4 450 381.79

Номер	X	Y	Номер	X	Y	Номер	X	Y
60	960 797.08	4 450 432.54	120	962 118.76	4 450 406.75	180	960 177.08	4 450 439.99
61	960 794.76	4 450 432.41	121	962 118.66	4 450 406.61	181	960 177.16	4 450 437.86
62	960 794.85	4 450 430.26	122	962 120.97	4 450 406.53	182	960 179.48	4 450 437.99
63	960 797.14	4 450 430.38	123	962 121.08	4 450 406.69	183	960 353.55	4 450 437.69
64	962 750.69	4 450 396.76	124	961 501.19	4 450 421.63	184	960 353.64	4 450 435.74
65	962 750.6	4 450 394.61	125	961 501.1	4 450 419.48	185	960 355.95	4 450 435.87
66	962 752.9	4 450 394.54	126	961 503.4	4 450 419.41	186	960 355.88	4 450 438.04
67	962 753.03	4 450 396.7	127	961 503.52	4 450 421.56	187	960 267.83	4 450 439.08
68	960 885.69	4 450 431.51	128	962 030.45	4 450 410.48	188	960 265.32	4 450 438.94
69	960 883.36	4 450 431.36	129	962 030.35	4 450 408.33	189	960 265.41	4 450 436.8
70	960 883.45	4 450 429.21	130	962 032.64	4 450 408.26	190	960 267.7	4 450 436.94
71	960 885.76	4 450 429.35	131	962 032.76	4 450 410.42	191	959 777.18	4 449 750.5
72	962 657.47	4 450 396.43	132	961 589.2	4 450 419.78	192	959 786.78	4 449 773.95
73	962 659.77	4 450 396.36	133	961 589.11	4 450 417.63	193	959 798.53	4 449 802.21
74	962 659.89	4 450 398.61	134	961 591.41	4 450 417.55	194	959 777.26	4 449 813.68
75	962 657.57	4 450 398.58	135	961 591.53	4 450 419.7	195	959 774.36	4 449 817.22
76	960 974.29	4 450 430.52	136	961 942.21	4 450 412.42	196	959 761.35	4 449 789.71
77	960 971.96	4 450 430.37	137	961 942.11	4 450 410.27	197	959 754.06	4 449 793.15
78	960 972.06	4 450 428.23	138	961 944.42	4 450 410.21	198	959 747.81	4 449 779.9
79	960 974.36	4 450 428.35	139	961 944.54	4 450 412.36	199	959 808.14	4 449 821.29
80	962 584.55	4 450 400.09	140	961 677.53	4 450 417.93	200	959 815.39	4 449 837.36
81	962 584.46	4 450 397.94	141	961 677.44	4 450 415.8	201	959 838.69	4 449 888.34
82	962 586.75	4 450 397.87	142	961 679.74	4 450 415.73	202	959 835.31	4 449 889.9
83	962 586.87	4 450 400.02	143	961 679.86	4 450 417.89	203	959 976.22	4 450 260.44
84	961 061.95	4 450 429.38	144	961 853.98	4 450 414.36	204	959 976.84	4 450 260.2
85	961 059.64	4 450 429.24	145	961 853.89	4 450 412.22	205	959 984.38	4 450 280.08
86	961 059.73	4 450 427.1	146	961 856.16	4 450 412.15	206	959 991.12	4 450 277.49
87	961 062.02	4 450 427.23	147	961 856.3	4 450 414.31	207	960 018.95	4 450 352.93
88	962 472.57	4 450 401.84	148	961 765.65	4 450 416.1	208	960 038.05	4 450 368.42
89	962 472.48	4 450 399.71	149	961 765.56	4 450 413.96	209	960 046.9	4 450 381.04
90	962 474.77	4 450 399.64	150	961 767.86	4 450 413.88	210	960 057.8	4 450 389.93
91	962 474.89	4 450 401.8	151	961 767.99	4 450 416.04	211	960 045.78	4 450 422.18
92	961 150.24	4 450 428.48	152	960 529.16	4 450 454.16	212	959 991.84	4 450 371.89
93	961 147.92	4 450 428.35	153	960 548.99	4 450 418.26	213	959 960.12	4 450 289.42
94	961 148.01	4 450 426.21	154	960 689.27	4 450 417.13	214	959 967.57	4 450 286.5
95	961 150.31	4 450 426.33	155	960 637.72	4 450 452.84	215	959 960.02	4 450 266.62
96	962 383.4	4 450 403.76	156	960 620.76	4 450 434.66	216	959 818.94	4 449 897.22
97	962 383.3	4 450 401.61	157	960 618.44	4 450 434.52	217	959 816.7	4 449 898.76
98	962 385.61	4 450 401.53	158	960 618.52	4 450 432.38	218	959 814.14	4 449 899.98
99	962 385.73	4 450 403.68	159	960 620.83	4 450 432.51	219	959 788.36	4 449 846.82
100	961 238.54	4 450 427.28	160	960 440.76	4 450 419.29	220	960 048.17	4 450 402.63
101	961 236.22	4 450 427.15	161	960 419.62	4 450 455.49	221	960 046.48	4 450 401.04
102	961 236.31	4 450 424.99	162	960 354.54	4 450 456.28	222	960 047.93	4 450 399.44
103	961 238.61	4 450 425.12	163	960 354.47	4 450 451.13	223	960 049.61	4 450 401.02
104	962 295.09	4 450 405.17	164	960 354.41	4 450 446.29	224	959 623.06	4 449 886.29
105	962 294.99	4 450 403.03	165	960 175.41	4 450 448.32	225	959 825.75	4 449 884.95
106	962 297.3	4 450 402.95	166	960 175.44	4 450 453.73	226	959 828.52	4 449 890.77
107	962 297.42	4 450 405.1	167	960 175.46	4 450 456.32	227	959 829.44	4 449 892.72
108	961 324.63	4 450 425.6	168	960 134.41	4 450 456.71	228	959 832.3	4 449 900.29
109	961 324.42	4 450 423.45	169	960 150.49	4 450 432.29	229	959 829.49	4 449 901.36
110	961 326.73	4 450 423.39	170	960 158.45	4 450 423.25	230	959 826.48	4 449 893.48
111	961 326.85	4 450 425.55	171	960 170.5	4 450 423.08	231	960 001.88	4 450 354.89
112	962 208.89	4 450 406.7	172	960 171.22	4 450 424.19	232	960 004.68	4 450 353.62
113	962 206.8	4 450 404.54	173	960 171.31	4 450 431.11	233	960 007.15	4 450 360.07
114	962 209.1	4 450 404.48	174	960 171.32	4 450 431.11	234	960 007.63	4 450 361.32
115	962 209.22	4 450 406.64	175	960 171.32	4 450 431.07	235	960 008.45	4 450 362.08
116	961 412.85	4 450 423.67	176	960 351.96	4 450 428.32	236	960 013.57	4 450 368.8
117	961 412.76	4 450 421.52	177	960 354.2	4 450 428.29	237	960 011.52	4 450 368.98
118	961 415.06	4 450 421.45	178	960 354.09	4 450 420.1	238	960 005.58	4 450 363.41
119	961 415.19	4 450 423.61	179	960 179.39	4 450 440.14	239	960 004.96	4 450 362.83
						240	960 004.35	4 450 361.21

Перечень координат поворотных точек
земельного участка
86:04:0000001:112250:3У1

Номер	X	Y
240	960 004.35	4 450 361.21
241	959 859.26	4 449 978.49
242	959 858.43	4 449 976.32
243	959 860.42	4 449 975.51
244	959 861.25	4 449 977.65
245	959 987.16	4 450 315.02
246	959 986.33	4 450 312.85
247	959 988.32	4 450 312.04
248	959 986.15	4 450 314.18
249	959 891.31	4 450 062.73
250	959 890.48	4 450 060.56
251	959 892.47	4 450 059.76
252	959 893.3	4 450 061.91
253	959 954.38	4 450 226.75
254	959 956.37	4 450 227.94
255	959 957.2	4 450 230.1
256	959 955.21	4 450 230.92
257	959 923.17	4 450 146.72
258	959 922.32	4 450 144.55
259	959 924.33	4 450 143.74
260	959 925.16	4 450 145.69

Перечень координат поворотных точек
земельного участка 86:04:0000001:112249:3У1

Номер	X	Y
1	960 354.41	4 450 446.29
2	960 354.47	4 450 451.13
3	960 175.44	4 450 453.73
4	960 175.41	4 450 448.32
5	959 819.94	4 449 897.22
6	959 967.57	4 450 286.5
7	959 960.12	4 450 289.42
8	959 816.7	4 449 898.76
9	961 383.21	4 450 432.31
10	961 383.28	4 450 435.24
11	961 258.09	4 450 437.94
12	961 148.63	4 450 439.43
13	960 766.51	4 450 445.06
14	960 766.48	4 450 441.28

Перечень координат поворотных точек
земельного участка 86:04:0000001:6261:3У1

Номер	X	Y
1	984 802.43	4 443 880.68
2	984 808.11	4 443 887.91
3	984 807.94	4 443 891.9
4	984 806.2	4 443 934.03
5	984 800.55	4 443 929.44
6	984 802.28	4 443 884.44

Перечень координат поворотных точек земельного участка 86:04:0000001:112203:3У1

Номер	X	Y	Номер	X	Y
1	965 956.43	4 450 273.89	61	965 576.25	4 450 317.89
2	965 944.64	4 450 279.28	62	965 576.18	4 450 315.74
3	965 944.09	4 450 276.33	63	965 578.46	4 450 315.67
4	965 941.14	4 450 276.88	64	965 578.58	4 450 317.83
5	965 934.25	4 450 278.15	65	964 628.31	4 450 340.71
6	965 934.73	4 450 281.11	66	964 685.12	4 450 362.45
7	965 941.7	4 450 279.83	67	964 688.81	4 450 363.29
8	965 941.81	4 450 280.38	68	964 548.3	4 450 366.49
9	965 931.24	4 450 284.52	69	964 537.69	4 450 342.6
10	965 888.7	4 450 304.72	70	964 587.37	4 450 354.79
11	965 887.93	4 450 301.06	71	964 587.27	4 450 352.64
12	965 804.43	4 450 316.9	72	964 589.57	4 450 352.57
13	965 135.02	4 450 352.89	73	964 589.69	4 450 354.73

Перечень координат поворотных точек
земельного участка 86:04:0000001:25155:3У1

Номер	X	Y
1	958 471.75	4 436 750.45
2	956 496.77	4 436 755.49
3	956 500.68	4 436 758.28
4	956 502.92	4 436 762.85
5	956 499.02	4 436 762.06
6	956 473.45	4 436 756.91

Перечень координат поворотных точек
земельного участка 86:04:0000001:99338:3У1

Номер	X	Y
1	965 976.35	4 450 291.02
2	965 976.74	4 450 294.52
3	965 962.53	4 450 296.22
4	965 963.05	4 450 298.9
5	965 957.87	4 450 299.59
6	965 957.52	4 450 300.25
7	965 956.65	4 450 299.51
8	965 950.74	4 450 306.45
9	965 948.13	4 450 308.95
10	965 947.88	4 450 305.45
11	965 954.06	4 450 294.13
12	965 961.96	4 450 293.02

Перечень координат поворотных точек
земельного участка 86:04:0000001:25155:3У2

Номер	X	Y
1	980 531.06	4 445 826.26
2	980 530.22	4 445 832.31
3	980 528.59	4 445 832.4
4	980 522.58	4 445 832.46
5	980 522.58	4 445 832.5
6	980 514.44	4 445 832.72
7	980 515.45	4 445 828.66
8	980 524.4	4 445 826.43
9	980 511.5	4 445 826.76
10	980 510.49	4 445 832.82
11	980 505.75	4 445 832.94
12	980 506.6	4 445 826.89
13	980 508.83	4 445 826.83

14	965 206.26	4 450 335.25
15	965 189.98	4 450 325.81
16	965 667.78	4 450 300.19
17	965 737.74	4 450 296.74
18	965 742.07	4 450 298.11
19	965 760.96	4 450 295.13
20	965 761.16	4 450 299.08
21	965 801.99	4 450 296.95
22	965 863.29	4 450 285.14
23	965 863.29	4 450 285.17
24	965 863.3	4 450 285.17
25	965 862.05	4 450 278.64
26	965 956.76	4 450 264.65
27	965 216.77	4 450 336.73
28	965 216.67	4 450 334.59
29	965 218.01	4 450 334.61
30	965 219.09	4 450 338.68
31	965 871.97	4 450 292.74
32	965 871.53	4 450 290.63
33	965 873.78	4 450 290.19
34	965 874.26	4 450 292.29
35	965 308.8	4 450 331.95
36	965 306.71	4 450 329.6
37	965 309	4 450 329.74
38	965 308.12	4 450 331.86
39	965 799.89	4 450 306.15
40	965 799.83	4 450 303.94
41	965 802.62	4 450 303.86
42	965 806.84	4 450 303.25
43	965 806.24	4 450 305.41
44	965 803.03	4 450 306.06
45	965 396.42	4 450 327.05
46	965 396.33	4 450 324.91
47	965 398.62	4 450 324.83
48	965 398.75	4 450 326.99
49	965 756.11	4 450 308.31
50	965 756.02	4 450 306.16
51	965 758.31	4 450 306.1
52	965 758.43	4 450 308.26
53	965 486.44	4 450 322.47
54	965 486.35	4 450 320.33
55	965 488.66	4 450 320.25
56	965 488.78	4 450 322.42
57	965 668.18	4 450 313
58	965 666.09	4 450 310.85
59	965 668.39	4 450 310.76
60	965 668.51	4 450 312.94

Перечень координат поворотных точек земельного участка №6.04.0000001.112251.3У2

Лист 38 из 134

Номер	X	Y	Номер	X	Y	Номер	X	Y
1	959 826.94	4 449 894.67	61	960 048.17	4 450 402.63	121	961 150.24	4 450 428.48
2	959 829.74	4 449 893.52	62	960 049.61	4 450 401.02	122	961 150.31	4 450 426.33
3	959 829.44	4 449 892.72	63	960 047.93	4 450 399.44	123	961 148.01	4 450 426.21
4	959 828.52	4 449 890.77	64	960 046.48	4 450 401.04	124	961 147.92	4 450 428.35
5	959 825.76	4 449 891.95	65	962 383.4	4 450 403.76	125	961 061.95	4 450 429.38
6	959 826.48	4 449 893.46	66	962 385.73	4 450 403.68	126	961 062.02	4 450 427.23
7	959 859.26	4 449 878.49	67	962 385.61	4 450 401.53	127	961 059.73	4 450 427.1
8	959 861.25	4 449 977.65	68	962 383.3	4 450 401.61	128	961 059.64	4 450 429.24
9	959 860.42	4 449 975.51	69	962 295.09	4 450 405.17	129	960 974.29	4 450 430.52
10	959 858.43	4 449 976.32	70	962 297.42	4 450 405.1	130	960 974.36	4 450 428.35
11	959 891.31	4 450 062.73	71	962 297.3	4 450 402.95	131	960 972.06	4 450 428.23
12	959 893.3	4 450 061.91	72	962 294.89	4 450 403.03	132	960 971.96	4 450 430.37
13	959 892.47	4 450 059.76	73	962 206.89	4 450 406.7	133	960 885.69	4 450 431.51
14	959 890.46	4 450 060.56	74	962 209.22	4 450 406.64	134	960 885.76	4 450 429.35
15	959 923.17	4 450 146.72	75	962 209.1	4 450 404.48	135	960 883.45	4 450 429.21
16	959 925.16	4 450 145.89	76	962 206.8	4 450 404.54	136	960 883.36	4 450 431.26
17	959 924.33	4 450 143.74	77	962 118.76	4 450 408.75	137	960 797.08	4 450 432.54
18	959 922.32	4 450 144.55	78	962 121.08	4 450 408.69	138	960 797.14	4 450 430.38
19	959 955.21	4 450 230.92	79	962 120.97	4 450 406.53	139	960 794.65	4 450 430.26
20	959 957.2	4 450 230.1	80	962 118.66	4 450 406.61	140	960 794.76	4 450 432.41
21	959 956.37	4 450 227.94	81	962 030.45	4 450 410.48	141	960 620.76	4 450 434.66
22	959 954.36	4 450 228.75	82	962 032.75	4 450 410.42	142	960 620.83	4 450 432.51
23	959 967.16	4 450 315.02	83	962 032.64	4 450 408.26	143	960 618.52	4 450 432.38
24	959 989.15	4 450 314.18	84	962 030.35	4 450 408.33	144	960 618.44	4 450 434.52
25	959 988.32	4 450 312.04	85	961 942.21	4 450 412.42	145	960 355.68	4 450 438.04
26	959 986.33	4 450 312.85	86	961 944.54	4 450 412.36	146	960 355.95	4 450 435.87
27	960 005.58	4 450 363.41	87	961 944.42	4 450 410.21	147	960 353.64	4 450 435.74
28	960 008.45	4 450 362.06	88	961 942.11	4 450 410.27	148	960 353.55	4 450 437.89
29	960 007.63	4 450 361.32	89	961 853.98	4 450 414.36	149	960 267.63	4 450 439.08
30	960 007.15	4 450 360.07	90	961 856.3	4 450 414.31	150	960 267.7	4 450 436.94
31	960 004.35	4 450 361.21	91	961 856.18	4 450 412.15	151	960 265.41	4 450 436.8
32	960 004.96	4 450 362.83	92	961 853.89	4 450 412.22	152	960 265.32	4 450 436.94
33	963 771.92	4 450 376.5	93	961 765.65	4 450 416.1	153	960 179.39	4 450 440.14
34	963 774.24	4 450 376.45	94	961 787.99	4 450 416.04	154	960 179.46	4 450 437.99
35	963 774.12	4 450 374.29	95	961 767.86	4 450 413.88	155	960 177.16	4 450 437.86
36	963 771.82	4 450 374.36	96	961 765.56	4 450 413.96	156	960 177.08	4 450 439.99
37	963 679.05	4 450 379.27	97	961 677.53	4 450 417.93			
38	963 681.38	4 450 379.2	98	961 679.86	4 450 417.89			
39	963 681.26	4 450 377.04	99	961 679.74	4 450 415.73			
40	963 678.95	4 450 377.12	100	961 677.44	4 450 415.8			
41	963 586.34	4 450 381	101	961 589.2	4 450 419.78			
42	963 588.67	4 450 380.93	102	961 591.53	4 450 419.7			
43	963 588.55	4 450 378.79	103	961 591.41	4 450 417.55			
44	963 586.24	4 450 378.86	104	961 589.11	4 450 417.63			
45	962 750.89	4 450 396.76	105	961 501.19	4 450 421.63			
46	962 753.03	4 450 396.7	106	961 503.52	4 450 421.56			
47	962 752.9	4 450 394.54	107	961 503.4	4 450 416.41			
48	962 750.6	4 450 394.61	108	961 501.1	4 450 419.48			
49	962 657.57	4 450 396.58	109	961 412.85	4 450 423.67			
50	962 659.89	4 450 396.51	110	961 415.19	4 450 423.61			
51	962 659.77	4 450 396.36	111	961 415.06	4 450 421.45			
52	962 657.47	4 450 396.43	112	961 412.76	4 450 421.52			
53	962 584.55	4 450 400.09	113	961 324.53	4 450 425.6			
54	962 566.87	4 450 400.02	114	961 326.85	4 450 425.55			
55	962 566.75	4 450 397.87	115	961 326.73	4 450 423.39			
56	962 564.46	4 450 397.94	116	961 324.42	4 450 423.45			
57	962 472.57	4 450 401.84	117	961 236.54	4 450 427.28			
58	962 474.89	4 450 401.8	118	961 238.61	4 450 425.12			
59	962 474.77	4 450 399.64	119	961 236.31	4 450 424.99			
60	962 472.46	4 450 399.71	120	961 236.22	4 450 427.15			

Перечень координат поворотных точек земельного участка №6.04.0000001.112251.3У1

Номер	X	Y
1	960 004.68	4 450 353.62
2	960 007.15	4 450 360.07
3	960 004.35	4 450 361.21
4	960 001.88	4 450 354.69
5	960 008.45	4 450 362.08
6	960 013.57	4 450 366.8
7	960 011.52	4 450 368.98
8	960 005.58	4 450 363.41
9	959 825.75	4 449 884.95
10	959 828.52	4 449 890.77
11	959 825.76	4 449 891.95
12	959 823.06	4 449 886.29
13	959 832.3	4 449 900.29
14	959 829.48	4 449 901.36
15	959 826.94	4 449 894.67
16	959 829.74	4 449 893.52

Перечень координат поворотных точек
земельного участка 86:04:0000001:112191:3У1

Номер	X	Y
1	965 944.09	4 450 276.33
2	965 944.84	4 450 279.28
3	965 941.81	4 450 280.38
4	965 941.71	4 450 279.82
5	965 941.71	4 450 279.82
6	965 941.7	4 450 279.82
7	965 941.14	4 450 276.88
8	965 871.97	4 450 292.74
9	965 871.53	4 450 290.63
10	965 873.78	4 450 290.19
11	965 874.26	4 450 292.29
12	965 799.89	4 450 306.15
13	965 799.83	4 450 303.84
14	965 802.82	4 450 303.86
15	965 805.84	4 450 303.25
16	965 806.24	4 450 305.41
17	965 803.03	4 450 306.06
18	965 756.11	4 450 308.31
19	965 756.02	4 450 306.16
20	965 758.31	4 450 306.1
21	965 758.43	4 450 308.26
22	965 666.18	4 450 313
23	965 666.09	4 450 310.85
24	965 888.39	4 450 310.76
25	965 888.51	4 450 312.94
26	965 578.25	4 450 317.89
27	965 578.16	4 450 315.74
28	965 578.46	4 450 315.67
29	965 578.58	4 450 317.83
30	965 486.44	4 450 322.47
31	965 486.35	4 450 320.33
32	965 488.66	4 450 320.25
33	965 488.78	4 450 322.42
34	965 396.42	4 450 327.05
35	965 396.33	4 450 324.91
36	965 398.62	4 450 324.83
37	965 398.75	4 450 326.99
38	965 306.8	4 450 331.95
39	965 306.71	4 450 329.8
40	965 309	4 450 329.74
41	965 309.12	4 450 331.88
42	965 218.77	4 450 336.73
43	965 216.67	4 450 334.59
44	965 219.01	4 450 334.51
45	965 219.09	4 450 338.68
46	964 587.37	4 450 354.79
47	964 587.27	4 450 352.84
48	964 589.57	4 450 352.57
49	964 589.69	4 450 354.73

Перечень координат поворотных точек
земельного участка 86:04:0000001:112191:3У1

Номер	X	Y
1	965 941.14	4 450 278.88
2	965 941.7	4 450 279.82
3	965 941.71	4 450 279.82
4	965 941.7	4 450 279.82
6	965 934.73	4 450 281.11
6	965 934.25	4 450 278.15

Перечень координат поворотных точек
земельного участка
86:04:0000001:98340:3У1

Номер	X	Y
1	985 083.55	4 448 105.48
2	985 082.35	4 446 105.13
3	985 081.83	4 446 106.71
4	985 081.31	4 446 106.51
5	985 080.43	4 446 106.33
6	985 079.65	4 446 106.37
7	985 070.26	4 446 107.82
8	985 071.57	4 446 103.89
9	985 079.15	4 446 102.45
10	985 079.6	4 446 102.35
11	985 080.05	4 446 102.19
12	985 080.5	4 446 101.88
13	985 080.95	4 446 101.82
14	985 081.29	4 446 101.3
15	985 081.85	4 446 100.67
16	985 082.09	4 446 100.12
17	985 082.32	4 446 099.44
18	985 082.45	4 446 098.69
19	985 082.46	4 446 087.94

Перечень координат поворотных точек
земельного участка 86:04:0000001:98340:3У1

Номер	X	Y
1	985 083.55	4 448 105.48
2	985 084.07	4 446 109.07
3	985 083.75	4 446 108.43
4	985 083.41	4 446 107.83
5	985 082.88	4 446 107.38
6	985 082.32	4 446 106.89
7	985 081.83	4 446 106.71
8	985 082.35	4 446 105.13

Перечень координат поворотных точек
земельного участка
86:11:0401001:1004:3У2

Лист 39 из 134

Номер	X	Y
1	954 952.89	4 419 683.97
2	954 953.36	4 419 681.82
3	954 951.12	4 419 681.33
4	954 950.65	4 419 683.48
5	954 933.52	4 419 771.87
6	954 933.71	4 419 769.87
7	954 931.41	4 419 769.48
8	954 931.23	4 419 771.85
9	954 925.44	4 419 866.63
10	954 925.99	4 419 860.08
11	954 923.14	4 419 858.11
12	954 922.45	4 419 866.36
13	954 914.54	4 419 988.4
14	954 914.73	4 419 986.21
15	954 912.44	4 419 988.01
16	954 912.25	4 419 988.19
17	954 910.38	4 420 033.01
18	954 910.57	4 420 030.81
19	954 908.27	4 420 030.82
20	954 908.08	4 420 032.79
21	954 896.31	4 420 197.88
22	954 897.74	4 420 180.72
23	954 903.75	4 420 113.64
24	954 905.18	4 420 096.68
25	954 905.02	4 420 095.22
26	954 902.73	4 420 095.03
27	954 902.19	4 420 096.42
28	954 900.78	4 420 113.36
29	954 894.75	4 420 160.48
30	954 893.32	4 420 197.41
31	954 889.26	4 420 273.91
32	954 889.45	4 420 271.72
33	954 887.17	4 420 271.52
34	954 886.96	4 420 273.7
35	954 371.37	4 423 739.44
36	954 371.48	4 423 737.97
37	954 371.53	4 423 737.24
38	954 370.56	4 423 737.14
39	954 370.4	4 423 739.38
40	954 364.52	4 423 827.72
41	954 364.75	4 423 825.52
42	954 362.45	4 423 825.3
43	954 362.23	4 423 827.5
44	954 355.52	4 423 915.88
45	954 355.74	4 423 913.68
46	954 353.45	4 423 913.46
47	954 353.23	4 423 915.65
48	954 346.52	4 424 003.88
49	954 346.74	4 424 001.69
50	954 344.46	4 424 001.46
51	954 344.24	4 424 003.65
52	954 337.53	4 424 081.96
53	954 337.75	4 424 089.76
54	954 335.46	4 424 089.53
55	954 335.24	4 424 091.73
56	954 328.53	4 424 180.04
57	954 328.75	4 424 177.84
58	954 326.47	4 424 177.62
59	954 326.24	4 424 179.81
60	954 260.19	4 424 265.03

Перечень координат поворотных точек
земельного участка 86:11:0401001:1004:3У2

Номер	X	Y
60	954 260.19	4 424 265.03
61	954 260.34	4 424 262.83
62	954 258.04	4 424 262.69
63	954 257.9	4 424 264.87
64	954 319.48	4 424 268.07
65	954 319.63	4 424 265.88
66	954 317.33	4 424 265.74
67	954 317.19	4 424 267.92
68	954 314.12	4 424 355.42
69	954 314.25	4 424 353.24
70	954 311.95	4 424 353.09
71	954 311.82	4 424 355.28
72	954 308.65	4 424 442.78
73	954 308.78	4 424 440.57
74	954 306.46	4 424 440.43
75	954 306.34	4 424 442.63
76	954 303.17	4 424 530.12
77	954 303.31	4 424 527.92
78	954 300.99	4 424 527.77
79	954 300.86	4 424 529.97
80	954 287.69	4 424 617.46
81	954 287.82	4 424 615.27
82	954 295.52	4 424 615.12
83	954 295.39	4 424 617.31
84	954 292.21	4 424 704.81
85	954 292.35	4 424 702.61
86	954 290.05	4 424 702.47
87	954 289.91	4 424 704.66
88	954 286.73	4 424 792.16
89	954 286.88	4 424 789.96
90	954 284.57	4 424 789.82
91	954 284.44	4 424 792.02
92	954 281.26	4 424 879.51
93	954 281.4	4 424 877.31
94	954 279.1	4 424 877.16
95	954 278.96	4 424 879.36
96	954 275.78	4 424 966.85
97	954 275.93	4 424 964.66
98	954 273.63	4 424 964.51
99	954 273.49	4 424 958.7
100	954 270.31	4 425 054.2
101	954 270.45	4 425 052
102	954 268.15	4 425 051.85
103	954 268.02	4 425 054.05
104	954 264.84	4 425 141.54
105	954 264.98	4 425 139.34
106	954 262.88	4 425 139.19
107	954 262.54	4 425 141.39

Перечень координат поворотных точек
земельного участка 86:11:0401001:1005:3У2

Номер	X	Y
1	954 925.44	4 419 866.63
2	954 919.79	4 419 929.5
3	954 916.79	4 419 929.28
4	954 922.45	4 419 866.36

Перечень координат поворотных точек земельного участка 86:11:0902001:571:3У2

Номер	X	Y	Номер	X	Y
1	955 844.23	4 411 633.12	61	956 776.97	4 412 408.1
2	955 846.5	4 411 632.73	62	956 774.84	4 412 407.53
3	955 846.13	4 411 630.56	63	956 774.26	4 412 409.76
4	955 843.88	4 411 630.95	64	956 858.13	4 412 431.76
5	955 858.7	4 411 820.14	65	956 858.71	4 412 429.54
6	955 861.66	4 411 919.63	66	956 858.58	4 412 428.98
7	955 860.02	4 411 910.01	67	956 856	4 412 431.2
8	955 857.07	4 411 910.54	68	956 939.9	4 412 453.21
9	955 927.87	4 412 056.5	69	956 940.49	4 412 450.99
10	955 930.46	4 412 056.28	70	956 939.36	4 412 450.42
11	955 934.41	4 412 053.44	71	956 937.77	4 412 452.65
12	955 934.18	4 412 052.31	72	957 021.57	4 412 474.55
13	955 933.3	4 412 051.4	73	957 022.21	4 412 472.45
14	955 927.48	4 412 055.32	74	957 020	4 412 471.78
15	955 945.38	4 412 112.76	75	957 019.37	4 412 473.9
16	955 947.22	4 412 111.56	76	957 076.86	4 412 489.1
17	955 945.93	4 412 109.65	77	957 077.5	4 412 486.99
18	955 944.1	4 412 110.88	78	957 075.29	4 412 486.33
19	956 023.31	4 412 134.71	79	957 074.66	4 412 488.45
20	956 023.94	4 412 132.5	80	957 134.31	4 412 504.33
21	956 021.83	4 412 131.9	81	957 134.95	4 412 502.22
22	956 021.19	4 412 134.11	82	957 132.74	4 412 501.55
23	956 100.39	4 412 156.6	83	957 132.11	4 412 503.67
24	956 101.03	4 412 154.38	84	957 222.15	4 412 527.25
25	956 098.91	4 412 153.79	85	957 222.74	4 412 525.04
26	956 098.28	4 412 155.99	86	957 220.61	4 412 524.47
27	956 177.48	4 412 178.49	87	957 220.03	4 412 526.7
28	956 178.09	4 412 176.28	88	957 238.46	4 413 114.65
29	956 175.96	4 412 175.67	89	957 240.34	4 413 113.49
30	956 175.35	4 412 177.88	90	957 239.14	4 413 111.53
31	956 254.54	4 412 200.37	91	957 237.26	4 413 112.69
32	956 255.16	4 412 198.16	92	957 163.58	4 413 160.45
33	956 253.05	4 412 197.58	93	957 165.46	4 413 159.31
34	956 252.42	4 412 199.77	94	957 164.25	4 413 157.35
35	956 310.19	4 412 216.19	95	957 162.37	4 413 158.51
36	956 310.63	4 412 213.68	96	957 088.5	4 413 206.36
37	956 308.7	4 412 213.37	97	957 090.33	4 413 205.09
38	956 308.08	4 412 215.58	98	957 089.05	4 413 203.21
39	956 361.38	4 412 230.81	99	957 087.21	4 413 204.43
40	956 362.67	4 412 229.03	100	957 013.96	4 413 251.93
41	956 381.02	4 412 227.88	101	957 015.8	4 413 250.67
42	956 360.72	4 412 227.78	102	957 014.51	4 413 248.79
43	956 359.5	4 412 229.49	103	957 012.67	4 413 250
44	956 412.09	4 412 284.95	104	956 939.87	4 413 296.09
45	956 413.37	4 412 263.04	105	956 940.79	4 413 296.07
46	956 411.54	4 412 261.81	106	956 938.72	4 413 295.12
47	956 410.26	4 412 263.71	107	956 937.78	4 413 297.11
48	956 566.83	4 412 312.36	108	956 902.61	4 413 378.22
49	956 573.56	4 412 311.08	109	956 903.53	4 413 376.22
50	956 572.62	4 412 306.14	110	956 901.45	4 413 375.25
51	956 565.24	4 412 308.01	111	956 900.52	4 413 377.24
52	956 632.65	4 412 348.31	112	956 865.23	4 413 458.66
53	956 633.14	4 412 347.55	113	956 866.17	4 413 456.66
54	956 631.28	4 412 346.38	114	956 864.06	4 413 455.7
55	956 630.84	4 412 347.37	115	956 863.15	4 413 457.69
56	956 694.81	4 412 388.87	116	956 827.87	4 413 539.1
57	956 695.45	4 412 388.76	117	956 828.61	4 413 537.1
58	956 693.24	4 412 388.1	118	956 828.72	4 413 536.14
59	956 692.61	4 412 388.22	119	956 825.79	4 413 536.13
60	956 776.38	4 412 410.32	120	956 791.28	4 413 617.9

Перечень координат поворотных точек земельного участка 86:11:0902001:571:3V2

Лист 41 из 134

Номер	X	Y	Номер	X	Y
121	956 792.22	4 413 615.91	181	955 651.28	4 416 351.15
122	956 790.13	4 413 614.93	182	955 649.09	4 416 350.46
123	956 789.2	4 413 616.93	183	955 648.43	4 416 352.57
124	956 752.85	4 413 700.41			
125	956 753.77	4 413 698.4			
126	956 751.7	4 413 697.44			
127	956 750.76	4 413 699.43			
128	956 705.88	4 413 701.11			
129	956 706.8	4 413 699.09			
130	956 704.73	4 413 698.14			
131	956 703.79	4 413 700.12			
132	956 715.79	4 413 780.46			
133	956 716.72	4 413 778.45			
134	956 714.63	4 413 777.49			
135	956 713.71	4 413 779.48			
136	956 678.43	4 413 880.9			
137	956 679.35	4 413 858.91			
138	956 677.28	4 413 857.93			
139	956 676.34	4 413 859.94			
140	956 641.06	4 413 941.35			
141	956 642	4 413 939.35			
142	956 639.91	4 413 938.39			
143	956 638.98	4 413 940.39			
144	956 117.79	4 415 763.7			
145	956 119.73	4 415 762.64			
146	956 118.02	4 415 760.64			
147	956 118.68	4 415 761.68			
148	955 961.33	4 415 855.88			
149	955 963.58	4 415 853.72			
150	955 966.17	4 415 852.2			
151	955 965.06	4 415 850.3			
152	955 962.29	4 415 851.92			
153	955 959.88	4 415 854.93			
154	955 894.77	4 415 914.08			
155	955 896.43	4 415 912.63			
156	955 894.91	4 415 910.9			
157	955 893.26	4 415 912.35			
158	955 828.02	4 415 972.6			
159	955 829.88	4 415 971.14			
160	955 828.16	4 415 969.41			
161	955 826.51	4 415 970.87			
162	955 764.16	4 416 029			
163	955 785.04	4 416 028.97			
164	955 782.95	4 416 028.15			
165	955 782.02	4 416 028.15			
166	955 731.26	4 416 114.4			
167	955 732.06	4 416 112.35			
168	955 729.92	4 416 111.51			
169	955 729.12	4 416 113.57			
170	955 698.7	4 416 198.97			
171	955 699.62	4 416 198.04			
172	955 700.72	4 416 193.19			
173	955 698.67	4 416 192.39			
174	955 697.54	4 416 185.32			
175	955 696.6	4 416 198.31			
176	955 672.97	4 416 281.66			
177	955 673.63	4 416 279.56			
178	955 671.42	4 416 278.88			
179	955 670.78	4 416 280.98			
180	955 650.63	4 416 353.25			
181	955 651.28	4 416 351.15			

Перечень координат поворотных точек земельного участка 86:11:0901001:160:3V2

Номер	X	Y	Номер	X	Y
1	955 719.52	4 409 750.24	56	955 641.83	4 410 828.83
2	955 719.62	4 409 748.04	57	955 639.72	4 410 825.55
3	955 717.32	4 409 747.94	58	955 638.49	4 410 827.37
4	955 717.22	4 409 750.13	59	955 610.18	4 410 674.74
5	955 713.51	4 409 835.62	60	955 610.44	4 410 672.54
6	955 715.76	4 409 835.23	61	955 608.15	4 410 672.28
7	955 715.39	4 409 833.04	62	955 607.91	4 410 674.47
8	955 713.12	4 409 833.43	63	955 602.94	4 410 747.84
9	955 726.8	4 409 914.16	64	955 603.15	4 410 745.45
10	955 729.05	4 409 913.77	65	955 600.87	4 410 745.22
11	955 728.67	4 409 911.6	66	955 600.65	4 410 747.41
12	955 726.41	4 409 912.02	67	955 593.16	4 410 823.04
13	955 740.26	4 409 993.37	68	955 596.15	4 410 823.02
14	955 742.51	4 409 992.96	69	955 596.14	4 410 819.58
15	955 742.12	4 409 990.8	70	955 596.47	4 410 816.16
16	955 739.86	4 409 991.19	71	955 593.49	4 410 815.86
17	955 818.73	4 410 058.68	72	955 593.13	4 410 819.53
18	955 819.17	4 410 056.51	73	955 593.86	4 410 907.4
19	955 816.91	4 410 056.05	74	955 596.66	4 410 907.39
20	955 816.49	4 410 058.22	75	955 596.6	4 410 900.59
21	955 755.71	4 410 072.04	76	955 593.6	4 410 900.58
22	955 756.15	4 410 070.77	77	955 596.86	4 410 889.41
23	955 753.89	4 410 070.31	78	955 596.85	4 410 987.21
24	955 753.47	4 410 072.49	79	955 594.56	4 410 887.22
25	955 817.9	4 410 092.76	80	955 594.57	4 410 889.41
26	955 818.28	4 410 090.58	81	955 597.37	4 411 073.81
27	955 816.08	4 410 090.12	82	955 597.37	4 411 071.61
28	955 815.66	4 410 092.3	83	955 595.06	4 411 071.61
29	955 808.39	4 410 170.81	84	955 595.06	4 411 073.61
30	955 808.68	4 410 168.44	85	955 595.59	4 411 158.22
31	955 806.39	4 410 168.15	86	955 597.89	4 411 158.2
32	955 806.12	4 410 170.32	87	955 597.88	4 411 156.03
33	955 799.85	4 410 233.29	88	955 597.86	4 411 156.02
34	955 800.78	4 410 230.28	89	955 595.59	4 411 156.02
35	955 801.18	4 410 227.14	90	955 596.32	4 411 220.23
36	955 798.99	4 410 226.86	91	955 598.09	4 411 220.21
37	955 798.6	4 410 229.9	92	955 598.06	4 411 217.89
38	955 787.94	4 410 232.87	93	955 596.32	4 411 218.02
39	955 782.85	4 410 310.71	94	955 595.95	4 411 218.47
40	955 783.34	4 410 308.56	95	955 595.96	4 411 219.46
41	955 781.09	4 410 308.06	96	955 619.47	4 411 247.66
42	955 780.62	4 410 310.21	97	955 621.87	4 411 237.47
43	955 785.09	4 410 390.04	98	955 614.66	4 411 236.2
44	955 785.57	4 410 387.91	99	955 615.13	4 411 237.33
45	955 783.32	4 410 387.39	100	955 616.6	4 411 280.03
46	955 782.84	4 410 389.55	101	955 616.83	4 411 257.83
47	955 746.82	4 410 469.57	102	955 614.53	4 411 257.6
48	955 747.73	4 410 467.54	103	955 614.33	4 411 259.79
49	955 745.62	4 410 466.6	104	955 597.75	4 411 310.65
50	955 744.74	4 410 468.63	105	955 597.98	4 411 308.45
51	955 678.12	4 410 572.29	106	955 595.77	4 411 308.24
52	955 679.34	4 410 570.47	107	955 595.65	4 411 308.56
53	955 677.42	4 410 569.19	108	955 595.48	4 411 310.42
54	955 676.21	4 410 571.02	109	955 598.55	4 411 388.59
55	955 640.41	4 410 828.85	110	955 598.53	4 411 385.71

Перечень координат поворотных точек
земельного участка 86:11:0901001:160-3У2

Номер	X	Y
111	955 597.29	4 411 385.71
112	955 597.52	4 411 386.14
113	955 611.75	4 411 452.14
114	955 613.99	4 411 451.6
115	955 613.47	4 411 449.45
116	955 611.23	4 411 450
117	955 624.68	4 411 504.88
118	955 626.84	4 411 504.12
119	955 626.11	4 411 502.03
120	955 623.94	4 411 502.81
121	955 676.92	4 411 567.27
122	955 678.69	4 411 565.8
123	955 677.28	4 411 564.12
124	955 675.51	4 411 565.59

Перечень координат поворотных точек
земельного участка 86:11:0903001:413-3У2

Номер	X	Y
60	954 970.3	4 419 341.38
61	954 968	4 419 341.39
62	954 968	4 419 343.57
63	954 970.33	4 419 432.27
64	954 970.32	4 419 430.08
65	954 968.03	4 419 430.08
66	954 968.03	4 419 432.27
67	954 968.06	4 419 520.97
68	954 970.35	4 419 520.96
69	954 970.35	4 419 519.2
70	954 968.05	4 419 518.98
71	954 970.1	4 419 607.48
72	954 970.27	4 419 605.3
73	954 967.99	4 419 605.11
74	954 967.81	4 419 607.29

Перечень координат поворотных точек
земельного участка 86:11:0901001:308-3У2

Номер	X	Y
1	955 727.78	4 409 581.33
2	955 725.51	4 409 581.27
3	955 725.56	4 409 578.06
4	955 727.85	4 409 579.11
5	955 701.19	4 409 511.93
6	955 710.53	4 409 527.37
7	955 707.97	4 409 528.92
8	955 698.3	4 409 513.66
9	955 700.49	4 409 512.35
10	955 690.88	4 409 518.1
11	955 698.72	4 409 531.24
12	955 698.18	4 409 532.79
13	955 688.2	4 409 519.69

Номер	X	Y
60	955 629.23	4 416 421.27
61	955 627.08	4 416 420.43
62	955 626.75	4 416 421.5

Перечень координат поворотных точек
земельного участка 86:11:0902001:573-3У2

Номер	X	Y
1	955 861.06	4 411 932.12
2	955 863.11	4 411 930.48
3	955 861.86	4 411 919.63
4	955 858.7	4 411 920.14
5	955 864.32	4 411 950.93
6	955 866.37	4 411 949.29
7	955 864.29	4 411 937.28
8	955 862.23	4 411 938.83
9	955 928.67	4 412 058.67
10	955 930.48	4 412 056.28
11	955 927.87	4 412 056.6
12	956 530.41	4 412 342.69
13	956 532	4 412 342.03
14	956 519.08	4 412 333.47
15	956 518.51	4 412 333.6
16	956 518.33	4 412 333.83
17	957 009.49	4 412 471.78
18	957 010.25	4 412 468.88
19	957 003.43	4 412 467.08
20	957 002.67	4 412 469.98
21	957 124.93	4 412 501.77
22	957 125.48	4 412 499.63
23	957 123.17	4 412 498.95
24	957 122.82	4 412 501.07
25	956 876.68	4 413 678.83
26	956 878.06	4 413 675.1
27	956 874.34	4 413 669.24
28	956 872.21	4 413 674.67
29	956 867.64	4 415 793.07
30	956 869.58	4 415 792.01
31	956 868.47	4 415 790.01
32	956 866.53	4 415 791.05
33	956 853.68	4 415 801.6
34	956 859.75	4 415 798.11
35	956 856.25	4 415 795.52
36	956 852.2	4 415 799
37	955 961.2	4 415 856.15
38	955 963.8	4 415 854
39	955 966.74	4 415 852.35
40	955 965.26	4 415 849.74
41	955 962.19	4 415 851.54
42	955 969.3	4 415 853.84
43	955 961.33	4 415 855.68
44	955 963.58	4 415 853.72
45	955 966.17	4 415 852.2
46	955 965.06	4 415 850.3
47	955 962.29	4 415 851.82
48	955 959.88	4 415 854.03
49	955 898.95	4 416 199.51
50	955 701.33	4 416 193.03
51	955 698.55	4 416 191.89
52	955 696.09	4 416 188.58
53	955 698.7	4 416 198.97
54	955 699.62	4 416 196.04
55	955 700.72	4 416 193.19
56	955 698.67	4 416 192.39
57	955 697.54	4 416 195.32
58	955 696.6	4 416 198.31
59	955 628.95	4 416 422.17
60	955 629.23	4 416 421.27

Перечень координат поворотных точек
земельного участка 86:11:0903001:413-3У2

Номер	X	Y
1	955 322.87	4 417 252.62
2	955 325.27	4 417 252.57
3	955 325.19	4 417 250.36
4	955 322.91	4 417 250.43
5	955 159.32	4 417 977.48
6	955 159.95	4 417 974.47
7	955 160.74	4 417 971.51
8	955 158.61	4 417 970.96
9	955 157.61	4 417 973.97
10	955 157.17	4 417 977.03
11	955 141.65	4 418 062.39
12	955 142.1	4 418 060.24
13	955 138.65	4 418 058.78
14	955 139.4	4 418 061.92
15	955 048.45	4 418 509.92
16	955 048.56	4 418 507.74
17	955 046.28	4 418 507.57
18	955 046.14	4 418 508.78
19	955 055.76	4 418 581.02
20	955 058.73	4 418 580.62
21	955 057.34	4 418 570.45
22	955 054.38	4 418 570.81
23	955 068.33	4 418 671.93
24	955 071.31	4 418 671.55
25	955 070.31	4 418 664.28
26	955 067.34	4 418 664.64
27	955 041.19	4 418 811.79
28	955 042.49	4 418 810.02
29	955 040.63	4 418 808.67
30	955 039.33	4 418 810.44
31	955 001.2	4 418 866.97
32	955 001.9	4 418 864.9
33	954 999.73	4 418 864.14
34	954 999.02	4 418 866.22
35	954 991.53	4 418 932.83
36	954 991.85	4 418 930.66
37	954 989.58	4 418 930.33
38	954 989.25	4 418 932.5
39	954 981.68	4 419 013.8
40	954 983.66	4 419 013.75
41	954 983.78	4 419 012.44
42	954 981.87	4 419 012.35
43	954 979.18	4 419 016.18
44	954 979.43	4 419 013.99
45	954 977.15	4 419 013.71
46	954 976.89	4 419 015.89
47	954 970.11	4 419 077.33
48	954 970.36	4 419 075.16
49	954 968.06	4 419 074.88
50	954 987.82	4 419 077.06
51	954 970.25	4 419 166.16
52	954 970.25	4 419 163.97
53	954 967.95	4 419 163.98
54	954 967.95	4 419 166.16
55	954 970.27	4 419 256.87
56	954 970.27	4 419 254.67
57	954 967.98	4 419 254.87
58	954 967.98	4 419 256.87
59	954 970.3	4 419 343.57

Перечень координат поворотных точек
земельного участка 86:11:0901001:161:3У2

Номер	X	Y
1	955 742.51	4 409 992.86
2	955 742.12	4 409 990.8
3	955 742.13	4 409 990.8
4	955 742.52	4 409 992.96
5	955 833.9	4 410 042.54
6	955 835.76	4 410 047.24
7	955 829.48	4 410 050.06
8	955 828.42	4 410 048.03
9	955 830.37	4 410 048.98
10	955 831.91	4 410 042.65
11	955 801.48	4 410 228.03
12	955 800.78	4 410 230.28
13	955 801.18	4 410 227.14
14	955 798.99	4 410 226.86
15	955 798.6	4 410 229.9
16	955 797.94	4 410 232.67
17	955 799.86	4 410 233.29
18	955 799.73	4 410 233.68
19	955 797.44	4 410 233.15
20	955 798.22	4 410 229.78
21	955 798.65	4 410 226.38
22	955 801.84	4 410 226.76
23	955 896.95	4 411 218.47
24	955 595.96	4 411 219.48
25	955 596.32	4 411 220.23
26	955 595.81	4 411 220.23
27	955 595.77	4 411 218.69
28	955 599.53	4 411 390.9
29	955 598.55	4 411 388.59
30	955 596.53	4 411 385.71
31	955 597.29	4 411 385.71
32	955 597.07	4 411 385.31
33	955 598.96	4 411 385.3
34	955 598.97	4 411 388.63
35	955 676.55	4 411 571.33
36	955 671.44	4 411 585.14
37	955 677.8	4 411 580.04
38	955 682.73	4 411 566.25
39	955 676.92	4 411 587.27
40	955 675.51	4 411 585.59
41	955 677.28	4 411 564.12
42	955 678.69	4 411 585.8

Перечень координат поворотных точек
земельного участка 86:11:0000000:69432:3У2

Номер	X	Y
1	955 866.14	4 411 961.42
2	955 868.4	4 411 961.01
3	955 866.37	4 411 949.29
4	955 864.32	4 411 950.93
5	955 871.06	4 411 991.13
6	955 873.32	4 411 990.73
7	955 872.94	4 411 988.55
8	955 870.88	4 411 988.97
9	954 927.98	4 419 835.59
10	954 928.17	4 419 833.4
11	954 925.88	4 419 833.2
12	954 925.69	4 419 835.38

Перечень координат поворотных точек
земельного участка 86:11:1001001:2580:3У2

Номер	X	Y
1	955 723.6	4 409 665.77
2	955 721.31	4 409 665.67
3	955 721.41	4 409 683.47
4	955 723.71	4 409 663.58
5	955 888.47	4 409 508.71
6	955 686.09	4 409 508.92
7	955 884.57	4 409 505.98
8	955 885.44	4 409 505.25
9	955 886.42	4 409 504.43
10	955 686.91	4 409 504.24
11	955 697.2	4 409 504.77
12	955 696.8	4 409 505.48
13	955 695.58	4 409 505.79
14	955 887.98	4 409 610.76
15	955 689.76	4 409 513.17
16	955 688.46	4 409 514.13
17	955 690.87	4 409 518.1
18	955 688.2	4 409 519.69
19	955 684.31	4 409 513.47

Перечень координат поворотных точек
земельного участка 86:11:0902001:3У2

Номер	X	Y
1	956 530.41	4 412 342.89
2	956 531.99	4 412 342.03
3	956 537.09	4 412 345.41
4	956 535.95	4 412 347.29
5	956 529.95	4 412 343.32

Перечень координат поворотных точек земельного
участка 86:1001001:2579:3У2

Номер	X	Y
1	955 700.18	4 409 511.9
2	955 700.49	4 409 512.34
3	955 698.3	4 409 513.86
4	955 697.67	4 409 512.68
5	955 695.19	4 409 504.9
6	955 695.44	4 409 505.25
7	955 894.57	4 409 505.98
8	955 894.21	4 409 505.28
9	955 696.09	4 409 508.92
10	955 696.47	4 409 508.71
11	955 697.16	4 409 510.99

Перечень координат поворотных точек
земельного участка 86:11:1001001:2580:3У1

Номер	X	Y
1	955 694.57	4 409 505.98
2	955 696.09	4 409 508.92
3	955 694.84	4 409 509.65
4	955 683.12	4 409 507.18

Перечень координат поворотных точек земельного
участка 86:11:0401001:1006:3У1

Номер	X	Y
1	954 898.87	4 420 254.32
2	954 933.1	4 419 865
3	954 937.68	4 419 868.17
4	954 906.22	4 420 226.14
5	954 968.45	4 419 658.3
6	954 973.26	4 419 660.76
7	954 970.32	4 419 677.1
8	954 982.8	4 419 684.15
9	954 948.51	4 419 767.85
10	954 940.44	4 419 837.01
11	954 935.84	4 419 833.91
12	954 941.34	4 419 771.32
13	954 947.28	4 419 742.45
14	954 950.28	4 419 742.74
15	954 268.02	4 425 216.13
16	954 327.48	4 424 267.61
17	954 356.53	4 423 997.69
18	954 348.37	4 424 114.22
19	954 332.68	4 424 264.07
20	954 273.08	4 425 213.31

Перечень координат поворотных точек
земельного участка 86:11:0902001:322:3У1

Номер	X	Y
1	955 687.59	4 416 288.24
2	955 686.97	4 416 290.38
3	955 681.58	4 416 291.22
4	955 674.89	4 416 292.3
5	955 657.99	4 416 285.02
6	955 658.89	4 416 292.87
7	955 675.55	4 416 290.17
8	955 682.24	4 416 289.1

Перечень координат поворотных точек
земельного участка 86:11:0902001:326:3У1

Номер	X	Y
1	956 247.16	4 412 179.79
2	956 249.32	4 412 180.41
3	956 246.23	4 412 183.87
4	956 227.09	4 412 203.86
5	956 225.54	4 412 205.5
6	956 223.37	4 412 204.88
7	956 224.92	4 412 203.24
8	956 244.06	4 412 183.05

Перечень координат поворотных точек
земельного участка 86:11:0902001:319:3У1

Номер	X	Y
1	955 844.84	4 416 368.5
2	955 850.65	4 416 370.61
3	955 867.01	4 416 376.52
4	955 867.83	4 416 376.88
5	955 670.6	4 416 380.26
6	955 866.27	4 416 378.39
7	955 850.05	4 416 372.52
8	955 844.12	4 416 370.37
9	955 834.68	4 416 366.5
10	955 835.25	4 416 364.57

Перечень координат поворотных точек земельного участка 86:11:0903001:413:3У1

Номер	X	Y	Номер	X	Y
1	955 293.73	4 417 243.13	60	954 999.02	4 418 866.22
2	955 295.42	4 417 244.63	61	954 999.73	4 418 884.14
3	955 297.44	4 417 246.46	62	955 001.9	4 418 864.9
4	955 298.82	4 417 247.18	63	954 981.87	4 419 012.35
5	955 298.75	4 417 248.9	64	954 981.66	4 419 013.8
6	955 301.32	4 417 249.02	65	954 983.66	4 419 013.75
7	955 301.17	4 417 252.01	66	954 983.59	4 419 014.57
8	955 297.54	4 417 251.83	67	954 986.28	4 419 014.77
9	955 294.84	4 417 249.45	68	954 985.6	4 419 019.38
10	955 294.67	4 417 249.66	69	954 976.29	4 419 018.9
11	955 293.76	4 417 249.01	70	954 976.65	4 419 012.1
12	955 293.25	4 417 243.67	71	954 979.18	4 419 016.18
13	955 326.79	4 417 248.93	72	954 976.89	4 419 015.89
14	955 325.71	4 417 252.6	73	954 977.15	4 419 013.71
15	955 324.46	4 417 253.07	74	954 979.43	4 419 013.99
16	955 315.67	4 417 252.66	75	954 970.53	4 419 084.87
17	955 315.61	4 417 249.66	76	954 967.53	4 419 084.88
18	955 323.99	4 417 250.03	77	954 967.57	4 419 076.37
19	955 322.97	4 417 252.62	78	954 968.78	4 419 067.74
20	955 322.91	4 417 250.43	79	954 971.74	4 419 068.16
21	955 325.19	4 417 250.36	80	954 970.57	4 419 076.49
22	955 325.27	4 417 252.57	81	954 970.11	4 419 077.33
23	955 323.56	4 418 149.09	82	954 967.82	4 419 077.06
24	955 121.31	4 418 148.62	83	954 968.08	4 419 074.88
25	955 121.76	4 418 148.47	84	954 970.36	4 419 075.16
26	955 124.01	4 418 146.95	85	954 965.86	4 419 614.59
27	955 086.48	4 418 326.78	86	954 965.9	4 419 613.87
28	955 084.23	4 418 326.31	87	954 967.71	4 419 605.66
29	955 084.69	4 418 324.15	88	954 967.75	4 419 597.21
30	955 086.93	4 418 324.63	89	954 970.73	4 419 597.35
31	955 067.97	4 418 415.42	90	954 970.67	4 419 606.21
32	955 065.73	4 418 414.94	91	954 970.1	4 419 607.48
33	955 066.18	4 418 412.79	92	954 967.81	4 419 607.29
34	955 068.43	4 418 413.26	93	954 967.99	4 419 605.11
35	955 047.05	4 418 517.2	94	954 970.27	4 419 605.3
36	955 045.84	4 418 508.52			
37	955 047.64	4 418 499.93			
38	955 050.58	4 418 500.55			
39	955 048.89	4 418 508.61			
40	955 050.02	4 418 516.78			
41	955 048.45	4 418 509.92			
42	955 046.14	4 418 509.78			
43	955 046.28	4 418 507.57			
44	955 048.56	4 418 507.74			
45	955 056.43	4 418 563.81			
46	955 057.34	4 418 570.45			
47	955 054.36	4 418 570.81			
48	955 053.46	4 418 584.23			
49	955 069	4 418 654.73			
50	955 070.31	4 418 664.26			
51	955 067.34	4 418 684.64			
52	955 086.04	4 418 655.15			
53	955 000.62	4 418 874.15			
54	954 997.65	4 418 873.73			
55	954 998.93	4 418 865.11			
56	955 004.27	4 418 857.76			
57	955 006.65	4 418 859.56			
58	955 001.78	4 418 868.04			
59	955 001.2	4 418 868.97			
60	954 999.02	4 418 866.22			

Перечень координат поворотных точек земельного участка 86:11:0903001:37:3У1

Номер	X	Y
1	955 121.78	4 418 285.73
2	955 122.58	4 418 283.91
3	955 119.48	4 418 282.46
4	955 111.2	4 418 278.62
5	955 109.8	4 418 277.96
6	955 103.33	4 418 274.84
7	955 090.7	4 418 268.6
8	955 089.36	4 418 268.16
9	955 088.94	4 418 270.18
10	955 090.29	4 418 270.82
11	955 103.32	4 418 277.07
12	955 103.65	4 418 277.22
13	955 110.12	4 418 280.31
14	955 118.21	4 418 284.07

Перечень координат поворотных точек земельного участка 86:11:0902001:531:3У1

Номер	X	Y
1	955 999.61	4 412 160.38
2	956 002.78	4 412 160.38
3	956 006.17	4 412 161.07
4	956 000.71	4 412 164.25
5	955 990.41	4 412 161.57
6	955 992.27	4 412 161.5
7	955 983.88	4 412 135.47
8	955 982.19	4 412 135
9	955 987.28	4 412 122.7
10	955 990.15	4 412 114.87
11	955 990.35	4 412 154.3
12	955 992.9	4 412 154.49
13	956 000.02	4 412 154.59
14	956 004.72	4 412 154.95
15	956 009.96	4 412 155.85
16	956 013.48	4 412 156.82
17	956 011.22	4 412 156.12
18	956 002.17	4 412 156.21
19	956 000.99	4 412 157.43
20	955 989.15	4 412 156.62
21	955 989.93	4 412 155.9

Перечень координат поворотных точек земельного участка 86:11:0900000:69437:3У1

Номер	X	Y
1	955 705.11	4 410 557.88
2	955 686.69	4 410 542.98
3	955 687.81	4 410 541.3
4	955 708.24	4 410 556.22
5	955 683.53	4 412 001.42
6	955 682.07	4 412 000
7	955 682.71	4 411 999.51
8	955 682.71	4 411 999.51
9	955 682.71	4 411 999.52
10	955 685.14	4 411 997.65
11	955 689.29	4 411 994.49
12	955 891.35	4 411 976.62
13	955 891.8	4 411 978.84
14	955 870.53	4 411 996.07

Перечень координат поворотных точек земельного участка 86:11:0902001:5307:3У1

Номер	X	Y
1	956 775.71	4 413 629.82
2	956 783.53	4 413 630.63
3	956 784.17	4 413 631.9
4	956 782.11	4 413 634.08
5	956 794.59	4 413 635.51
6	956 798.44	4 413 637.72
7	956 805.13	4 413 641.56
8	956 803.26	4 413 643.44
9	956 799.79	4 413 643.7
10	956 794.99	4 413 641.17
11	956 790.02	4 413 638.52
12	956 786.66	4 413 636.73
13	956 780.03	4 413 634.24
14	956 774.79	4 413 633
15	956 774.23	4 413 633.01

Перечень координат поворотных точек
земельного участка №6:11:0401001:1004:3У1

Номер	X	Y
1	954 933.16	4 419 778.6
2	954 933.89	4 419 770.19
3	954 935.78	4 419 761.99
4	954 932.82	4 419 761.28
5	954 930.91	4 419 770.05
6	954 930.18	4 419 778.46
7	954 933.52	4 419 771.87
8	954 933.71	4 419 769.67
9	954 931.41	4 419 769.48
10	954 931.23	4 419 771.65
11	954 918.36	4 419 946.46
12	954 919.79	4 419 929.5
13	954 916.79	4 419 929.26
14	954 915.37	4 419 946.18
15	954 911.03	4 420 029.88
16	954 912.46	4 420 012.92
17	954 909.45	4 420 012.68
18	954 908.04	4 420 029.82
19	954 215.73	4 424 264.73
20	954 215.8	4 424 263.48
21	954 221.45	4 424 263.73
22	954 221.66	4 424 260.48
23	954 214.7	4 424 260.15
24	954 212.92	4 424 261.7
25	954 212.51	4 424 264.58
26	954 268.83	4 424 265.52
27	954 266.98	4 424 262.53
28	954 250.04	4 424 261.76
29	954 249.9	4 424 264.73
30	954 260.19	4 424 265.03
31	954 260.34	4 424 262.83
32	954 258.04	4 424 262.69
33	954 257.9	4 424 264.87
34	954 319.87	4 424 270.18
35	954 320.24	4 424 263.96
36	954 315.57	4 424 263.67
37	954 315.2	4 424 269.92
38	954 319.48	4 424 268.07
39	954 319.63	4 424 265.88
40	954 317.33	4 424 265.74
41	954 317.19	4 424 287.92

Перечень координат поворотных точек
земельного участка №6:11:1001001:3У1

Номер	X	Y
1	955 686.4	4 409 541.78
2	955 677.05	4 409 537.31
3	955 689.27	4 409 524.5
4	955 668.84	4 409 522.94
5	955 670.28	4 409 520.37
6	955 683.09	4 409 512.59
7	955 684.31	4 409 513.47
8	955 676.76	4 409 517.19
9	955 678.15	4 409 519.48
10	955 670.93	4 409 523.86
11	955 678.69	4 409 536.7
12	955 685.15	4 409 539.69
13	955 708.9	4 409 684.67
14	955 706.89	4 409 684.58
15	955 711.81	4 409 584.2
16	955 713.8	4 409 587.54
17	955 706.98	4 409 702.94
18	955 706.58	4 409 690.65
19	955 708.59	4 409 690.74
20	955 707.93	4 409 703.81
21	955 696.42	4 409 504.43
22	955 695.44	4 409 505.25
23	955 695.18	4 409 504.9
24	955 700.49	4 409 512.34
25	955 700.18	4 409 511.9
26	955 700.54	4 409 511.79
27	955 699.97	4 409 509.91
28	955 700.02	4 409 510.01
29	955 701.19	4 409 511.93

Перечень координат поворотных точек
земельного участка №6:11:0901001:160:3У1

Номер	X	Y
1	955 714.16	4 409 842.36
2	955 712.71	4 409 833.82
3	955 713.14	4 409 825.16
4	955 716.14	4 409 825.31
5	955 715.72	4 409 833.64
6	955 717.11	4 409 841.86
7	955 713.51	4 409 835.62
8	955 713.12	4 409 833.43
9	955 715.39	4 409 833.04
10	955 715.76	4 409 835.23
11	955 729.05	4 409 913.77
12	955 729.05	4 409 913.77
13	955 728.67	4 409 911.6
14	955 726.41	4 409 912.02
15	955 726.41	4 409 912.01
16	955 728.67	4 409 911.59
17	955 828.6	4 410 055.29
18	955 827.7	4 410 052.42
19	955 830.54	4 410 051.53
20	955 836.36	4 410 048.75
21	955 838.38	4 410 052.78
22	955 834.6	4 410 054.6
23	955 833.91	4 410 053.24
24	955 831.63	4 410 054.34
25	955 819.23	4 410 065.59
26	955 816.23	4 410 065.53
27	955 816.45	4 410 055.96
28	955 825.58	4 410 053.09
29	955 826.48	4 410 055.96
30	955 819.39	4 410 058.18
31	955 818.73	4 410 058.68
32	955 816.49	4 410 058.22
33	955 816.91	4 410 056.05
34	955 819.17	4 410 056.51
35	955 762.32	4 410 075.78
36	955 753.36	4 410 072.92
37	955 751.75	4 410 063.65
38	955 754.72	4 410 063.15
39	955 758	4 410 070.62
40	955 763.23	4 410 072.92
41	955 755.71	4 410 072.94
42	955 753.47	4 410 072.49
43	955 753.89	4 410 070.31
44	955 756.15	4 410 070.77
45	955 818.02	4 410 094.78
46	955 813.66	4 410 094.23
47	955 814.07	4 410 088.37
48	955 818.5	4 410 088.47
49	955 817.9	4 410 092.76
50	955 815.66	4 410 092.3
51	955 816.08	4 410 090.12
52	955 818.28	4 410 090.58
53	955 742.87	4 410 476.1
54	955 740.38	4 410 474.42
55	955 744.96	4 410 467.59
56	955 746.76	4 410 459.57

Перечень координат поворотных точек земельного участка 86:11:0901001:160:1V/1

Номер	X	Y	Номер	X	Y
60	955 744.74	4 410 468.63	119	955 595.36	4 411 309.28
61	955 745.62	4 410 468.6	120	955 595.65	4 411 308.55
62	955 747.73	4 410 467.54	121	955 595.48	4 411 310.42
63	955 712.44	4 410 521.01	122	955 597.75	4 411 310.65
64	955 712.43	4 410 521.01	123	955 597.98	4 411 308.45
65	955 710.53	4 410 519.73	124	955 595.77	4 411 308.24
66	955 711.75	4 410 517.9	125	955 598.43	4 411 301.06
67	955 713.66	4 410 519.18	126	955 601.24	4 411 302.09
68	955 712.43	4 410 521	127	955 598.39	4 411 309.81
69	955 609.73	4 410 681.98	128	955 598.45	4 411 318.04
70	955 606.74	4 410 681.68	129	955 629.69	4 411 511.09
71	955 607.61	4 410 672.88	130	955 624.03	4 411 504.28
72	955 612.56	4 410 665.48	131	955 621.84	4 411 495.68
73	955 615.06	4 410 667.14	132	955 624.86	4 411 494.98
74	955 610.53	4 410 673.9	133	955 626.79	4 411 502.9
75	955 610.18	4 410 674.74	134	955 632	4 411 509.17
76	955 607.91	4 410 674.47	135	955 624.68	4 411 504.88
77	955 608.15	4 410 672.28	136	955 623.84	4 411 502.81
78	955 610.44	4 410 672.54	137	955 628.11	4 411 502.03
79	955 593.49	4 410 815.86	138	955 626.84	4 411 504.12
80	955 593.97	4 410 810.95	139	955 728.61	4 411 629.38
81	955 598.96	4 410 811.25	140	955 727.19	4 411 627.68
82	955 596.47	4 410 816.16	141	955 728.96	4 411 626.21
83	955 593.16	4 410 823.04	142	955 730.38	4 411 627.81
84	955 596.15	4 410 823.02	143	955 780.23	4 411 691.53
85	955 596.19	4 410 828.04	144	955 778.83	4 411 689.84
86	955 593.18	4 410 828.05	145	955 780.59	4 411 688.36
87	955 596.6	4 410 900.59	146		
88	955 593.6	4 410 900.58			
89	955 593.57	4 410 895.47			
90	955 596.56	4 410 895.44			
91	955 598.7	4 410 912.44			
92	955 593.7	4 410 912.46			
93	955 593.66	4 410 907.4			
94	955 596.66	4 410 907.39			
95	955 597.39	4 411 222.48			
96	955 596.32	4 411 220.23			
97	955 598.09	4 411 220.21			
98	955 598.06	4 411 217.99			
99	955 596.32	4 411 218.02			
100	955 598.18	4 411 215.8			
101	955 600.74	4 411 221.31			
102	955 621.87	4 411 237.47			
103	955 614.66	4 411 236.2			
104	955 612.48	4 411 231			
105	955 617.78	4 411 227.04			
106	955 623.01	4 411 232.34			
107	955 614.12	4 411 267.35			
108	955 611.29	4 411 266.3			
109	955 614.04	4 411 258.91			
110	955 612.2	4 411 254.98			
111	955 612.19	4 411 251.08			
112	955 613.41	4 411 250.51			
113	955 617.29	4 411 258.77			
114	955 616.6	4 411 280.03			
115	955 614.33	4 411 259.79			

Перечень координат поворотных точек земельного участка 86:11:0902001:5710:3V/1

Номер	X	Y
1	955 857.07	4 411 910.54
2	955 860.02	4 411 910.01
3	955 858.8	4 411 902.87
4	955 855.85	4 411 903.37
5	955 930.48	4 412 056.28
6	955 934.92	4 412 055.89
7	955 934.41	4 412 053.44
8	955 921.54	4 412 056.56
9	955 922.64	4 412 056.14
10	955 923.53	4 412 054.67
11	955 924.55	4 412 054.46
12	955 925.14	4 412 054.31
13	955 925.16	4 412 054.34
14	955 925.18	4 412 054.33
15	955 925.68	4 412 054.95
16	955 927.16	4 412 054.37
17	955 927.48	4 412 055.32
18	955 933.3	4 412 051.4
19	955 931.77	4 412 049.82
20	955 920.39	4 412 053.3
21	955 953.28	4 412 115.17
22	955 954.07	4 412 112.29
23	955 946.77	4 412 110.22
24	955 945.21	4 412 102.78
25	955 942.28	4 412 103.39
26	955 944.21	4 412 112.61
27	955 945.38	4 412 112.76
28	955 947.22	4 412 111.56
29	955 945.93	4 412 109.65
30	955 944.1	4 412 110.88
31	956 367.35	4 412 235.42
32	956 369.02	4 412 232.95
33	956 361.78	4 412 228.07
34	956 361.02	4 412 227.86
35	956 362.67	4 412 229.03
36	956 361.38	4 412 230.81
37	956 359.5	4 412 229.49
38	956 360.72	4 412 227.78
39	956 353.34	4 412 225.69
40	956 352.52	4 412 228.58
41	956 360.48	4 412 230.84
42	956 575.25	4 412 324.62
43	956 672.8	4 412 317.57
44	956 570.66	4 412 318.09
45	956 701.67	4 412 381.08
46	956 702.42	4 412 388.17
47	956 694.43	4 412 386.07
48	956 687.44	4 412 381.64
49	956 685.83	4 412 384.17
50	956 693.21	4 412 388.86
51	956 694.81	4 412 388.87
52	956 695.45	4 412 386.76
53	956 693.24	4 412 386.1
54	956 692.61	4 412 388.22
55	957 028.74	4 412 476.89
56	957 029.51	4 412 473.99

Номер	X	Y
60	957 012.29	4 412 472.56
61	957 020.52	4 412 474.72
62	957 020.53	4 412 474.72
63	957 021.57	4 412 474.55
64	957 022.21	4 412 472.45
65	957 020	4 412 471.78
66	957 019.37	4 412 473.9
67	957 082.16	4 412 490.9
68	957 082.93	4 412 488
69	957 074.71	4 412 485.84
70	957 074.7	4 412 485.83
71	957 066.48	4 412 483.68
72	957 065.72	4 412 486.59
73	957 073.93	4 412 488.73
74	957 073.94	4 412 488.73
75	957 076.86	4 412 489.1
76	957 077.5	4 412 486.99
77	957 075.29	4 412 485.33
78	957 074.66	4 412 488.45
79	957 136.02	4 412 505.01
80	957 135.98	4 412 501.92
81	957 125.6	4 412 499.19
82	957 125.48	4 412 499.63
83	957 124.93	4 412 501.77
84	957 124.85	4 412 502.09
85	957 134.31	4 412 504.33
86	957 134.96	4 412 502.22
87	957 132.74	4 412 501.55
88	957 132.11	4 412 503.67

Перечень координат поворотных точек земельного участка 86:11:0002001:5710:3У1

Перечень координат поворотных точек земельного участка 86:11:1001001:3058:3У1

Номер	X	Y	Номер	X	Y
90	957 097.05	4 413 201.57	150	956 045.93	4 415 806.02
91	957 095.49	4 413 199.02	151	956 044.42	4 415 803.43
92	957 080.99	4 413 207.87	152	956 029.73	4 415 812.01
93	957 088.5	4 413 206.36	153	955 762	4 416 035.93
94	957 090.33	4 413 205.09	154	955 764.93	4 416 028.36
95	957 089.05	4 413 203.21	155	955 771.03	4 416 023.01
96	957 087.21	4 413 204.43	156	955 769.05	4 416 020.75
97	957 007.64	4 413 256.27	157	955 762.4	4 416 026.59
98	957 022.16	4 413 247.41	158	955 759.21	4 416 034.66
99	957 020.59	4 413 244.85	159	955 764.16	4 416 029
100	957 006.08	4 413 253.71	160	955 765.04	4 416 026.97
101	957 013.96	4 413 251.93	161	955 762.95	4 416 026.15
102	957 015.8	4 413 250.67	162	955 762.02	4 416 028.15
103	957 014.51	4 413 248.79	163	955 607.16	4 416 486.37
104	957 012.67	4 413 250	164	955 608.78	4 416 484.56
105	956 937.17	4 413 304.63	165	955 607.39	4 416 484.13
106	956 940.56	4 413 297.33	166	955 606.74	4 416 486.23
107	956 947.42	4 413 293.13			

Перечень координат поворотных точек земельного участка 86:11:1001001:3058:3У1

108	956 945.86	4 413 290.56
109	956 938.23	4 413 295.22
110	956 934.46	4 413 303.36
111	956 939.87	4 413 298.09
112	956 940.79	4 413 296.07
113	956 938.72	4 413 295.12
114	956 937.78	4 413 297.11
115	956 675.08	4 413 682.36
116	956 676.68	4 413 679.82
117	956 669.03	4 413 674.99
118	956 666.92	4 413 677.45
119	956 668.75	4 413 679.01
120	956 669.04	4 413 678.56
121	956 704.66	4 413 701.19
122	956 712.71	4 413 701.05
123	956 714.36	4 413 697.78
124	956 705.51	4 413 698.18
125	956 698.72	4 413 693.86
126	956 697.12	4 413 696.39
127	956 705.88	4 413 701.11
128	956 706.47	4 413 699.82
129	956 706.8	4 413 699.09
130	956 704.73	4 413 698.14
131	956 704.64	4 413 698.33
132	956 703.79	4 413 700.12
133	956 752.12	4 413 702.13
134	956 754.72	4 413 696.5
135	956 750.74	4 413 694.65
136	956 748.13	4 413 700.28
137	956 752.85	4 413 700.41
138	956 753.77	4 413 698.4
139	956 751.7	4 413 697.44
140	956 750.76	4 413 699.43
141	956 107.9	4 415 769.78
142	956 122.58	4 415 761.19
143	956 121.07	4 415 758.61
144	956 106.39	4 415 767.19
145	956 117.79	4 415 763.7
146	956 119.73	4 415 762.64
147	956 118.62	4 415 760.64
148	956 118.68	4 415 761.68
149	956 031.24	4 415 814.61

Номер	X	Y
1	955 713.8	4 409 587.54
2	955 734.95	4 409 622.89
3	955 732.67	4 409 679.11
4	955 733.09	4 409 685.57
5	955 729.95	4 409 685.69
6	955 708.9	4 409 684.67
7	955 723.6	4 409 665.77
8	955 721.31	4 409 665.67
9	955 721.41	4 409 663.47
10	955 723.71	4 409 663.58
11	955 707.93	4 409 703.81
12	955 708.59	4 409 690.74
13	955 729.93	4 409 691.69
14	955 732.11	4 409 691.64
15	955 731.75	4 409 700.32
16	955 731.09	4 409 702.61
17	955 730.39	4 409 702.63
18	955 730.41	4 409 702.85
19	955 731.18	4 409 714.2
20	955 712.09	4 409 705.67
21	955 730.57	4 409 704.85
22	955 730.75	4 409 708.81
23	955 731.48	4 409 706.85
24	955 694.21	4 409 505.28
25	955 694.57	4 409 505.98
26	955 693.12	4 409 507.18
27	955 694.83	4 409 509.65
28	955 696.09	4 409 508.92
29	955 697.16	4 409 510.99
30	955 697.67	4 409 512.66
31	955 698.3	4 409 513.66
32	955 690.88	4 409 518.1
33	955 688.46	4 409 514.13
34	955 689.76	4 409 513.17
35	955 687.98	4 409 510.76
36	955 684.31	4 409 513.47
37	955 688.2	4 409 519.69
38	955 680.93	4 409 524.05
39	955 678.15	4 409 519.48
40	955 676.76	4 409 517.19

Номер	X	Y
1	955 698.3	4 409 513.66
2	955 707.97	4 408 528.82
3	955 738.82	4 409 577.03
4	955 734.95	4 409 622.89
5	955 713.8	4 409 587.54
6	955 711.81	4 409 584.2
7	955 686.4	4 409 541.78
8	955 685.15	4 409 539.69
9	955 677.14	4 409 526.32
10	955 680.93	4 409 524.05
11	955 688.21	4 409 519.7
12	955 696.16	4 409 532.79
13	955 698.72	4 409 531.24
14	955 690.88	4 409 518.1
15	955 727.79	4 409 581.33
16	955 725.51	4 409 581.27
17	955 725.56	4 409 579.06
18	955 727.85	4 409 579.11

Перечень координат поворотных точек земельного участка 86:11:0901001:159:3/1

Номер	X	Y
1	955 610.22	4 411 140.12
2	955 609.46	4 411 200.43
3	955 605.27	4 411 203.49
4	955 605.58	4 411 140.14
5	955 610.75	4 411 205.69
6	955 634.91	4 411 228.93
7	955 839.33	4 411 235.86
8	955 641.13	4 411 248.55
9	955 638.21	4 411 257.93
10	955 632.49	4 411 265.41
11	955 623.52	4 411 273.64
12	955 609.44	4 411 311.7
13	955 609.76	4 411 358.98
14	955 606.25	4 411 357.94
15	955 605.91	4 411 311.09
16	955 624.75	4 411 260.22
17	955 624.75	4 411 260.21
18	955 630.47	4 411 249.39
19	955 630.41	4 411 239.8
20	955 623.01	4 411 232.34
21	955 617.76	4 411 227.04
22	955 607.41	4 411 218.95
23	955 605.99	4 411 208.98
24	955 608.27	4 411 207.5
25	955 636.89	4 411 497.76
26	955 653.46	4 411 515.42
27	955 649.61	4 411 518.64
28	955 633.7	4 411 499.37
29	955 606.45	4 411 387.64
30	955 606.3	4 411 364.84
31	955 609.81	4 411 365.83
32	955 609.96	4 411 387.22
33	955 775.83	4 411 663.36
34	955 783.27	4 411 664.27
35	955 792.8	4 411 675.85
36	955 785.4	4 411 681.95
37	955 749.19	4 411 638.34
38	955 749.23	4 411 637.94
39	955 749.78	4 411 634.91
40	955 749.73	4 411 633.39
41	955 779.82	4 410 089.71
42	955 779.53	4 410 092.19
43	955 747.06	4 410 081.9
44	955 743.3	4 410 079.32
45	955 821.53	4 410 128.81
46	955 823.56	4 410 137.86
47	955 820.23	4 410 167.27
48	955 812.93	4 410 191.2

Перечень координат поворотных точек земельного участка 86:11:0000000:69432:3/1

Номер	X	Y
1	957 170.31	4 412 524.87
2	957 170.28	4 412 521.76
3	957 170.1	4 412 503.1
4	957 170.06	4 412 498.86
5	957 170.02	4 412 494.71
6	957 160.09	4 412 492.24
7	957 156.87	4 412 488.41
8	957 152.64	4 412 479.34
9	957 144.18	4 412 477.65
10	957 141.49	4 412 483.09
11	957 137.34	4 412 485.29
12	957 137.23	4 412 516.15
13	957 055.54	4 413 254.89
14	957 082.88	4 413 254.33
15	957 069.71	4 413 234.11
16	957 078.76	4 413 228.57
17	957 078.46	4 413 225.6
18	957 078.08	4 413 221.91
19	957 076.18	4 413 203.2
20	957 064.48	4 413 210.29
21	957 060.5	4 413 206.79
22	957 055.52	4 413 209.04
23	957 058.32	4 413 215.41
24	957 046.12	4 413 222.27
25	957 047.03	4 413 240.93
26	957 048	4 413 250.45
27	957 052.1	4 413 251.45
28	955 046.56	4 418 560.9
29	955 047.5	4 418 560.54
30	955 060.91	4 418 555.37
31	955 068.41	4 418 552.48
32	955 069.88	4 418 551.91
33	955 069.1	4 418 546.76
34	955 075.23	4 418 525.36
35	955 066.53	4 418 503.89
36	955 068.42	4 418 494.51
37	955 064.69	4 418 502.68
38	955 056.22	4 418 521.24
39	955 054.39	4 418 525.25
40	955 043.21	4 418 529.42
41	955 042.28	4 418 529.77

Перечень координат поворотных точек земельного участка 86:11:0000000:69428:3/1

Номер	X	Y
1	955 706.24	4 410 556.22
2	955 715.18	4 410 542.82
3	955 712.54	4 410 541.22
4	955 696.13	4 410 531.27
5	955 695.16	4 410 530.31
6	955 687.81	4 410 541.3
7	955 691.76	4 410 577.89
8	955 705.11	4 410 557.88
9	955 686.69	4 410 542.98
10	955 673.3	4 410 563.01
11	955 689.32	4 410 575.92
12	955 656	4 410 622.61
13	955 659.39	4 410 618.86
14	955 674.63	4 410 601.79
15	955 673.04	4 410 600.25
16	955 658.06	4 410 585.78
17	955 648	4 410 600.82
18	955 641.04	4 410 596.21
19	955 636.22	4 410 603.48
20	955 642.99	4 410 610.03
21	955 662.07	4 412 000
22	955 662.71	4 411 999.51
23	955 659.9	4 411 993.64
24	955 662.62	4 411 992.27
25	955 665.14	4 411 997.65
26	955 669.29	4 411 994.49
27	955 691.35	4 411 976.62
28	955 690.09	4 411 970.35
29	955 682.57	4 411 953.08
30	955 680.07	4 411 938.36
31	955 677.91	4 411 940.08
32	955 666.37	4 411 949.29
33	955 668.4	4 411 961.01
34	955 666.14	4 411 961.42
35	955 664.32	4 411 950.92
36	955 652.89	4 411 960.05
37	955 650.84	4 411 961.69
38	955 656.01	4 411 994.13
39	955 671.06	4 411 891.13
40	955 673.32	4 411 890.73
41	955 672.94	4 411 988.55
42	955 670.88	4 411 988.97
43	955 669.38	4 412 007.08
44	955 691.57	4 411 989.72
45	955 693.75	4 411 988.02
46	955 691.8	4 411 978.84
47	955 670.53	4 411 996.07
48	955 663.53	4 412 001.42
49	954 939.73	4 419 869.59
50	954 942.48	4 419 838.39
51	954 948.44	4 419 837.01
52	954 935.84	4 419 833.91
53	954 919.8	4 419 823.11
54	954 917.08	4 419 853.91
55	954 923.14	4 419 858.11
56	954 925.99	4 419 860.08

Номер	X	Y
60	954 928.17	4 419 833.4
61	954 925.88	4 419 833.2
62	954 925.69	4 419 835.36

Номер	X	Y	Номер	X	Y	Номер	X	Y
1	955 295.42	4 417 244.63	61	955 064.69	4 418 502.68	121	954 963.77	4 418 999.75
2	955 293.73	4 417 243.13	62	955 064.59	4 418 499.71	122	954 964.72	4 418 999.27
3	955 293.26	4 417 243.66	63	955 105.26	4 418 290.34	123	954 964.73	4 418 999.23
4	955 291.95	4 417 229.9	64	955 106.31	4 418 297.4	124	954 988.16	4 418 002.89
5	955 294.84	4 417 226.79	65	955 107.06	4 418 303.08	125	954 987.44	4 419 007.1
6	955 309.83	4 417 226.26	66	955 088.42	4 418 494.51	126	954 986.27	4 419 006.98
7	955 316.76	4 417 232.01	67	955 080.55	4 418 632.69	127	954 986.81	4 419 003.29
8	955 321.22	4 417 230.74	68	955 068.41	4 418 552.48	128	954 972.17	4 419 006.54
9	955 334.48	4 417 222.91	69	955 069.88	4 418 551.91	129	954 971.45	4 419 011.34
10	955 333.1	4 417 227.57	70	955 081.21	4 418 627.32	130	954 967.26	4 419 007
11	955 321.05	4 417 232.32	71	955 069.13	4 418 724.95	131	954 983.25	4 419 205.46
12	955 305.87	4 417 231.7	72	955 046.56	4 418 560.9	132	954 983.21	4 419 073.42
13	955 140.88	4 418 138.55	73	955 047.5	4 418 560.54	133	954 987.98	4 419 041.29
14	955 138.98	4 418 154.21	74	955 069.61	4 418 721.03	134	954 987.32	4 419 033.76
15	955 136.26	4 418 146.05	75	955 064.46	4 418 764.57	135	954 987.73	4 419 031.13
16	955 136.22	4 418 176.98	76	955 064.21	4 418 766.59	136	954 989.43	4 419 037.28
17	955 136.07	4 418 178.3	77	954 993.69	4 418 862.72	137	954 989.87	4 419 044.46
18	955 135.06	4 418 188.55	78	954 975.37	4 418 985.09	138	954 985.12	4 419 078.38
19	955 128.19	4 418 198.99	79	954 966.02	4 418 986.22	139	954 985.16	4 419 202.63
20	955 123.86	4 418 221.08	80	954 959.8	4 418 990.2	140	954 983.36	4 419 438.76
21	955 124.29	4 418 237.47	81	954 955.02	4 418 997.34	141	954 983.34	4 419 438.91
22	955 122.38	4 418 235.95	82	954 954.64	4 419 000.11	142	954 983.25	4 419 243.52
23	955 121.89	4 418 217.35	83	954 954.25	4 419 002.87	143	954 988.76	4 419 223.84
24	955 127	4 418 192.2	84	954 956.34	4 419 010.15	144	954 987.92	4 419 215.17
25	955 096.76	4 418 232.68	85	954 961.06	4 419 016.09	145	954 990.79	4 419 221.91
26	955 097.85	4 418 233.57	86	954 969.99	4 419 021.05	146	954 990.67	4 419 226.47
27	955 090.7	4 418 268.8	87	954 988.64	4 419 030.19	147	954 985.31	4 419 244.98
28	955 089.36	4 418 268.16	88	954 967.86	4 419 030.1	148	954 985.27	4 419 421.57
29	955 110.12	4 418 243.52	89	954 968.26	4 419 027.26	149	954 983.62	4 419 502.31
30	955 113.64	4 418 246.39	90	954 958.11	4 419 021.17	150	954 985.26	4 419 514.06
31	955 114.33	4 418 272.26	91	954 954.16	4 419 016.84	151	954 985.26	4 419 518.66
32	955 111.2	4 418 278.62	92	954 951.45	4 419 011.66	152	954 983.34	4 419 518.47
33	955 109.8	4 418 277.96	93	954 950.2	4 419 005.95	153	954 971.39	4 419 641.31
34	955 108.29	4 418 266.78	94	954 950.95	4 418 999.67	154	954 967.17	4 419 639.57
35	955 105.64	4 418 265.61	95	954 952.07	4 418 996.29	155	954 974.33	4 419 604.25
36	955 122.84	4 418 253.85	96	954 954.76	4 418 992.77	156	954 984.08	4 419 606.16
37	955 124.76	4 418 255.41	97	954 958.82	4 418 988.87	157	954 986.95	4 419 591.43
38	955 125.12	4 418 268.49	98	954 964.68	4 418 985.97	158	954 983.36	4 419 578.52
39	955 123.56	4 418 281.29	99	954 974.63	4 418 984.35	159	954 983.34	4 419 520.47
40	955 122.59	4 418 283.91	100	954 982.64	4 418 930.4	160	954 985.26	4 419 520.66
41	955 119.46	4 418 282.46	101	954 992.69	4 418 862.46	161	954 985.25	4 419 582.31
42	955 120.43	4 418 281.22	102	955 059.38	4 418 807.77	162	954 991.23	4 419 591.52
43	955 123.35	4 418 273.31	103	955 058.71	4 418 813.48	163	954 991.22	4 419 606.52
44	955 042.28	4 418 529.77	104	955 015.68	4 418 870.54	164	954 988.21	4 419 609.52
45	955 039.32	4 418 508.26	105	955 000.03	4 418 975.52	165	954 978.54	4 419 609.51
46	955 075.31	4 418 335.5	106	954 998.43	4 418 979.77			
47	955 088.94	4 418 270.18	107	954 996.12	4 418 984.11			
48	955 090.29	4 418 270.82	108	954 993.39	4 418 987.97			
49	955 041.04	4 418 513.64	109	954 989.79	4 418 991.82			
50	955 043.21	4 418 529.41	110	954 988.16	4 419 002.89			
51	955 100.8	4 418 289.49	111	954 987.3	4 419 000.02			
52	955 103.32	4 418 277.07	112	954 989.32	4 418 986.43			
53	955 103.66	4 418 277.22	113	954 989.32	4 418 986.44			
54	955 104.7	4 418 285.19	114	954 988.28	4 418 971.82			
55	955 121.79	4 418 285.73	115	955 013.92	4 418 866.61			
56	955 118.28	4 418 291.2	116	954 973.96	4 418 994.56			
57	955 112.28	4 418 296.22	117	954 972.29	4 419 005.7			

Перечень координат поворотных точек
земельного участка 86:11:0000000:96:1У1

Номер	X	Y
1	955 856.23	4 411 782.83
2	955 854.64	4 411 786.26
3	955 852.13	4 411 783.19
4	955 855.78	4 411 760.14
5	956 067.37	4 412 160.54
6	956 049.9	4 412 155.58
7	956 052.73	4 412 136.15
8	956 054.59	4 412 125
9	956 072.01	4 412 129.96
10	956 070.51	4 412 138.99
11	956 067.66	4 412 168.57
12	955 766.77	4 410 451.05
13	955 768.51	4 410 441.25
14	955 776.37	4 410 397.27
15	955 788.35	4 410 313.77
16	955 799.33	4 410 237.07
17	955 813.45	4 410 191.43
18	955 826.31	4 410 149.15
19	955 832.66	4 410 126.73
20	955 815.86	4 410 231.9
21	955 813.24	4 411 183.85
22	955 811.39	4 411 181.11
23	955 809.89	4 411 084.35
24	955 608.43	4 410 980.45
25	955 607.53	4 410 890.83
26	955 607.77	4 410 879.19
27	955 608.35	4 410 852.09
28	955 609.39	4 410 833.35
29	955 609.55	4 410 831.01
30	955 612.47	4 410 784.61
31	955 614.23	4 410 733.09
32	955 615.85	4 410 686.77
33	955 617.81	4 410 679.77
34	955 829.31	4 410 664.73
35	955 839.21	4 410 649.83
36	955 649.67	4 410 629.69
37	955 656.01	4 410 622.63
38	955 659.39	4 410 618.87
39	955 674.63	4 410 601.79
40	955 685.69	4 410 616.86
41	955 624.94	4 410 678.5
42	955 611.02	4 410 819.24

Перечень координат поворотных точек земельного участка 86:11:0901001:3У1

Номер	X	Y	Номер	X	Y
1	955 705.98	4 409 702.94	61	955 804.23	4 410 066.04
2	955 707.93	4 409 703.81	62	955 803.8	4 410 069.02
3	955 705.93	4 409 703.89	63	955 803.1	4 410 073.86
4	955 707.77	4 409 705.86	64	955 802.45	4 410 077.38
5	955 701.66	4 408 834.44	65	955 799.96	4 410 076.6
6	955 742.38	4 410 074.04	66	955 797.46	4 410 075.82
7	955 736.15	4 410 048.69	67	955 797.45	4 410 075.82
8	955 899.57	4 409 833.48	68	955 808.36	4 410 066.98
9	955 705.83	4 409 705.95	69	955 807.49	4 410 078.96
10	955 829.94	4 410 039.37	70	955 803.47	4 410 077.7
11	955 831.58	4 410 042.35	71	955 804.07	4 410 074.2
12	955 820.02	4 410 046.1	72	955 804.78	4 410 069.24
13	955 712.54	4 410 541.22	73	955 805.21	4 410 066.26
14	955 758.07	4 410 473.17	74	955 780.83	4 410 090
15	955 776.82	4 410 390.16	75	955 789.85	4 410 092.65
16	955 787.76	4 410 313.53	76	955 789.6	4 410 095.11
17	955 798.73	4 410 236.85	77	955 789.57	4 410 095.38
18	955 799.74	4 410 233.68	78	955 780.53	4 410 092.52
19	955 799.85	4 410 233.29	79	955 795.22	4 410 097.17
20	955 800.78	4 410 230.28	80	955 795.22	4 410 097.15
21	955 801.48	4 410 228.03	81	955 795.24	4 410 097.02
22	955 812.93	4 410 191.2	82	955 795.52	4 410 094.31
23	955 818.76	4 410 172.09	83	955 799.16	4 410 095.38
24	955 820.23	4 410 167.28	84	955 798.62	4 410 098.25
25	955 823.56	4 410 137.66	85	955 800.16	4 410 095.68
26	955 821.53	4 410 128.81	86	955 807.27	4 410 097.76
27	955 827.81	4 410 064.42	87	955 806.88	4 410 100.86
28	955 838.57	4 410 060.37	88	955 799.59	4 410 098.55
29	955 838.36	4 410 052.76	89	955 689.31	4 410 575.92
30	955 836.36	4 410 048.75	90	955 691.77	4 410 577.89
31	955 835.76	4 410 047.23	91	955 679.26	4 410 596.62
32	955 833.91	4 410 042.54	92	955 674.63	4 410 601.79
33	955 835.42	4 410 042.24	93	955 673.04	4 410 600.25
34	955 836.33	4 410 046.69	94	955 636.22	4 410 603.48
35	955 845.51	4 410 064.06	95	955 642.99	4 410 610.03
36	955 834.4	4 410 071.55	96	955 629.56	4 410 613.54
37	955 833.71	4 410 086.19	97	955 613.33	4 411 197.39
38	955 837.03	4 410 099.38	98	955 611.81	4 411 198.73
39	955 832.85	4 410 126.73	99	955 609.46	4 411 200.43
40	955 826.3	4 410 149.15	100	955 610.22	4 411 140.12
41	955 813.45	4 410 191.43	101	955 610.61	4 411 130.35
42	955 799.34	4 410 237.07	102	955 611.39	4 411 181.11
43	955 788.34	4 410 313.77	103	955 613.24	4 411 183.85
44	955 776.37	4 410 397.27	104	955 614.31	4 411 203.1
45	955 768.51	4 410 441.25	105	955 616.58	4 411 207.55
46	955 766.78	4 410 450.95	106	955 626.38	4 411 215.59
47	955 761.88	4 410 472.88	107	955 635.77	4 411 223.36
48	955 715.18	4 410 642.82	108	955 642.02	4 411 233.37
49	955 781.97	4 410 071.5	109	955 644.18	4 411 240.25
50	955 785.6	4 410 064.34	110	955 644.42	4 411 250.31
51	955 764.34	4 410 056.9	111	955 639.73	4 411 261.05
52	955 782.85	4 410 061.14	112	955 630.91	4 411 270.18
53	955 792.48	4 410 066.57	113	955 627.02	4 411 274.13
54	955 792.02	4 410 071.19	114	955 613.29	4 411 311.23
55	955 791.73	4 410 074.03	115	955 613.64	4 411 360.14
56	955 782.99	4 410 071.83	116	955 609.76	4 411 358.99
57	955 783.82	4 410 061.37	117	955 609.44	4 411 311.7

Номер	X	Y
121	955 636 22	4 411 257 88
122	955 636 23	4 411 257 88
123	955 636 24	4 411 257 85
124	955 640 05	4 411 252 03
125	955 641 13	4 411 248 56
126	955 641 13	4 411 248 55
127	955 639 33	4 411 235 86
128	955 634 91	4 411 228 93
129	955 610 75	4 411 205 69
130	955 613 24	4 411 203 88
131	955 617 76	4 411 227 04
132	955 612 47	4 411 230 99
133	955 610 47	4 411 226 24
134	955 607 41	4 411 218 96
135	955 623 01	4 411 232 36
136	955 630 41	4 411 239 8
137	955 630 47	4 411 249 39
138	955 624 75	4 411 260 21
139	955 619 47	4 411 247 66
140	955 621 87	4 411 237 47
141	955 721 73	4 411 593 03
142	955 717 3	4 411 592 12
143	955 653 46	4 411 515 43
144	955 653 46	4 411 515 42
145	955 636 89	4 411 497 76
146	955 609 97	4 411 387 23
147	955 609 81	4 411 365 83
148	955 613 67	4 411 366 9
149	955 613 82	4 411 385 85
150	955 640 48	4 411 495 38
151	955 720 1	4 411 597 78
152	955 726 91	4 411 599 26
153	955 744 36	4 411 620 23
154	955 744 2	4 411 626 78
155	955 794 28	4 411 677 63
156	955 792 8	4 411 675 65
157	955 783 28	4 411 664 27
158	955 775 83	4 411 663 36
159	955 749 73	4 411 633 39
160	955 749 68	4 411 633 35
161	955 749 62	4 411 626 55
162	955 776 12	4 411 659 41
163	955 786 54	4 411 661 51
164	955 796 75	4 411 675
165	955 750 31	4 411 676 14
166	955 749 8	4 411 673 61
167	955 750 87	4 411 672 73
168	955 749 61	4 411 671 18
169	955 749 35	4 411 671 4
170	955 748 44	4 411 666 9
171	955 748 38	4 411 665 55
172	955 775 57	4 411 698 28
173	955 771 6	4 411 701 8

Номер	X	Y	Номер	X	Y
1	954 923 25	4 419 771 6	60	954 333 48	4 424 016 54
2	954 923 5	4 419 768 71	61	954 332 04	4 424 016 4
3	954 929 61	4 419 739 05	62	954 331 69	4 424 019 79
4	954 927 01	4 419 738 58	63	954 286 29	4 424 262 78
5	954 920 94	4 419 765 5	64	954 286 51	4 424 258 83
6	954 920 24	4 419 770 94	65	954 278 29	4 424 258 65
7	954 942 49	4 419 838 39	66	954 272 29	4 424 258 63
8	954 948 4	4 419 771 32	67	954 269 71	4 424 258 73
9	954 967 12	4 419 687 91	68	954 285 24	4 424 282 11
10	954 974 69	4 419 681 23	69	954 285 5	4 424 277 3
11	954 978 79	4 419 662 75	70	954 211 6	4 424 273 81
12	954 973 26	4 419 660 76	71	954 210 83	4 424 276 55
13	954 970 32	4 419 677 1	72	954 213 39	4 424 279 94
14	954 962 79	4 419 684 15	73	954 228 65	4 424 282 06
15	954 946 51	4 419 767 95	74	954 233 82	4 424 276 78
16	954 940 44	4 419 837 01	75	954 257 16	4 424 280 03
17	954 906 23	4 420 226 04	76	954 308 45	4 424 283 33
18	954 909 38	4 420 214 19	77	954 308 76	4 424 278 41
19	954 939 74	4 419 869 6	78	954 293 73	4 424 277 69
20	954 937 68	4 419 868 17	79	954 293 32	4 424 282 71
21	954 334 74	4 424 020 1	80	954 297 58	4 424 283 02
22	954 383 19	4 423 547 32	81	954 297 61	4 424 281 6
23	954 387 42	4 423 478 42	82	954 298 69	4 424 281 7
24	954 390 52	4 423 442 89	83	954 298 72	4 424 281 47
25	954 389 69	4 423 442 81	84	954 299 7	4 424 281 55
26	954 383 4	4 423 505 44	85	954 299 68	4 424 281 78
27	954 384 87	4 423 505 57	86	954 307 32	4 424 282 47
28	954 384 58	4 423 508 59	87	954 273 08	4 425 213 31
29	954 383 1	4 423 508 45	88	954 280 5	4 425 209 18
30	954 377 26	4 423 566 64	89	954 301 13	4 424 879 65
31	954 378 64	4 423 566 76	90	954 295 88	4 424 879 32
32	954 378 34	4 423 569 75	91	954 334 28	4 424 267 1
33	954 376 95	4 423 569 82	92	954 346 08	4 424 151 6
34	954 370 58	4 423 633	93	954 348 37	4 424 114 22
35	954 372 05	4 423 633 14	94	954 332 68	4 424 264 07
36	954 371 77	4 423 636 12			
37	954 370 27	4 423 635 98			
38	954 364 74	4 423 691 13			
39	954 366 18	4 423 691 27			
40	954 365 89	4 423 694 26			
41	954 364 44	4 423 694 11			
42	954 357 4	4 423 764 22			
43	954 358 99	4 423 764 37			
44	954 358 69	4 423 767 36			
45	954 357 09	4 423 767 22			
46	954 351 23	4 423 825 6			
47	954 352 58	4 423 825 72			
48	954 352 29	4 423 828 71			
49	954 350 93	4 423 828 58			
50	954 344 91	4 423 888 39			
51	954 346 5	4 423 888 54			
52	954 346 21	4 423 891 52			
53	954 344 61	4 423 891 36			
54	954 338 73	4 423 949 82			
55	954 339 94	4 423 949 94			
56	954 339 66	4 423 952 92			

Перечень координат поворотных точек земельного участка №6:11-0903001-415-3У1

Перечень координат поворотных точек земельного участка №6:11-0902001-572-3У1

Номер	X	Y	Номер	X	Y
1	955 180.48	4 417 996.33	60	954 964.97	4 419 009.69
2	955 150.03	4 418 063.29	61	954 964.83	4 419 010.68
3	955 140.88	4 418 138.55	62	954 963.84	4 419 010.54
4	955 136.27	4 418 146.05	63	954 967.32	4 419 033.76
5	955 138.98	4 418 154.21	64	954 987.98	4 419 041.29
6	955 136.22	4 418 176.98	65	954 983.21	4 419 073.42
7	955 127	4 418 192.2	66	954 983.25	4 419 205.47
8	955 121.89	4 418 217.35	67	954 981.12	4 419 208.63
9	955 122.38	4 418 235.95	68	954 981.36	4 419 077.94
10	955 113.14	4 418 228.83	69	954 986.21	4 419 212.07
11	955 159.37	4 418 000.75	70	954 987.92	4 419 215.17
12	955 113.65	4 418 246.39	71	954 988.76	4 419 223.84
13	955 122.84	4 418 253.85	72	954 983.25	4 419 243.52
14	955 123.35	4 418 273.3	73	954 983.34	4 419 438.91
15	955 120.43	4 418 281.22	74	954 979.38	4 419 471.8
16	955 119.46	4 418 282.46	75	954 983.62	4 419 502.31
17	955 111.2	4 418 278.62	76	954 983.34	4 419 518.47
18	955 114.33	4 418 272.28	77	954 978.4	4 419 517.99
19	955 110.2	4 418 280.35	78	954 977.93	4 419 304.27
20	955 118.21	4 418 284.07	79	954 980.94	4 419 304.28
21	955 114.35	4 418 288.99	80	954 981.1	4 419 219.63
22	955 111.64	4 418 291.03	81	954 981.1	4 419 219.62
23	955 104.7	4 418 285.19	82	954 981.1	4 419 219.61
24	955 106.31	4 418 297.4	83	954 978.4	4 419 519.99
25	955 105.26	4 418 299.34	84	954 983.34	4 419 520.47
26	955 084.59	4 418 499.71	85	954 983.36	4 419 578.52
27	955 064.69	4 418 502.68	86	954 986.95	4 419 591.43
28	955 056.22	4 418 521.24	87	954 984.08	4 419 606.16
29	955 056.46	4 418 508.07	88	954 974.33	4 419 604.25
30	955 100.8	4 418 289.49	89	954 978.54	4 419 583.46
31	955 080.55	4 418 632.72			
32	955 076.3	4 418 667			
33	955 080.91	4 418 555.37			
34	955 068.41	4 418 552.48			
35	955 060.91	4 418 794.75			
36	955 059.38	4 418 807.77			
37	955 013.91	4 418 866.61			
38	954 998.28	4 418 971.82			
39	954 989.32	4 418 986.44			
40	955 007.01	4 418 868.21			
41	954 973.96	4 418 994.56			
42	954 964.76	4 418 999.26			
43	954 964.73	4 418 999.23			
44	954 964.72	4 418 999.27			
45	954 963.78	4 418 999.75			
46	954 963.34	4 419 002.94			
47	954 964.04	4 419 003.68			
48	954 963.46	4 419 007.36			
49	954 967.26	4 419 007			
50	954 971.45	4 419 011.34			
51	954 970	4 419 021.05			
52	954 961.06	4 419 016.09			
53	954 956.35	4 419 010.15			
54	954 954.26	4 419 002.87			
55	954 955.01	4 418 997.34			
56	954 959.8	4 418 990.2			

Номер	X	Y
80	955 679.58	4 416 297.65
81	955 673.05	4 416 298.24
82	955 674.89	4 416 292.3
83	955 681.58	4 416 291.23
84	955 659.37	4 416 362.63
85	955 653.83	4 416 380.3
86	955 670.41	4 416 306.77
87	955 676.92	4 416 306.2
88	955 651.44	4 416 368.03
89	955 685.67	4 416 374.03
90	955 667.83	4 416 376.88
91	955 667.01	4 416 376.52
92	955 650.65	4 416 370.6
93	955 650.05	4 416 372.52
94	955 666.27	4 416 378.39
95	955 670.6	4 416 380.26
96	955 675.02	4 416 386.96
97	955 684.82	4 416 394.24
98	955 654.87	4 416 389.7
99	955 648.35	4 416 378.02
100	955 656.51	4 416 392.77
101	955 683.68	4 416 396.51
102	955 659.51	4 416 409.3
103	955 651.13	4 416 406.07
104	955 643.7	4 416 426.88
105	955 650.61	4 416 429.56
106	955 634.94	4 416 455.21

Номер	X	Y
1	956 025.55	4 412 146.62
2	956 009.96	4 412 155.85
3	956 004.72	4 412 154.85
4	956 000.02	4 412 154.59
5	955 992.9	4 412 154.49
6	956 013.53	4 412 143.2
7	956 787.49	4 412 398.96
8	957 050.77	4 412 468.02
9	957 058.36	4 412 473.81
10	956 786.54	4 412 402.57
11	957 080.05	4 412 492.86
12	957 109.79	4 412 505.9
13	957 099.81	4 412 506.73
14	957 064.41	4 412 497.44
15	957 275.02	4 412 530.61
16	957 170.1	4 412 503.1
17	957 170.06	4 412 498.86
18	957 275.17	4 412 524.77
19	957 259.85	4 413 117.31
20	957 178.82	4 413 165.71
21	957 161.65	4 413 175.97
22	957 155.71	4 413 179.52
23	957 151.87	4 413 176.85
24	957 260.02	4 413 110.63
25	957 132.93	4 413 188.36
26	957 138.59	4 413 190.9
27	957 078.46	4 413 225.6
28	957 078.08	4 413 221.91
29	956 805.82	4 413 623.42
30	956 809.26	4 413 630.33
31	956 810.84	4 413 633.49
32	956 810.21	4 413 635.71
33	956 796.28	4 413 627.47
34	956 946.42	4 413 302.44
35	957 047.02	4 413 240.9
36	957 047.99	4 413 250.44
37	957 041.79	4 413 247.83
38	956 949.02	4 413 304.67
39	956 888.3	4 413 435.42
40	956 803.31	4 413 618.4
41	956 790.02	4 413 638.52
42	956 794.99	4 413 641.17
43	956 791.83	4 413 643.15
44	956 709.75	4 413 819.85
45	956 627.22	4 413 997.69
46	956 621.61	4 413 997.43
47	955 960.43	4 415 870.41
48	955 818.99	4 416 007.61
49	955 775.58	4 416 031.78
50	955 770.27	4 416 058.04
51	955 760.95	4 416 054.42
52	955 769.63	4 416 031.55
53	955 811.54	4 416 000.36
54	955 957.38	4 415 866.93
55	955 706.83	4 416 222.8
56	955 698.51	4 416 236.8

Перечень координат поворотных точек земельного участка №:11:0902001:3У1

Лист 53 из 134

Номер	X	Y	Номер	X	Y	Номер	X	Y
1	955 852.13	4 411 763.19	61	955 990.35	4 412 154.3	121	956 541.34	4 412 358.62
2	955 854.64	4 411 766.26	62	955 991.14	4 412 151.27	122	956 666.37	4 412 342.97
3	955 851.85	4 411 772.28	63	955 991.92	4 412 151.5	123	956 666.8	4 412 342.72
4	955 872.96	4 411 896.62	64	955 993.9	4 412 143.68	124	956 673.24	4 412 344.92
5	955 868.94	4 411 897.3	65	955 993.11	4 412 143.42	125	956 677.88	4 412 356.88
6	955 847.9	4 411 773.23	66	955 993.6	4 412 141.35	126	956 670.91	4 412 352.37
7	955 852.64	4 411 764.46	67	955 992.14	4 412 140.98	127	956 673.16	4 412 348.36
8	955 833.93	4 411 839.81	68	956 067.37	4 412 160.54	128	956 768.58	4 412 394.84
9	955 833.93	4 411 839.82	69	956 067.66	4 412 158.57	129	956 857.11	4 412 413.05
10	955 835	4 411 846.35	70	956 212.49	4 412 199.71	130	957 052.43	4 412 484.29
11	955 833.7	4 411 846.59	71	956 210.9	4 412 201.34	131	957 082.05	4 412 471.54
12	955 835.09	4 411 854.06	72	956 237.46	4 412 177.03	132	957 122.36	4 412 487.41
13	955 836.5	4 411 853.8	73	956 247.18	4 412 179.79	133	957 135.79	4 412 486.11
14	955 844.88	4 411 901.43	74	956 244.08	4 412 183.05	134	957 135.83	4 412 489.84
15	955 841.32	4 411 902.09	75	956 234.29	4 412 180.28	135	957 123.36	4 412 490.85
16	955 837.07	4 411 875.43	76	956 255.64	4 412 182.21	136	957 058.36	4 412 473.81
17	955 832.67	4 411 848.05	77	956 258.82	4 412 184.68	137	957 050.77	4 412 468.02
18	955 878	4 411 926.22	78	956 259.93	4 412 183.43	138	956 787.49	4 412 398.96
19	955 880.07	4 411 938.36	79	956 368.91	4 412 214.44	139	957 049.4	4 412 490.1
20	955 877.91	4 411 940.08	80	956 465.77	4 412 279.17	140	957 060.05	4 412 492.88
21	955 875.85	4 411 927.96	81	956 457.81	4 412 289.49	141	957 064.41	4 412 497.44
22	955 846.41	4 411 933.92	82	956 462.78	4 412 283.03	142	957 099.81	4 412 506.73
23	955 849.43	4 411 939.69	83	956 366.32	4 412 217.77	143	957 109.79	4 412 505.9
24	955 847.38	4 411 940	84	956 246.23	4 412 183.67	144	957 138.11	4 412 512.8
25	955 848.33	4 411 945.95	85	956 249.32	4 412 180.41	145	957 138.15	4 412 515.87
26	955 850.44	4 411 945.63	86	956 255.17	4 412 198.16	146	957 108.34	4 412 508.57
27	955 852.89	4 411 960.05	87	956 255.14	4 412 198.27	147	957 100.61	4 412 508.91
28	955 850.84	4 411 961.89	88	956 255.13	4 412 198.27	148	957 064.54	4 412 499.52
29	955 992.68	4 412 106.87	89	956 255.16	4 412 198.16	149	957 060.38	4 412 495.99
30	955 990.92	4 412 112.34	90	956 213.08	4 412 201.96	150	957 048.66	4 412 492.92
31	955 959.12	4 412 099.45	91	956 214.66	4 412 200.33	151	957 275.28	4 412 520.82
32	955 946.03	4 412 046	92	956 224.92	4 412 203.24	152	957 275.18	4 412 524.78
33	955 891.57	4 411 989.72	93	956 223.37	4 412 204.88	153	957 170.06	4 412 498.86
34	955 893.75	4 411 988.02	94	956 227.09	4 412 203.86	154	957 170.02	4 412 494.71
35	955 948.39	4 412 045.04	95	956 250.51	4 412 210.51	155	957 274.55	4 412 549.08
36	955 957.89	4 412 090.1	96	956 249.96	4 412 212.43	156	957 274.5	4 412 551.48
37	955 960.59	4 412 094.64	97	956 225.54	4 412 205.5	157	957 170.31	4 412 524.67
38	955 968.46	4 412 099.97	98	956 457.81	4 412 289.49	158	957 170.28	4 412 521.76
39	955 990.2	4 412 106.71	99	956 449.75	4 412 283.6	159	957 258.85	4 413 117.31
40	956 043.83	4 412 124.75	100	956 442.54	4 412 293.44	160	957 259.8	4 413 119.38
41	956 053.41	4 412 124.67	101	956 442.53	4 412 293.43	161	957 179.6	4 413 166.92
42	956 054.59	4 412 125.01	102	956 449.74	4 412 283.59	162	957 178.83	4 413 165.72
43	956 052.73	4 412 136.15	103	956 657.57	4 412 338.79	163	957 161.65	4 413 175.97
44	956 049.9	4 412 155.58	104	956 856.58	4 412 341.72	164	957 162.53	4 413 177.35
45	956 026.83	4 412 149.03	105	956 655.96	4 412 343.19	165	957 157.25	4 413 180.58
46	956 013.46	4 412 156.82	106	956 571.12	4 412 289.23	166	957 155.71	4 413 179.52
47	956 009.96	4 412 155.85	107	956 580.92	4 412 291.58	167	957 136.59	4 413 190.9
48	956 025.55	4 412 146.82	108	956 587.99	4 412 294.05	168	957 138.36	4 413 192.13
49	956 049.64	4 412 153.55	109	956 648.22	4 412 337.2	169	957 078.76	4 413 228.57
50	956 052.2	4 412 135.88	110	956 528.72	4 412 353.67	170	957 078.46	4 413 225.6
51	956 053.25	4 412 129.61	111	956 528.89	4 412 352.56	171	957 048	4 413 250.45
52	956 003.99	4 412 115.54	112	956 524.39	4 412 351.44	172	957 043.83	4 413 249.91
53	956 004.56	4 412 113.6	113	956 524.27	4 412 351.92	173	956 952.23	4 413 306.02
54	956 235.28	4 412 178.41	114	956 523.79	4 412 351.73	174	956 805.67	4 413 621.74
55	956 232.11	4 412 179.66	115	956 529.95	4 412 343.32	175	956 805.82	4 413 623.42
56	956 071.34	4 412 134	116	956 535.95	4 412 347.29	176	956 803.31	4 413 618.4
57	956 072.01	4 412 129.96	117	956 537.09	4 412 345.41	177	956 888.3	4 413 435.42

Перечень координат поворотных точек
земельного участка 86:11:0902001:3У1

Номер	X	Y
181	956 810.21	4 413 635.71
182	956 810.84	4 413 633.49
183	956 809.26	4 413 630.33
184	956 812.47	4 413 633.78
185	956 794.99	4 413 641.17
186	956 799.73	4 413 643.7
187	956 793.82	4 413 647.1
188	956 711.91	4 413 823.44
189	956 630.9	4 413 997.85
190	956 627.22	4 413 997.69
191	956 709.75	4 413 819.85
192	956 791.83	4 413 643.15
193	956 733.49	4 413 718.14
194	956 728.82	4 413 728.72
195	956 710.06	4 413 718.54
196	956 133.4	4 415 767.21
197	956 133.49	4 415 770.34
198	955 972.86	4 415 864.26
199	955 818.21	4 416 012.17
200	955 784.37	4 416 031.96
201	955 778.01	4 416 037.56
202	955 770.27	4 416 058.04
203	955 775.58	4 416 031.78
204	955 816.99	4 416 007.61
205	955 960.43	4 415 870.41
206	955 970.01	4 415 862.51
207	955 706.83	4 416 222.8
208	955 687.59	4 416 288.24
209	955 682.24	4 416 289.1
210	955 698.51	4 416 236.8
211	955 686.97	4 416 290.36
212	955 684.97	4 416 297.16
213	955 679.58	4 416 297.65
214	955 681.58	4 416 291.23
215	955 682.31	4 416 305.73
216	955 664.07	4 416 364.61
217	955 659.37	4 416 362.83
218	955 676.92	4 416 306.2
219	955 648.35	4 416 378.02
220	955 654.87	4 416 389.7
221	955 645.99	4 416 385.65
222	955 669.16	4 416 398.22
223	955 664.82	4 416 394.24
224	955 675.02	4 416 386.96
225	955 675.64	4 416 391.96
226	955 645.24	4 416 388.06
227	955 655.51	4 416 392.77
228	955 651.13	4 416 406.07
229	955 640.89	4 416 402.12
230	955 663.68	4 416 396.51
231	955 666.66	4 416 397.87
232	955 662.19	4 416 410.34
233	955 659.51	4 416 409.3
234	955 659.81	4 416 429.56
235	955 653.39	4 416 430.64
236	955 636.65	4 416 453.29
237	955 634.94	4 416 455.22

Перечень координат поворотных точек земельного участка 86:11:0903001:414:3У1

Номер	X	Y	Номер	X	Y
1	955 333.1	4 417 227.57	61	955 142.1	4 418 060.24
2	955 326.79	4 417 248.93	62	955 103.33	4 418 274.84
3	955 323.99	4 417 250.03	63	955 090.7	4 418 268.8
4	955 315.81	4 417 249.86	64	955 097.85	4 418 233.57
5	955 315.67	4 417 252.66	65	955 098.94	4 418 234.45
6	955 324.46	4 417 253.07	66	955 100.07	4 418 250.77
7	955 325.71	4 417 252.6	67	955 106.49	4 418 253.54
8	955 323.65	4 417 259.58	68	955 105.44	4 418 239.73
9	955 321.61	4 417 259.66	69	955 110.12	4 418 243.52
10	955 323.27	4 417 255.79	70	955 105.64	4 418 265.81
11	955 324.47	4 417 256.41	71	955 101.88	4 418 263.97
12	955 324.81	4 417 255.39	72	955 101.88	4 418 264
13	955 322.73	4 417 254.49	73	955 101.88	4 418 263.99
14	955 320.51	4 417 259.71	74	955 043.21	4 418 529.41
15	955 295.54	4 417 260.8	75	955 041.04	4 418 513.64
16	955 290.33	4 417 259.01	76	955 090.29	4 418 270.82
17	955 290.98	4 417 256.76	77	955 103.32	4 418 277.07
18	955 282.77	4 417 254.21	78	955 100.8	4 418 289.48
19	955 283.57	4 417 254.26	79	955 056.46	4 418 508.07
20	955 297.78	4 417 253.88	80	955 056.22	4 418 521.24
21	955 297.54	4 417 261.83	81	955 054.39	4 418 525.24
22	955 301.17	4 417 252.01	82	955 047.05	4 418 517.2
23	955 301.22	4 417 249.02	83	955 045.84	4 418 508.52
24	955 298.75	4 417 248.9	84	955 047.64	4 418 499.93
25	955 296.82	4 417 247.18	85	955 050.56	4 418 500.55
26	955 297.44	4 417 246.46	86	955 048.89	4 418 508.61
27	955 295.42	4 417 244.83	87	955 050.02	4 418 516.78
28	955 305.87	4 417 231.7	88	955 086.48	4 418 326.78
29	955 321.05	4 417 232.32	89	955 084.23	4 418 326.31
30	955 293.57	4 417 254.26	90	955 084.69	4 418 324.15
31	955 300.81	4 417 255.93	91	955 086.93	4 418 324.83
32	955 300.14	4 417 258.85	92	955 066.94	4 418 420.83
33	955 292.9	4 417 257.18	93	955 064.67	4 418 420.4
34	955 297.54	4 417 251.83	94	955 065.07	4 418 418.23
35	955 295.52	4 417 250.27	95	955 067.32	4 418 418.67
36	955 294.67	4 417 249.86	96	955 084.11	4 418 337.29
37	955 294.84	4 417 249.45	97	955 081.84	4 418 336.86
38	955 113.14	4 418 228.63	98	955 082.24	4 418 334.69
39	955 104.06	4 418 221.44	99	955 084.49	4 418 335.14
40	955 103.34	4 418 211.96	100	955 067.97	4 418 415.42
41	955 104.21	4 418 202.23	101	955 065.73	4 418 414.94
42	955 145.71	4 417 997.65	102	955 066.18	4 418 412.79
43	955 184.24	4 417 844.04	103	955 068.43	4 418 413.26
44	955 160.49	4 417 996.33	104	955 069.61	4 418 721.03
45	955 159.37	4 418 000.75	105	955 047.5	4 418 560.54
46	955 123.56	4 418 149.09	106	955 060.91	4 418 555.37
47	955 121.31	4 418 148.62	107	955 076.3	4 418 667
48	955 121.76	4 418 146.47	108	955 073.57	4 418 689.08
49	955 124.01	4 418 146.95	109	955 071.31	4 418 671.55
50	955 159.7	4 417 978.04	110	955 070.31	4 418 664.26
51	955 156.76	4 417 977.43	111	955 069	4 418 654.73
52	955 158.41	4 417 970.52	112	955 066.04	4 418 655.15
53	955 161.36	4 417 970.98	113	955 067.34	4 418 664.64
54	955 125.11	4 418 141.12	114	955 068.33	4 418 671.93
55	955 122.84	4 418 140.89	115	955 072.12	4 418 700.78
56	955 123.24	4 418 138.52	116	955 069.69	4 418 614.06
57	955 125.49	4 418 138.96	117	955 055.78	4 418 581.02

Перечень координат поворотных точек земельного участка 86-11-0903001:414:3/1

Номер	X	Y	Номер	X	Y
121	955 057.34	4 418 570.45	180	954 989.25	4 418 932.5
122	955 058.73	4 418 580.62	181	954 989.58	4 418 930.33
123	955 062.97	4 418 613.69	182	954 991.85	4 418 930.66
124	954 957.84	4 419 243.13	183	954 960.4	4 419 516.22
125	954 958.06	4 419 076.3	184	954 959.93	4 419 304.27
126	954 961.06	4 419 076.31	185	954 957.75	4 419 304.24
127	954 967.86	4 419 030.1	186	954 957.82	4 419 253.00
128	954 968.64	4 419 030.19	187	954 981.1	4 419 219.63
129	954 970	4 419 021.05	188	954 980.94	4 419 304.28
130	954 971.45	4 419 011.34	189	954 977.93	4 419 304.27
131	954 972.17	4 419 006.54	190	954 978.4	4 419 517.99
132	954 973.17	4 419 006.45	191	954 970.33	4 419 432.27
133	954 972.29	4 419 005.7	192	954 968.03	4 419 432.27
134	954 973.96	4 418 984.56	193	954 968.03	4 419 430.08
135	954 975.38	4 418 985.09	194	954 970.32	4 419 430.08
136	954 993.68	4 418 862.72	195	954 970.27	4 419 256.87
137	955 064.21	4 418 766.59	196	954 967.96	4 419 256.87
138	955 060.91	4 418 794.75	197	954 967.98	4 419 254.67
139	955 007.01	4 418 868.21	198	954 970.27	4 419 254.67
140	954 989.32	4 418 886.44	199	954 970.3	4 419 343.57
141	954 989.33	4 418 986.43	200	954 966	4 419 343.57
142	954 987.3	4 419 000.02	201	954 966	4 419 341.39
143	954 979.79	4 419 002.25	202	954 970.3	4 419 341.38
144	954 980.63	4 419 005.12	203	954 960.41	4 419 518.23
145	954 986.81	4 419 003.29	204	954 978.4	4 419 519.99
146	954 986.26	4 419 006.98	205	954 978.54	4 419 583.46
147	954 984.29	4 419 006.77	206	954 974.33	4 419 604.25
148	954 984.04	4 419 009.51	207	954 967.17	4 419 639.57
149	954 982.06	4 419 010.95	208	954 950.74	4 419 632.84
150	954 981.87	4 419 012.35	209	954 957.36	4 419 603.41
151	954 976.65	4 419 012.1	210	954 957.37	4 419 597.37
152	954 976.29	4 419 018.9	211	954 960.55	4 419 581.08
153	954 985.6	4 419 019.36	212	954 968.86	4 419 614.59
154	954 984.85	4 419 024.41	213	954 965.9	4 419 613.87
155	954 987.73	4 419 031.13	214	954 967.71	4 419 605.66
156	954 987.32	4 419 033.76	215	954 967.75	4 419 597.21
157	954 981.36	4 419 077.94	216	954 970.73	4 419 597.35
158	954 981.09	4 419 208.67	217	954 970.67	4 419 606.21
159	954 970.25	4 419 166.16	218	954 968.06	4 419 520.97
160	954 967.95	4 419 166.16	219	954 968.05	4 419 516.98
161	954 967.95	4 419 163.98	220	954 970.35	4 419 519.2
162	954 970.25	4 419 163.97	221	954 970.35	4 419 520.96
163	955 041.19	4 418 811.79			
164	955 039.33	4 418 810.44			
165	955 040.63	4 418 808.67			
166	955 042.49	4 418 810.02			
167	954 970.53	4 419 084.87			
168	954 967.53	4 419 084.86			
169	954 967.57	4 419 076.37			
170	954 968.78	4 419 067.74			
171	954 971.74	4 419 068.16			
172	954 970.57	4 419 076.49			
173	955 000.62	4 418 874.15			
174	954 997.65	4 418 873.73			
175	954 998.93	4 418 865.11			
176	955 004.27	4 418 857.76			

Перечень координат поворотных точек земельного участка 86-11-0401001:1005:3/1

Номер	X	Y
1	954 383.2	4 423 547.22
2	954 371.53	4 423 737.24
3	954 370.56	4 423 737.14
4	954 370.4	4 423 739.36
5	954 371.37	4 423 739.44
6	954 355.55	4 423 997.43
7	954 327.48	4 424 267.61
8	954 268.02	4 425 216.15
9	954 249.48	4 425 226.51
10	954 271.29	4 424 877.78
11	954 272.2	4 424 877.84
12	954 277.68	4 424 790.48
13	954 288.62	4 424 615.79
14	954 299.57	4 424 441.09
15	954 309.43	4 424 284.07
16	954 308.46	4 424 283.33
17	954 308.77	4 424 278.41
18	954 293.74	4 424 277.69
19	954 295.51	4 424 267.64
20	954 311.33	4 424 258.5
21	954 319.54	4 424 178.02
22	954 335.66	4 424 020.19
23	954 334.74	4 424 020.1
24	954 264.84	4 425 141.54
25	954 262.54	4 425 141.39
26	954 262.68	4 425 139.19
27	954 264.98	4 425 139.34
28	954 364.52	4 423 827.72
29	954 362.23	4 423 827.5
30	954 362.45	4 423 825.3
31	954 364.75	4 423 825.52
32	954 268.02	4 425 054.05
33	954 268.01	4 425 054.05
34	954 268.15	4 425 051.85
35	954 270.45	4 425 052
36	954 270.31	4 425 054.2
37	954 268.02	4 425 054.06
38	954 355.52	4 423 915.88
39	954 353.23	4 423 915.65
40	954 355.45	4 423 913.46
41	954 355.74	4 423 913.68
42	954 275.78	4 424 966.85
43	954 273.49	4 424 966.7
44	954 273.63	4 424 964.51
45	954 275.93	4 424 964.68
46	954 346.52	4 424 003.88
47	954 344.24	4 424 003.65
48	954 344.46	4 424 001.46
49	954 346.74	4 424 001.69
50	954 281.26	4 424 879.51
51	954 278.96	4 424 879.36
52	954 279.1	4 424 877.16
53	954 281.4	4 424 877.31
54	954 337.53	4 424 091.96
55	954 335.24	4 424 091.73
56	954 335.48	4 424 089.53

Перечень координат поворотных точек земельного участка 86-11-0401001-1005-3V1

Номер	X	Y	Номер	X	Y
60	954 284.57	4 424 789.82	120	954 266.83	4 424 285.52
61	954 285.88	4 424 789.96	121	954 249.89	4 424 264.73
62	954 328.53	4 424 180.04	122	954 250.04	4 424 261.76
63	954 326.24	4 424 179.81	123	954 266.98	4 424 262.53
64	954 326.47	4 424 177.62	124	954 946.7	4 419 650.84
65	954 328.75	4 424 177.84	125	954 955.09	4 419 654.2
66	954 292.21	4 424 704.81	126	954 966.45	4 419 658.3
67	954 289.91	4 424 704.66	127	954 950.28	4 419 742.74
68	954 290.05	4 424 702.47	128	954 947.28	4 419 742.45
69	954 292.35	4 424 702.61	129	954 941.34	4 419 771.32
70	954 319.87	4 424 270.18	130	954 935.84	4 419 833.91
71	954 315.2	4 424 269.92	131	954 919.8	4 419 823.11
72	954 315.57	4 424 263.67	132	954 924.33	4 419 771.84
73	954 320.24	4 424 263.96	133	954 923.25	4 419 771.6
74	954 297.69	4 424 617.46	134	954 923.5	4 419 768.71
75	954 295.39	4 424 617.31	135	954 929.61	4 419 739.05
76	954 295.52	4 424 615.12	136	954 927.01	4 419 738.58
77	954 297.82	4 424 615.27	137	954 933.15	4 419 778.6
78	954 311.82	4 424 355.28	138	954 930.17	4 419 778.46
79	954 311.95	4 424 353.09	139	954 930.91	4 419 770.05
80	954 314.25	4 424 353.24	140	954 932.82	4 419 761.28
81	954 314.12	4 424 355.42	141	954 935.78	4 419 761.99
82	954 303.17	4 424 530.12	142	954 933.89	4 419 770.19
83	954 308.86	4 424 529.97	143	954 952.89	4 419 683.97
84	954 308.99	4 424 527.77	144	954 950.65	4 419 683.46
85	954 303.31	4 424 527.92	145	954 951.12	4 419 681.33
86	954 308.65	4 424 442.78	146	954 953.36	4 419 681.82
87	954 306.34	4 424 442.63	147	954 917.08	4 419 853.9
88	954 306.48	4 424 440.43	148	954 923.15	4 419 858.11
89	954 308.78	4 424 440.57	149	954 922.45	4 419 866.36
90	954 212.51	4 424 264.58	150	954 916.79	4 419 929.26
91	954 215.73	4 424 264.73	151	954 915.37	4 419 946.18
92	954 215.8	4 424 263.48	152	954 918.36	4 419 946.46
93	954 221.45	4 424 263.73	153	954 919.79	4 419 929.5
94	954 221.66	4 424 280.48	154	954 925.44	4 419 866.63
95	954 214.69	4 424 260.15	155	954 925.99	4 419 860.08
96	954 215.17	4 424 259.74	156	954 933.1	4 419 865
97	954 217.58	4 424 260.29	157	954 898.87	4 420 254.29
98	954 218.5	4 424 256.53	158	954 884.38	4 420 309.89
99	954 225.54	4 424 256.47	159	954 873.38	4 420 350.41
100	954 225.52	4 424 253.48	160	954 880.29	4 420 272.02
101	954 219.22	4 424 253.52	161	954 895.86	4 420 096.68
102	954 219.3	4 424 253.21	162	954 910.85	4 419 826.64
103	954 217.07	4 424 252.55	163	954 886.96	4 420 273.7
104	954 217.45	4 424 249.85	164	954 887.17	4 420 271.52
105	954 238.96	4 424 252.89	165	954 889.45	4 420 271.72
106	954 239.14	4 424 255.89	166	954 889.26	4 420 273.91
107	954 245.6	4 424 255.49	167	954 914.54	4 419 988.4
108	954 249.73	4 424 259.59	168	954 912.25	4 419 988.19
109	954 250.95	4 424 260.33	169	954 912.44	4 419 986.01
110	954 251.9	4 424 259.89	170	954 914.73	4 419 986.21
111	954 253.79	4 424 261.39	171	954 902.19	4 420 096.42
112	954 256.59	4 424 261.11	172	954 902.73	4 420 095.03
113	954 262.33	4 424 259.03	173	954 905.02	4 420 095.22
114	954 268.37	4 424 258.79	174	954 905.18	4 420 096.68
115	954 269.7	4 424 258.73	175	954 903.75	4 420 113.64
116	954 286.28	4 424 262.78	176	954 897.74	4 420 180.72
			177	954 896.31	4 420 197.68

Перечень координат поворотных точек земельного участка 86-11-0901001-161-3V1

Номер	X	Y
1	955 712.09	4 409 705.67
2	955 731.18	4 409 714.2
3	955 729.48	4 409 755.28
4	955 726.26	4 409 833
5	955 764.33	4 410 056.9
6	955 764.34	4 410 056.9
7	955 764.34	4 410 056.9
8	955 765.6	4 410 064.34
9	955 781.97	4 410 071.5
10	955 779.82	4 410 089.71
11	955 743.28	4 410 079.31
12	955 742.38	4 410 074.04
13	955 701.86	4 409 834.44
14	955 707.77	4 409 795.86
15	955 762.32	4 410 075.78
16	955 753.36	4 410 072.92
17	955 751.75	4 410 063.65
18	955 754.72	4 410 063.15
19	955 756	4 410 070.62
20	955 763.23	4 410 072.92
21	955 717.32	4 409 747.94
22	955 719.62	4 409 748.04
23	955 719.52	4 409 750.24
24	955 717.22	4 409 750.13
25	955 739.86	4 409 901.19
26	955 742.12	4 409 990.79
27	955 742.12	4 409 990.8
28	955 742.13	4 409 890.8
29	955 742.52	4 409 992.96
30	955 740.26	4 409 993.37
31	955 714.16	4 409 842.36
32	955 712.71	4 409 833.82
33	955 713.14	4 409 825.16
34	955 716.14	4 409 825.31
35	955 715.72	4 409 833.64
36	955 717.11	4 409 841.86
37	955 726.41	4 409 912.02
38	955 728.67	4 409 911.59
39	955 729.06	4 409 913.77
40	955 726.8	4 409 914.16
41	955 831.58	4 410 042.35
42	955 831.91	4 410 042.95
43	955 830.37	4 410 046.98
44	955 828.42	4 410 048.03
45	955 829.48	4 410 050.06
46	955 835.76	4 410 047.23
47	955 836.36	4 410 048.75
48	955 830.54	4 410 051.53
49	955 827.7	4 410 052.42
50	955 828.6	4 410 055.29
51	955 831.63	4 410 054.34
52	955 833.91	4 410 053.24
53	955 834.6	4 410 054.6
54	955 836.36	4 410 052.76
55	955 838.57	4 410 060.37
56	955 827.81	4 410 064.42
57	955 821.53	4 410 128.81

Перечень координат поворотных точек земельного участка 86:11:0901001:161:3У1

Номер	X	Y	Номер	X	Y	Номер	X	Y
60	955 801.64	4 410 226.76	120	955 789.85	4 410 092.65	180	955 582.48	4 410 810.4
61	955 798.85	4 410 226.38	121	955 780.83	4 410 090	181	955 582.28	4 410 801.75
62	955 798.22	4 410 229.78	122	955 797.46	4 410 075.82	182	955 584.28	4 410 789.27
63	955 797.44	4 410 233.15	123	955 802.44	4 410 077.38	183	955 588.23	4 410 789.48
64	955 799.73	4 410 233.68	124	955 799.16	4 410 095.38	184	955 598.39	4 410 889.33
65	955 798.73	4 410 236.85	125	955 795.52	4 410 094.31	185	955 591.54	4 410 688.64
66	955 787.76	4 410 313.53	126	955 673.3	4 410 563.01	186	955 593.6	4 410 667.85
67	955 778.82	4 410 390.16	127	955 689.52	4 410 575.92	187	955 603.99	4 410 652.14
68	955 768.07	4 410 473.17	128	955 673.04	4 410 600.25	188	955 629.56	4 410 613.54
69	955 712.54	4 410 541.22	129	955 658.06	4 410 585.78	189	955 642.99	4 410 610.03
70	955 696.13	4 410 531.27	130	955 676.21	4 410 571.02	190	955 656.01	4 410 622.63
71	955 695.16	4 410 530.31	131	955 677.42	4 410 569.19	191	955 649.67	4 410 629.69
72	955 738.88	4 410 464.95	132	955 679.34	4 410 570.47	192	955 639.21	4 410 649.83
73	955 791.81	4 410 228.67	133	955 678.13	4 410 572.29	193	955 629.31	4 410 664.73
74	955 807.89	4 410 101.18	134	955 678.12	4 410 572.29	194	955 617.81	4 410 679.77
75	955 806.88	4 410 100.86	135	955 678.12	4 410 572.29	195	955 615.85	4 410 686.77
76	955 807.27	4 410 097.76	136	955 610.43	4 411 119.6	196	955 614.23	4 410 733.09
77	955 800.16	4 410 095.88	137	955 610.6	4 411 130.32	197	955 612.47	4 410 784.61
78	955 803.46	4 410 077.7	138	955 610.22	4 411 140.12	198	955 609.55	4 410 831.01
79	955 807.49	4 410 078.96	139	955 605.57	4 411 140.14	199	955 609.39	4 410 833.35
80	955 808.36	4 410 068.98	140	955 605.26	4 411 203.5	200	955 608.35	4 410 852.09
81	955 809.7	4 410 067.29	141	955 601.54	4 411 205.87	201	955 607.77	4 410 879.19
82	955 810.01	4 410 052.88	142	955 600.25	4 411 206.7	202	955 607.53	4 410 890.83
83	955 820.02	4 410 046.1	143	955 592.71	4 411 206.46	203	955 608.43	4 410 980.45
84	955 712.44	4 410 521.01	144	955 588.82	4 411 205.43	204	955 609.89	4 411 084.35
85	955 712.43	4 410 521.01	145	955 587.97	4 411 204.96	205	955 595.59	4 411 158.22
86	955 710.53	4 410 519.73	146	955 587.57	4 411 140.28	206	955 595.58	4 411 156.01
87	955 711.75	4 410 517.9	147	955 580.3	4 411 140.3	207	955 597.88	4 411 156.01
88	955 713.66	4 410 519.18	148	955 580.54	4 411 113.48	208	955 597.88	4 411 156.02
89	955 712.43	4 410 521	149	955 583.16	4 411 089.14	209	955 597.88	4 411 156.03
90	955 819.23	4 410 065.59	150	955 583.64	4 411 061.53	210	955 597.9	4 411 158.2
91	955 816.23	4 410 065.53	151	955 584.86	4 411 061.6	211	955 641.08	4 410 812.94
92	955 816.45	4 410 055.96	152	955 585.06	4 411 058.61	212	955 640.54	4 410 813.48
93	955 825.58	4 410 053.09	153	955 583.64	4 411 058.51	213	955 638.66	4 410 811.78
94	955 826.48	4 410 055.96	154	955 582.98	4 411 040.84	214	955 639.18	4 410 811.26
95	955 819.39	4 410 058.18	155	955 582.56	4 411 029.26	215	955 595.32	4 411 108.96
96	955 742.87	4 410 476.1	156	955 582.45	4 411 009.38	216	955 581.88	4 411 108.86
97	955 740.36	4 410 474.42	157	955 584.68	4 411 009.5	217	955 581.76	4 411 105.86
98	955 744.96	4 410 467.59	158	955 584.83	4 411 006.5	218	955 585.4	4 411 105.96
99	955 748.76	4 410 459.57	159	955 582.44	4 411 006.37	219	955 640.41	4 410 828.65
100	955 749.68	4 410 460.23	160	955 682.24	4 410 965.75	220	955 638.49	4 410 827.37
101	955 747.75	4 410 468.81	161	955 581.8	4 410 936.15	221	955 639.72	4 410 825.55
102	955 818.02	4 410 094.78	162	955 584.53	4 410 935.98	222	955 641.63	4 410 826.83
103	955 813.66	4 410 094.23	163	955 584.34	4 410 932.98	223	955 597.37	4 411 073.81
104	955 814.07	4 410 088.37	164	955 581.75	4 410 933.13	224	955 595.08	4 411 073.81
105	955 818.5	4 410 088.47	165	955 581.12	4 410 890.64	225	955 595.06	4 411 071.61
106	955 785.09	4 410 390.04	166	955 581.39	4 410 872.71	226	955 597.37	4 411 071.61
107	955 782.84	4 410 389.55	167	955 584.42	4 410 872.32	227	955 609.73	4 410 681.98
108	955 763.32	4 410 387.39	168	955 584.03	4 410 869.33	228	955 606.74	4 410 681.68
109	955 765.57	4 410 387.91	169	955 581.45	4 410 869.66	229	955 607.61	4 410 672.88
110	955 806.12	4 410 170.32	170	955 581.48	4 410 867.81	230	955 612.56	4 410 665.48
111	955 806.39	4 410 168.15	171	955 582.18	4 410 860.1	231	955 615.06	4 410 667.14
112	955 808.67	4 410 168.43	172	955 583.68	4 410 851.61	232	955 610.53	4 410 673.9
113	955 808.39	4 410 170.81	173	955 588.36	4 410 842.33	233	955 594.57	4 410 989.41
114	955 782.85	4 410 310.71	174	955 591.4	4 410 832.71	234	955 594.55	4 410 987.22
115	955 780.61	4 410 310.21	175	955 583.58	4 410 817.88	235	955 596.85	4 410 987.21
116	955 781.09	4 410 308.06	176	955 583.15	4 410 814.44	236	955 596.87	4 410 989.41

Номер	X	Y	Номер	X	Y	Номер	X	Y
240	955 600.85	4 410 747.41	300	955 598.18	4 411 215.8	360	955 613.99	4 411 451.6
241	955 593.57	4 410 895.47	301	955 600.02	4 411 213.59	361	955 611.75	4 411 452.14
242	955 596.56	4 410 895.44	302	955 602.51	4 411 211.25	362	955 629.89	4 411 511.09
243	955 596.6	4 410 900.59	303	955 605.99	4 411 208.98	363	955 624.03	4 411 504.28
244	955 596.66	4 410 907.39	304	955 595.77	4 411 308.24	364	955 621.94	4 411 495.68
245	955 596.7	4 410 912.44	305	955 598.43	4 411 301.06	365	955 624.86	4 411 494.98
246	955 593.7	4 410 912.48	306	955 601.24	4 411 302.09	366	955 626.79	4 411 502.9
247	955 593.66	4 410 907.4	307	955 598.39	4 411 309.81	367	955 632	4 411 509.17
248	955 593.6	4 410 900.58	308	955 598.45	4 411 318.04	368	955 588.41	4 411 380.01
249	955 583.6	4 410 807.78	309	955 595.46	4 411 318.05	369	955 589.09	4 411 381.12
250	955 583.58	4 410 806.77	310	955 595.38	4 411 309.28	370	955 593	4 411 388.31
251	955 584.58	4 410 806.76	311	955 595.65	4 411 308.55	371	955 595.74	4 411 394.79
252	955 584.6	4 410 807.77	312	955 614.17	4 411 239.31	372	955 597.74	4 411 401.4
253	955 593.18	4 410 828.05	313	955 607.58	4 411 236.1	373	955 598.73	4 411 406.13
254	955 593.16	4 410 823.04	314	955 608.89	4 411 233.41	374	955 598.73	4 411 410.51
255	955 593.13	4 410 819.53	315	955 614.66	4 411 236.2	375	955 597.38	4 411 417.37
256	955 593.49	4 410 815.86	316	955 615.13	4 411 237.33	376	955 595.03	4 411 432.52
257	955 593.97	4 410 810.95	317	955 588	4 411 210.39	377	955 609.97	4 411 504.64
258	955 596.96	4 410 811.25	318	955 594.78	4 411 211.89	378	955 676.82	4 411 578.37
259	955 596.48	4 410 816.16	319	955 588.93	4 411 219.03	379	955 696.72	4 411 592.38
260	955 596.14	4 410 819.58	320	955 588.31	4 411 220.17	380	955 696.73	4 411 592.39
261	955 596.15	4 410 823.02	321	955 588.26	4 411 358.83	381	955 696.74	4 411 592.4
262	955 596.19	4 410 828.04	322	955 606.29	4 411 364.84	382	955 697.48	4 411 592.58
263	955 607.4	4 411 218.96	323	955 606.45	4 411 387.64	383	955 694.31	4 411 595.07
264	955 612.48	4 411 231	324	955 633.7	4 411 499.37	384	955 701.52	4 411 603.82
265	955 619.47	4 411 247.66	325	955 649.61	4 411 518.64	385	955 706.48	4 411 599.63
266	955 624.75	4 411 260.22	326	955 653.46	4 411 515.43	386	955 701.43	4 411 593.6
267	955 605.91	4 411 311.08	327	955 717.3	4 411 592.13	387	955 701.84	4 411 593.7
268	955 606.25	4 411 357.94	328	955 709.14	4 411 580.46	388	955 704.27	4 411 594.35
269	955 595.72	4 411 354.81	329	955 706.81	4 411 589.83	389	955 720.1	4 411 597.78
270	955 588.57	4 411 352	330	955 706.81	4 411 588.99	390	955 744.2	4 411 628.78
271	955 587.9	4 411 307.92	331	955 705.81	4 411 588.99	391	955 743.89	4 411 638.65
272	955 589.51	4 411 278.91	332	955 705.81	4 411 589.56	392	955 743.42	4 411 642.65
273	955 603.24	4 411 276.56	333	955 699.24	4 411 587.76	393	955 742.4	4 411 655.77
274	955 605.39	4 411 274.23	334	955 680.04	4 411 574.5	394	955 742.66	4 411 658.68
275	955 606.16	4 411 270.18	335	955 683.32	4 411 560.82	395	955 697.66	4 411 604.47
276	955 609.13	4 411 267.88	336	955 633.15	4 411 527.81	396	955 693.82	4 411 607.67
277	955 611.14	4 411 265	337	955 626.97	4 411 516.28	397	955 728.61	4 411 629.38
278	955 612.2	4 411 255.88	338	955 620.23	4 411 496.03	398	955 727.19	4 411 627.68
279	955 612.2	4 411 255.87	339	955 618.05	4 411 471.67	399	955 728.96	4 411 626.21
280	955 612.2	4 411 254.98	340	955 602.39	4 411 442.38	400	955 730.38	4 411 627.91
281	955 614.04	4 411 258.91	341	955 600.84	4 411 437.74	401	955 749.19	4 411 638.35
282	955 611.29	4 411 266.3	342	955 600.07	4 411 432.63	402	955 785.4	4 411 681.95
283	955 614.12	4 411 267.35	343	955 602.25	4 411 418.43	403	955 792.8	4 411 675.85
284	955 617.29	4 411 258.77	344	955 603.73	4 411 411.12	404	955 794.26	4 411 677.63
285	955 613.41	4 411 250.51	345	955 603.74	4 411 406.53	405	955 790.91	4 411 681.23
286	955 612.19	4 411 251.08	346	955 602.61	4 411 400.17	406	955 792.56	4 411 683.22
287	955 612.17	4 411 244.96	347	955 600.45	4 411 393.08	407	955 775.57	4 411 698.28
288	955 606.96	4 411 249.84	348	955 599.53	4 411 390.9	408	955 748.38	4 411 685.55
289	955 601.14	4 411 249.12	349	955 598.97	4 411 388.63	409	955 747.44	4 411 655.75
290	955 591.24	4 411 228.06	350	955 598.96	4 411 385.3	410	955 748.63	4 411 643.83
291	955 591.78	4 411 228.32	351	955 597.07	4 411 385.31	411	955 780.23	4 411 681.53
292	955 593.05	4 411 225.6	352	955 593.95	4 411 379.49	412	955 778.83	4 411 689.84
293	955 591.42	4 411 224.81	353	955 588.33	4 411 370.38	413	955 780.58	4 411 688.36
294	955 593.1	4 411 221.88	354	955 671.44	4 411 585.14	414	955 792	4 411 690.06
295	955 595.77	4 411 218.69	355	955 677.6	4 411 560.04			
296	955 585.81	4 411 220.23	356	955 682.73	4 411 566.25			

Номер	X	Y	Номер	X	Y	Номер	X	Y
1	955 872.96	4 411 896.62	61	955 934.41	4 412 053.44	121	956 411.54	4 412 261.81
2	955 878.84	4 411 919.43	62	955 934.18	4 412 052.31	122	956 413.37	4 412 263.04
3	955 863.11	4 411 930.47	63	955 933.3	4 412 051.4	123	956 412.09	4 412 264.95
4	955 861.66	4 411 919.63	64	955 931.77	4 412 049.82	124	956 410.26	4 412 263.72
5	955 860.02	4 411 910.01	65	955 920.39	4 412 053.3	125	956 253.05	4 412 197.56
6	955 858.8	4 411 902.87	66	955 921.54	4 412 056.56	126	956 255.17	4 412 198.16
7	955 855.85	4 411 903.37	67	955 920.89	4 412 056.82	127	956 254.54	4 412 200.37
8	955 857.07	4 411 910.54	68	955 921.22	4 412 057.74	128	956 252.42	4 412 199.77
9	955 858.7	4 411 920.14	69	955 917.53	4 412 056.83	129	956 367.35	4 412 235.42
10	955 861.06	4 411 932.12	70	955 869.38	4 412 007.08	130	956 360.48	4 412 230.84
11	955 852.2	4 411 939.26	71	955 891.57	4 411 989.72	131	956 352.52	4 412 228.58
12	955 849.43	4 411 939.69	72	955 946.03	4 412 046	132	956 353.34	4 412 225.69
13	955 846.4	4 411 933.9	73	955 959.12	4 412 099.45	133	956 360.72	4 412 227.78
14	955 841.32	4 411 902.09	74	955 990.92	4 412 112.34	134	956 361.02	4 412 227.86
15	955 844.88	4 411 901.43	75	955 953.26	4 412 115.17	135	956 361.78	4 412 228.07
16	955 836.5	4 411 853.8	76	955 944.21	4 412 112.61	136	956 369.02	4 412 232.95
17	955 838.04	4 411 853.51	77	955 942.28	4 412 103.39	137	956 310.19	4 412 216.19
18	955 836.65	4 411 846.04	78	955 945.21	4 412 102.78	138	956 308.08	4 412 215.58
19	955 835	4 411 846.35	79	955 946.77	4 412 110.22	139	956 308.7	4 412 213.37
20	955 833.93	4 411 839.82	80	955 954.07	4 412 112.29	140	956 310.83	4 412 213.98
21	955 833.93	4 411 839.81	81	956 049.64	4 412 153.55	141	956 656.96	4 412 343.19
22	955 833.93	4 411 839.8	82	956 025.55	4 412 146.62	142	956 651.62	4 412 353.75
23	955 833.86	4 411 824.72	83	956 013.54	4 412 143.2	143	956 647.61	4 412 359.12
24	955 828.37	4 411 812.8	84	955 992.91	4 412 139.4	144	956 642.76	4 412 353.79
25	955 816.07	4 411 785.92	85	955 997.44	4 412 130.08	145	956 637.29	4 412 350.44
26	955 851.79	4 411 763.46	86	956 002.9	4 412 118.98	146	956 632.65	4 412 348.31
27	955 852.03	4 411 763.26	87	956 003.99	4 412 115.54	147	956 633.14	4 412 347.55
28	955 852.13	4 411 763.19	88	956 053.25	4 412 129.61	148	956 631.28	4 412 346.36
29	955 852.84	4 411 764.46	89	956 052.2	4 412 135.88	149	956 630.64	4 412 347.37
30	955 847.9	4 411 773.23	90	956 023.31	4 412 134.71	150	956 624.76	4 412 344.67
31	955 868.94	4 411 897.3	91	956 021.19	4 412 134.11	151	956 598.71	4 412 340.95
32	955 844.23	4 411 833.12	92	956 021.83	4 412 131.9	152	956 588.27	4 412 338.53
33	955 843.86	4 411 830.95	93	956 023.94	4 412 132.5	153	956 581.89	4 412 334.1
34	955 846.13	4 411 830.56	94	956 232.11	4 412 179.66	154	956 576.95	4 412 327.18
35	955 846.5	4 411 832.73	95	956 212.49	4 412 199.71	155	956 575.25	4 412 324.62
36	955 866.37	4 411 949.29	96	956 067.66	4 412 158.57	156	956 572.8	4 412 317.57
37	955 864.29	4 411 937.28	97	956 070.51	4 412 138.99	157	956 570.66	4 412 318.09
38	955 875.85	4 411 927.96	98	956 071.34	4 412 134	158	956 563.68	4 412 314.6
39	955 877.91	4 411 940.08	99	956 175.98	4 412 175.67	159	956 559.48	4 412 314.03
40	955 862.23	4 411 938.93	100	956 178.09	4 412 176.28	160	956 555.26	4 412 314.6
41	955 864.32	4 411 950.92	101	956 177.46	4 412 178.49	161	956 538.19	4 412 318.54
42	955 852.89	4 411 960.05	102	956 175.35	4 412 177.88	162	956 549.14	4 412 299.03
43	955 850.44	4 411 945.63	103	956 098.91	4 412 163.79	163	956 551.94	4 412 296.94
44	955 854.71	4 411 944.98	104	956 101.03	4 412 154.38	164	956 571.12	4 412 289.23
45	955 990.15	4 412 114.87	105	956 100.39	4 412 156.6	165	956 572.62	4 412 306.14
46	955 987.29	4 412 122.7	106	956 098.28	4 412 155.99	166	956 573.58	4 412 311.08
47	955 982.19	4 412 135	107	956 214.66	4 412 200.33	167	956 566.83	4 412 312.36
48	955 980.59	4 412 134.55	108	956 234.29	4 412 180.28	168	956 565.24	4 412 308.01
49	955 950.61	4 412 126.23	109	956 244.06	4 412 183.05	169	956 565.42	4 412 328.21
50	955 946.76	4 412 123.79	110	956 224.92	4 412 203.24	170	956 532	4 412 342.03
51	955 937.01	4 412 105.92	111	956 457.81	4 412 289.49	171	956 519.08	4 412 333.47
52	955 940.58	4 412 102.3	112	956 449.74	4 412 283.59	172	956 557.09	4 412 324.46
53	955 947.51	4 412 091.23	113	956 442.53	4 412 293.43	173	956 563.03	4 412 324.84
54	955 948.17	4 412 087.84	114	956 358.09	4 412 237.03	174	956 677.88	4 412 356.88
55	955 941.12	4 412 076.3	115	956 251.8	4 412 206.67	175	956 700.72	4 412 371.7
56	955 935.7	4 412 068.58	116	956 250.51	4 412 210.51	176	956 788.58	4 412 394.84
57	955 929.57	4 412 059.78	117	956 227.09	4 412 203.86	177	956 787.49	4 412 398.96

Номер	X	Y	Номер	X	Y	Номер	X	Y
181	957 135.83	4 412 489.64	241	956 937.77	4 412 452.85	301	956 865.23	4 413 458.66
182	957 135.98	4 412 501.92	242	957 274.55	4 412 549.08	302	956 863.15	4 413 457.69
183	957 125.6	4 412 499.19	243	957 170.28	4 412 521.76	303	956 901.45	4 413 378.25
184	957 125.48	4 412 499.63	244	957 170.1	4 412 503.1	304	956 903.53	4 413 376.22
185	957 123.17	4 412 498.95	245	957 275.02	4 412 530.61	305	956 902.61	4 413 378.22
186	957 122.62	4 412 501.07	246	957 220.61	4 412 524.47	306	956 900.52	4 413 377.24
187	957 124.93	4 412 501.77	247	957 222.74	4 412 525.04	307	956 790.02	4 413 638.52
188	957 124.85	4 412 502.09	248	957 222.15	4 412 527.25	308	956 621.61	4 413 997.43
189	957 136.02	4 412 505.02	249	957 220.03	4 412 526.7	309	956 605.38	4 413 996.7
190	957 136.11	4 412 512.8	250	957 260.52	4 413 090.4	310	956 633.23	4 413 936.51
191	957 109.79	4 412 505.9	251	957 260.02	4 413 110.63	311	956 707.96	4 413 775.6
192	957 060.05	4 412 492.88	252	957 151.87	4 413 176.85	312	956 729.15	4 413 729.01
193	957 049.4	4 412 490.1	253	957 136.62	4 413 166.26	313	956 728.62	4 413 728.72
194	957 049.67	4 412 489.08	254	957 164.25	4 413 157.35	314	956 733.49	4 413 718.14
195	956 937.1	4 412 458.56	255	957 165.48	4 413 159.31	315	956 710.05	4 413 718.54
196	956 768.31	4 412 415.27	256	957 163.58	4 413 160.45	316	956 712.1	4 413 713.8
197	956 766.89	4 412 420.54	257	957 163.58	4 413 160.46	317	956 723.35	4 413 691.37
198	956 704.34	4 412 403.52	258	957 163.57	4 413 160.46	318	956 747.36	4 413 690.94
199	956 701.86	4 412 401.84	259	957 162.37	4 413 158.51	319	956 774.23	4 413 633.01
200	956 701.17	4 412 402.85	260	957 238.46	4 413 114.65	320	956 774.79	4 413 633
201	956 688.53	4 412 399.45	261	957 237.26	4 413 112.69	321	956 780.03	4 413 634.24
202	956 648.91	4 412 373.65	262	957 239.14	4 413 111.53	322	956 786.66	4 413 636.73
203	956 651.49	4 412 370.59	263	957 240.34	4 413 113.49	323	956 642	4 413 939.35
204	956 654.88	4 412 386.69	264	957 117.72	4 413 177.83	324	956 641.06	4 413 941.35
205	956 660.45	4 412 358.61	265	957 132.93	4 413 186.36	325	956 638.98	4 413 940.39
206	956 665.99	4 412 345.08	266	957 078.08	4 413 221.91	326	956 639.91	4 413 938.39
207	956 666.37	4 412 343.97	267	957 076.18	4 413 203.2	327	956 752.12	4 413 702.13
208	956 673.16	4 412 348.36	268	957 082.55	4 413 210.44	328	956 748.13	4 413 700.28
209	956 670.91	4 412 352.37	269	957 080.99	4 413 207.87	329	956 750.74	4 413 694.65
210	957 065.72	4 412 486.59	270	957 095.49	4 413 199.02	330	956 754.72	4 413 696.5
211	957 066.48	4 412 483.68	271	957 097.05	4 413 201.57	331	956 676.34	4 413 859.94
212	957 082.93	4 412 488	272	957 045.12	4 413 222.28	332	956 677.28	4 413 857.93
213	957 082.16	4 412 490.9	273	957 047.02	4 413 240.9	333	956 679.35	4 413 858.91
214	956 701.67	4 412 391.08	274	956 946.42	4 413 302.44	334	956 678.43	4 413 860.9
215	956 693.21	4 412 388.86	275	956 796.28	4 413 627.47	335	956 714.63	4 413 777.49
216	956 685.83	4 412 384.17	276	956 786.28	4 413 616.74	336	956 716.72	4 413 778.45
217	956 687.44	4 412 381.64	277	956 783.4	4 413 612.12	337	956 715.79	4 413 780.46
218	956 694.43	4 412 386.07	278	956 820.05	4 413 534.26	338	956 713.71	4 413 779.48
219	956 702.42	4 412 388.17	279	956 894.77	4 413 373.35	339	956 669.81	4 413 674.07
220	957 012.29	4 412 472.56	280	956 933.07	4 413 290.87	340	956 672.21	4 413 674.67
221	957 013.05	4 412 469.66	281	956 789.2	4 413 616.93	341	956 676.68	4 413 676.83
222	957 021.28	4 412 471.82	282	956 790.13	4 413 614.93	342	956 678.06	4 413 675.1
223	957 021.29	4 412 471.82	283	956 792.22	4 413 615.91	343	956 674.34	4 413 669.24
224	957 029.51	4 412 473.99	284	956 791.28	4 413 617.9	344	956 675.04	4 413 667.44
225	957 028.74	4 412 476.89	285	957 007.64	4 413 256.27	345	956 675.38	4 413 667.7
226	956 774.84	4 412 407.53	286	957 006.08	4 413 253.71	346	956 682.1	4 413 671.38
227	956 776.97	4 412 408.1	287	957 020.59	4 413 244.85	347	956 682.85	4 413 670.04
228	956 776.38	4 412 410.32	288	957 022.16	4 413 247.41	348	956 707.99	4 413 691.64
229	956 774.26	4 412 409.76	289	956 826.72	4 413 536.14	349	956 717.54	4 413 691.47
230	957 009.49	4 412 471.78	290	956 828.91	4 413 537.1	350	956 714.36	4 413 697.77
231	957 002.67	4 412 469.98	291	956 827.57	4 413 539.1	351	956 705.51	4 413 698.16
232	957 003.43	4 412 467.08	292	956 825.79	4 413 538.13	352	956 698.72	4 413 693.86
233	957 010.25	4 412 468.88	293	956 937.17	4 413 304.63	353	956 697.12	4 413 696.39
234	956 858.71	4 412 429.54	294	956 934.46	4 413 303.36	354	956 704.66	4 413 701.19
235	956 858.13	4 412 431.76	295	956 936.23	4 413 296.22	355	956 712.71	4 413 701.05
236	956 856	4 412 431.2	296	956 945.86	4 413 290.56	356	956 705.12	4 413 716.1
237	956 856.56	4 412 428.98	297	956 947.42	4 413 293.13	357	956 698.04	4 413 712.33

Перечень координат поворотных точек земельного участка 86-11-0907001-573-3V1

Номер	X	Y	Номер	X	Y
361	956 670.26	4 413 680.32	421	956 031.24	4 415 814.61
362	956 668.75	4 413 679.01	422	956 029.73	4 415 812.01
363	956 669.04	4 413 678.56	423	956 044.42	4 415 803.43
364	956 675.08	4 413 682.36	424	956 045.93	4 415 806.02
365	956 676.68	4 413 679.82	425	955 806.64	4 416 002.72
366	956 669.03	4 413 674.99	426	955 805.6	4 416 004.42
367	956 132.61	4 415 740.35	427	955 804.75	4 416 003.89
368	956 133.4	4 415 767.21	428	955 805.78	4 416 002.2
369	955 970.01	4 415 882.51	429	955 965.26	4 415 849.74
370	955 960.43	4 415 870.41	430	955 966.74	4 415 852.35
371	955 957.38	4 415 866.93	431	955 963.8	4 415 854
372	955 811.54	4 416 000.36	432	955 961.2	4 415 856.15
373	955 769.63	4 416 031.55	433	955 959.3	4 415 853.84
374	955 760.95	4 416 054.42	434	955 962.19	4 415 851.54
375	955 770.27	4 416 058.04	435	955 828.16	4 415 969.41
376	955 712.91	4 416 207	436	955 829.68	4 415 971.14
377	955 706.83	4 416 222.8	437	955 828.02	4 415 972.6
378	955 697.51	4 416 219.22	438	955 826.51	4 415 970.87
379	955 675.55	4 416 290.17	439	955 894.91	4 415 910.9
380	955 658.69	4 416 292.87	440	955 896.43	4 415 912.63
381	955 684.28	4 416 214.63	441	955 894.77	4 415 914.08
382	955 678.84	4 416 212.02	442	955 893.26	4 415 912.35
383	955 737.08	4 416 041.03	443	955 674.89	4 416 292.3
384	955 747.87	4 416 049.43	444	955 673.05	4 416 298.24
385	955 757.78	4 416 023.33	445	955 656.45	4 416 299.74
386	955 948.16	4 415 856.4	446	955 657.99	4 416 295.02
387	955 958.25	4 415 846.25	447	955 670.41	4 416 306.77
388	955 955.95	4 415 841.18	448	955 653.83	4 416 360.3
389	956 106.04	4 415 754.73	449	955 638.72	4 416 353.95
390	956 121.18	4 415 746.17	450	955 653.66	4 416 308.25
391	955 670.78	4 416 280.98	451	955 649.09	4 416 350.46
392	955 671.42	4 416 278.88	452	955 651.28	4 416 551.15
393	955 673.63	4 416 279.56	453	955 650.63	4 416 353.25
394	955 672.97	4 416 281.66	454	955 648.43	4 416 352.57
395	956 107.9	4 415 769.78	455	955 636.22	4 416 361.62
396	956 106.39	4 415 767.19	456	955 651.44	4 416 368.03
397	956 121.07	4 415 758.61	457	955 650.65	4 416 370.8
398	956 122.58	4 415 761.19	458	955 644.84	4 416 368.5
399	955 698.55	4 416 191.89	459	955 635.25	4 416 364.57
400	955 701.33	4 416 193.03	460	955 634.68	4 416 368.5
401	955 698.95	4 416 199.51	461	955 644.12	4 416 370.37
402	955 696.09	4 416 198.58	462	955 650.05	4 416 372.52
403	956 067.64	4 415 793.07	463	955 648.35	4 416 378.02
404	956 068.53	4 415 791.05	464	955 645.99	4 416 385.65
405	956 068.47	4 415 790.01	465	955 633.85	4 416 380.11
406	956 069.58	4 415 792.01	466	955 631.42	4 416 379.34
407	955 729.92	4 416 111.51	467	955 630.74	4 416 382.06
408	955 732.06	4 416 112.35	468	955 633.01	4 416 382.46
409	955 731.26	4 416 114.4	469	955 645.24	4 416 388.06
410	955 729.12	4 416 113.57	470	955 640.89	4 416 402.12
411	956 053.68	4 415 801.6	471	955 627.01	4 416 396.76
412	956 052.2	4 415 799	472	955 628.71	4 416 393.97
413	956 058.25	4 415 795.52	473	955 628.69	4 416 393.47
414	956 059.75	4 415 798.11	474	955 629.21	4 416 393.45
415	955 769.05	4 416 020.75	475	955 629.23	4 416 393.95
416	955 771.03	4 416 023.01	476	955 620.82	4 416 418.01
417	955 764.93	4 416 028.36	477	955 627.08	4 416 420.43

Перечень координат поворотных точек земельного участка 86-04-0000001-109987-3V2

Номер	X	Y
1	963 972.28	4 450 385.24
2	963 970.31	4 450 384.03
3	963 971.4	4 450 382.17
4	963 973.37	4 450 383.37
5	963 979.52	4 450 368.87
6	963 979.42	4 450 366.73
7	963 961.73	4 450 366.65
8	963 961.65	4 450 368.81
9	963 948.97	4 450 369.74
10	963 948.87	4 450 367.59
11	963 951.18	4 450 367.52
12	963 951.29	4 450 369.68

Перечень координат поворотных точек земельного участка 86-04-0000001-109987-3V2

Номер	X	Y
1	964 009.37	4 450 368.23
2	964 011.7	4 450 368.16
3	964 011.58	4 450 366.01
4	964 009.27	4 450 366.09
5	964 027.53	4 450 379.33
6	964 029.47	4 450 378.31
7	964 027.07	4 450 373.71
8	964 025.18	4 450 374.64

Перечень координат поворотных точек земельного участка 86.04.0000001.109669.3У2

Номер	X	Y	Номер	X	Y
1	965 946.4	4 450 303.21	61	964 028.31	4 450 380.77
2	965 948.86	4 450 302.76	62	964 026.4	4 450 382.11
3	965 948.34	4 450 300.65			
4	965 946.03	4 450 301.11			
5	963 997.52	4 450 322.09			
6	963 999.65	4 450 322.04			
7	963 999.54	4 450 319.88			
8	963 997.38	4 450 319.94			
9	965 127.06	4 450 341.21			
10	965 129.39	4 450 341.16			
11	965 129.27	4 450 339			
12	965 126.96	4 450 339.08			
13	965 037.21	4 450 344.34			
14	965 039.54	4 450 344.28			
15	965 039.42	4 450 342.12			
16	965 037.11	4 450 342.2			
17	964 947.19	4 450 346.62			
18	964 949.52	4 450 346.56			
19	964 949.4	4 450 344.4			
20	964 947.1	4 450 344.47			
21	964 857.3	4 450 348.48			
22	964 859.62	4 450 348.42			
23	964 859.5	4 450 346.26			
24	964 857.2	4 450 346.33			
25	964 767.16	4 450 350.85			
26	964 769.49	4 450 350.79			
27	964 769.37	4 450 348.63			
28	964 767.07	4 450 348.7			
29	964 677.37	4 450 352.62			
30	964 679.71	4 450 352.57			
31	964 679.58	4 450 350.4			
32	964 677.28	4 450 350.48			
33	964 497.36	4 450 356.76			
34	964 499.68	4 450 356.7			
35	964 499.56	4 450 354.54			
36	964 497.26	4 450 354.61			
37	964 407.34	4 450 358.94			
38	964 409.68	4 450 358.87			
39	964 409.56	4 450 356.71			
40	964 407.24	4 450 356.78			
41	964 317.45	4 450 361.09			
42	964 319.77	4 450 361.05			
43	964 319.64	4 450 358.89			
44	964 317.34	4 450 358.97			
45	964 227.44	4 450 362.97			
46	964 229.77	4 450 362.91			
47	964 229.65	4 450 360.76			
48	964 227.34	4 450 360.82			
49	964 137.43	4 450 365.14			
50	964 139.75	4 450 365.07			
51	964 139.63	4 450 362.92			
52	964 137.33	4 450 362.98			
53	964 047.62	4 450 367.22			
54	964 049.95	4 450 367.15			
55	964 049.83	4 450 365			
56	964 047.52	4 450 365.07			
57	964 028.99	4 450 384.18			

Перечень координат поворотных точек земельного участка 86.04.0000001.109668.3У2

Номер	X	Y
1	959 789	4 449 813.1
2	959 790.89	4 449 812.06
3	959 789.83	4 449 810.02
4	959 787.94	4 449 811.04
5	963 864.51	4 450 372.78
6	963 868.83	4 450 372.72
7	963 866.72	4 450 370.56
8	963 864.41	4 450 370.62
9	963 493.43	4 450 382.62
10	963 495.75	4 450 382.56
11	963 495.63	4 450 380.41
12	963 493.34	4 450 380.48
13	963 400.61	4 450 384.56
14	963 402.93	4 450 384.51
15	963 402.81	4 450 382.35
16	963 400.51	4 450 382.42
17	963 307.58	4 450 386.28
18	963 309.9	4 450 386.21
19	963 309.79	4 450 384.05
20	963 307.49	4 450 384.14
21	963 214.77	4 450 388.11
22	963 217.09	4 450 388.05
23	963 216.97	4 450 385.9
24	963 214.67	4 450 385.97
25	964 019.07	4 450 388.71
26	964 022.67	4 450 388.41
27	964 028.99	4 450 384.18
28	964 026.4	4 450 382.11
29	964 021.38	4 450 385.61
30	964 018.73	4 450 385.79
31	963 121.85	4 450 389.73
32	963 124.18	4 450 389.67
33	963 124.06	4 450 387.51
34	963 121.75	4 450 387.58
35	963 993.41	4 450 391.37
36	963 993.27	4 450 388.19
37	963 981.18	4 450 388.39
38	963 979.23	4 450 386.87
39	963 977.43	4 450 388.96
40	963 980.38	4 450 391.21
41	963 029.04	4 450 391.57
42	963 031.35	4 450 391.5
43	963 031.23	4 450 389.35
44	963 028.94	4 450 389.42
45	962 936.23	4 450 393.09
	962 938.55	4 450 393.02
60	960 530.2	4 450 435.57
61	960 444.22	4 450 436.87
62	960 444.3	4 450 434.71
63	960 442	4 450 434.59
64	960 441.9	4 450 438.73
65	960 089.48	4 450 441.65
66	960 091.6	4 450 441.61
67	960 091.6	4 450 438.62
68	960 090.57	4 450 438.64
69	960 088.41	4 450 436.6
70	960 088.43	4 450 440.67
	962 938.43	4 450 390.87
	962 936.13	4 450 390.94
	962 843.3	4 450 395.02
	962 845.63	4 450 394.96
	962 845.51	4 450 392.81
	962 843.21	4 450 392.87
	960 708.99	4 450 433.66
	960 709.06	4 450 431.5
	960 708.76	4 450 431.38
	960 706.67	4 450 433.52

Перечень координат поворотных точек земельного участка № 01-0000001-100007-1/01

Номер	X	Y	Номер	X	Y	Номер	X	Y
1	959 788 36	4 449 846 82	61	963 495 75	4 450 382 56	121	960 057 8	4 450 389 93
2	959 808 14	4 449 821 29	62	963 495 63	4 450 380 41	122	960 045 78	4 450 422 18
3	959 799 53	4 449 802 21	63	963 493 34	4 450 380 48	123	960 089 48	4 450 441 65
4	959 788 08	4 449 808 1	64	963 400 61	4 450 384 56	124	960 091 6	4 450 441 61
5	959 777 37	4 449 813 66	65	963 402 93	4 450 384 51	125	960 098 52	4 450 441 46
6	959 774 36	4 449 817 23	66	963 402 81	4 450 382 35	126	960 098 48	4 450 438 49
7	959 789	4 449 813 1	67	963 400 51	4 450 382 42	127	960 091 6	4 450 438 62
8	959 790 89	4 449 812 06	68	963 307 58	4 450 386 26	128	960 090 57	4 450 438 64
9	959 789 83	4 449 810 02	69	963 308 9	4 450 386 22	129	960 088 41	4 450 438 6
10	959 787 94	4 449 811 04	70	963 308 79	4 450 384 05	130	960 084 82	4 450 433 21
11	963 990 72	4 450 397 94	71	963 307 49	4 450 384 14	131	960 082 77	4 450 436 39
12	964 024 82	4 450 394 74	72	963 214 77	4 450 385 11	132	960 085 43	4 450 440 87
13	964 034 21	4 450 388 36	73	963 217 09	4 450 388 06			
14	964 028 99	4 450 384 18	74	963 216 97	4 450 385 9			
15	964 027 67	4 450 388 41	75	963 214 67	4 450 385 97			
16	964 019 67	4 450 386 71	76	963 121 85	4 450 389 73			
17	964 018 73	4 450 385 79	77	963 124 18	4 450 389 97			
18	964 021 38	4 450 385 81	78	963 124 06	4 450 387 51			
19	964 026 4	4 450 382 11	79	963 121 75	4 450 387 56			
20	963 993 19	4 450 355 49	80	963 028 64	4 450 391 57			
21	963 837 44	4 450 361 11	81	963 031 35	4 450 391 5			
22	963 834 26	4 450 385 06	82	963 031 23	4 450 389 35			
23	963 954 55	4 450 390 41	83	963 028 94	4 450 389 42			
24	963 957 18	4 450 383 19	84	962 936 23	4 450 383 09			
25	963 976 25	4 450 397 8	85	962 938 55	4 450 393 02			
26	963 972 28	4 450 385 24	86	962 938 43	4 450 390 87			
27	963 973 37	4 450 383 37	87	962 936 13	4 450 390 94			
28	963 971 4	4 450 382 17	88	962 843 3	4 450 395 02			
29	963 970 31	4 450 384 03	89	962 845 63	4 450 394 96			
30	963 969 41	4 450 391 37	90	962 845 51	4 450 392 81			
31	963 993 27	4 450 388 19	91	962 843 21	4 450 392 87			
32	963 981 18	4 450 388 39	92	960 637 72	4 450 452 84			
33	963 979 23	4 450 386 87	93	960 750 74	4 450 451 46			
34	963 977 43	4 450 388 96	94	960 771 22	4 450 423 86			
35	963 960 36	4 450 391 21	95	960 756 98	4 450 424 11			
36	963 979 52	4 450 368 87	96	960 756 98	4 450 416 31			
37	963 981 85	4 450 368 81	97	960 698 27	4 450 417 13			
38	963 981 73	4 450 366 65	98	960 708 99	4 450 433 66			
39	963 979 42	4 450 366 73	99	960 709 06	4 450 431 5			
40	963 966 2	4 450 371 27	100	960 706 78	4 450 431 38			
41	963 982 49	4 450 371 16	101	960 706 67	4 450 433 52			
42	963 962 4	4 450 366 99	102	960 419 62	4 450 455 49			
43	963 956 22	4 450 367 17	103	960 529 18	4 450 454 16			
44	963 948 97	4 450 369 74	104	960 548 99	4 450 418 26			
45	963 951 29	4 450 369 68	105	960 440 78	4 450 419 29			
46	963 951 18	4 450 367 52	106	960 532 52	4 450 435 72			
47	963 948 87	4 450 367 59	107	960 532 59	4 450 433 56			
48	963 864 51	4 450 372 78	108	960 530 3	4 450 433 43			
49	963 886 83	4 450 372 72	109	960 530 2	4 450 435 57			
50	963 886 72	4 450 370 56	110	960 444 22	4 450 436 87			
51	963 864 41	4 450 370 62	111	960 444 3	4 450 434 71			
52	962 854 83	4 450 405 85	112	960 442	4 450 434 69			
53	963 640 07	4 450 390 9	113	960 441 9	4 450 436 73			
54	963 489 61	4 450 373 56	114	960 083 35	4 450 457 21			
55	963 283 52	4 450 377 56	115	960 134 41	4 450 456 71			
56	963 283 46	4 450 373 93	116	960 150 48	4 450 432 29			
57	962 942 32	4 450 379 92	117	960 155 31	4 450 424 97			

Перечень координат поворотных точек земельного участка № 01-0000001-36247-3/07

Номер	X	Y
1	954 389 33	4 430 020 22
2	954 388 63	4 430 017 3
3	954 391 37	4 430 016 65
4	954 392 45	4 430 014 09
5	954 395 34	4 430 014 68
6	954 393 96	4 430 019 08
7	957 318 71	4 412 614 44
8	957 318 31	4 412 612 27
9	957 320 56	4 412 611 86
10	957 320 97	4 412 614 02

Перечень координат поворотных точек земельного участка № 01-0000001-37150-3/07

Номер	X	Y
1	964 072 8	4 443 242 44
2	964 075 12	4 443 242 35
3	964 074 87	4 443 241 02
4	964 072 61	4 443 241 45
5	963 711 38	4 443 380 78
6	963 716 49	4 443 379 56
7	963 715 95	4 443 377 3
8	963 710 82	4 443 378 45
9	963 521 81	4 443 416 88
10	963 523 52	4 443 416 44
11	963 521 79	4 443 416 5
12	964 496 03	4 443 478 77
13	964 497 87	4 443 477 56
14	964 496 58	4 443 475 66
15	964 494 75	4 443 476 91
16	962 269 13	4 443 709 37
17	962 272 93	4 443 708 35
18	962 272 2	4 443 705 44
19	962 268 28	4 443 706 45
20	961 709 44	4 443 639 28
21	961 740 47	4 443 631 81
22	961 740 47	4 443 631 81
23	961 709 44	4 443 639 28
24	964 672 3	4 444 000 25
25	964 675 09	4 444 000 12
26	964 674 14	4 443 998 89
27	964 672 26	4 444 000 2

Перечень координат поворотных точек земельного участка №6:04:0000001:109982:3У1

Лист 64 из 134

Номер	X	Y	Номер	X	Y	Номер	X	Y
1	965 954.31	4 450 307.8	61	964 949.52	4 450 346.56	121	964 049.83	4 450 365
2	965 964.23	4 450 305.61	62	964 949.4	4 450 344.4	122	964 047.52	4 450 365.07
3	965 963.05	4 450 298.91	63	964 947.1	4 450 344.47	123	964 009.37	4 450 368.23
4	965 957.87	4 450 299.59	64	964 857.3	4 450 348.48	124	964 011.7	4 450 368.16
5	965 957.56	4 450 300.27	65	964 859.62	4 450 348.42	125	964 011.58	4 450 366.01
6	965 958.94	4 450 301.43	66	964 859.5	4 450 348.26	126	964 009.27	4 450 368.09
7	965 954.26	4 450 307.02	67	964 857.2	4 450 346.33			
8	965 932.78	4 450 311.39	68	964 767.16	4 450 350.85			
9	965 947.37	4 450 308.71	69	964 769.49	4 450 350.79			
10	965 946.39	4 450 303.21	70	964 769.37	4 450 348.63			
11	965 946.03	4 450 301.11	71	964 767.07	4 450 348.7			
12	965 945.65	4 450 298.9	72	964 677.37	4 450 352.62			
13	965 947.82	4 450 298.48	73	964 679.71	4 450 352.57			
14	965 948.35	4 450 300.65	74	964 679.58	4 450 350.4			
15	965 948.86	4 450 302.76	75	964 677.28	4 450 350.48			
16	965 949.01	4 450 303.37	76	964 034.21	4 450 388.35			
17	965 954.06	4 450 294.13	77	964 040.35	4 450 384.18			
18	965 961.96	4 450 293.02	78	964 040.62	4 450 379.94			
19	965 959.62	4 450 281.4	79	964 040.7	4 450 378.06			
20	965 958.43	4 450 273.89	80	964 090.2	4 450 376.93			
21	965 944.64	4 450 279.28	81	964 137.79	4 450 375.84			
22	965 945.93	4 450 286.1	82	964 548.3	4 450 366.49			
23	965 942.99	4 450 286.65	83	964 537.69	4 450 342.8			
24	965 941.81	4 450 280.38	84	964 033.34	4 450 354.44			
25	965 931.24	4 450 284.52	85	964 029.39	4 450 354.53			
26	965 888.7	4 450 304.72	86	964 027.81	4 450 351.49			
27	965 888.75	4 450 304.95	87	964 005.62	4 450 352.12			
28	965 925.65	4 450 297.75	88	964 007.2	4 450 355.25			
29	965 926.02	4 450 299.32	89	964 002.65	4 450 355.15			
30	965 930.49	4 450 298.94	90	963 993.19	4 450 355.49			
31	963 992.69	4 450 326.46	91	964 026.4	4 450 382.11			
32	964 014.38	4 450 325.74	92	964 028.31	4 450 380.77			
33	964 009.99	4 450 317.53	93	964 027.53	4 450 379.33			
34	964 001.82	4 450 318.94	94	964 025.18	4 450 374.64			
35	964 001.72	4 450 318.98	95	964 027.07	4 450 373.71			
36	964 001.59	4 450 323.76	96	964 029.47	4 450 378.31			
37	963 997.63	4 450 323.74	97	964 031.82	4 450 382.3			
38	963 997.65	4 450 323.99	98	964 028.99	4 450 384.18			
39	963 991.64	4 450 324.38	99	964 497.36	4 450 356.76			
40	964 002.82	4 450 346.16	100	964 499.68	4 450 356.7			
41	964 024.71	4 450 345.54	101	964 499.58	4 450 354.54			
42	964 017.47	4 450 331.66	102	964 497.26	4 450 354.61			
43	963 995.67	4 450 332.38	103	964 407.34	4 450 358.94			
44	964 688.81	4 450 363.29	104	964 409.68	4 450 358.87			
45	965 127.53	4 450 353.29	105	964 409.56	4 450 356.71			
46	965 135.02	4 450 352.89	106	964 407.24	4 450 356.78			
47	965 206.26	4 450 335.25	107	964 317.45	4 450 361.09			
48	965 189.97	4 450 325.81	108	964 319.77	4 450 361.05			
49	965 126.66	4 450 329.21	109	964 319.64	4 450 358.89			
50	964 628.31	4 450 340.71	110	964 317.33	4 450 358.97			
51	964 685.12	4 450 362.45	111	964 227.44	4 450 362.97			
52	965 127.06	4 450 341.21	112	964 229.77	4 450 362.91			
53	965 129.39	4 450 341.16	113	964 229.65	4 450 360.76			
54	965 129.27	4 450 339	114	964 227.34	4 450 360.82			
55	965 126.96	4 450 339.08	115	964 137.43	4 450 365.14			
56	965 037.21	4 450 344.34	116	964 139.75	4 450 365.07			
57	965 039.54	4 450 344.28	117	964 139.83	4 450 362.92			

Перечень координат поворотных точек земельного участка №6:04:0000001:109981:3У1

Номер	X	Y
1	964 090.2	4 450 376.93
2	964 137.79	4 450 375.84
3	964 137.18	4 450 376.13
4	964 129.26	4 450 381.97
5	964 127.95	4 450 390.21
6	964 100.36	4 450 389.51
7	964 097.14	4 450 380.63

Перечень координат поворотных точек земельного участка №6:04:0000001:109968:3У1

Номер	X	Y
1	960 091.6	4 450 438.62
2	960 098.47	4 450 438.49
3	960 098.52	4 450 441.48
4	960 091.6	4 450 441.61
5	963 956.2	4 450 371.27
6	963 956.22	4 450 367.17
7	963 962.4	4 450 366.99
8	963 962.49	4 450 371.18
9	960 084.82	4 450 433.21
10	960 088.41	4 450 436.6
11	960 088.43	4 450 440.67
12	960 082.77	4 450 435.39

Перечень координат поворотных точек земельного участка №6:04:0000001:109969:3У1

Номер	X	Y
1	965 948.86	4 450 302.76
2	965 949.01	4 450 303.37
3	965 947.88	4 450 305.45
4	965 948.13	4 450 306.95
5	965 947.42	4 450 307.08
6	965 947.71	4 450 308.65
7	965 947.37	4 450 308.71
8	965 946.4	4 450 303.21
9	965 941.81	4 450 280.38
10	965 944.64	4 450 279.28
11	965 945.93	4 450 286.1
12	965 942.99	4 450 286.65
13	965 947.81	4 450 298.48
14	965 948.34	4 450 300.65
15	965 946.03	4 450 301.11
16	965 945.65	4 450 298.9

Перечень координат поворотных точек земельного участка №6:04:000001:36737:3V6

Номер	X	Y	Номер	X	Y
1	959 808.14	4 449 821.29	61	964 048.1	4 450 381.69
2	959 810.34	4 449 818.46	62	964 086.42	4 450 380.18
3	959 802.04	4 449 800.9	63	964 092.76	4 450 382.95
4	959 789.53	4 449 802.2	64	964 094.87	4 450 389.93
5	959 799.53	4 449 802.21	65	964 097.75	4 450 382.48
6	965 961.96	4 450 283.02	66	962 858.23	4 450 408.4
7	965 976.35	4 450 291.02	67	963 661.09	4 450 393.32
8	965 975.2	4 450 280.59	68	963 640.08	4 450 390.9
9	965 973.27	4 450 282.96	69	963 640.07	4 450 390.9
10	965 970.91	4 450 281.1	70	963 640.07	4 450 390.9
11	965 959.82	4 450 281.4	71	962 854.83	4 450 405.85
12	964 001.59	4 450 323.76	72	960 689.27	4 450 417.13
13	964 001.72	4 450 318.86	73	960 756.96	4 450 418.31
14	963 999.54	4 450 318.88	74	960 756.96	4 450 413.22
15	963 999.65	4 450 322.84	75	960 671.83	4 450 414.25
16	963 997.52	4 450 322.09	76	960 440.76	4 450 419.29
17	963 997.83	4 450 323.74	77	960 548.98	4 450 418.25
18	964 029.39	4 450 354.53	78	960 550.4	4 450 415.7
19	964 033.34	4 450 354.44	79	960 442.11	4 450 416.98
20	964 022.73	4 450 334.06			
21	964 025.76	4 450 328.89			
22	964 018.82	4 450 313.59			
23	964 014.78	4 450 312.32			
24	964 001.82	4 450 318.84			
25	964 009.99	4 450 317.53			
26	964 014.36	4 450 325.74			
27	963 992.89	4 450 326.46			
28	963 995.87	4 450 332.38			
29	964 017.47	4 450 331.86			
30	964 024.71	4 450 345.54			
31	964 002.82	4 450 346.16			
32	964 005.82	4 450 352.12			
33	964 027.81	4 450 351.49			
34	964 701.97	4 450 366.18			
35	965 089.98	4 450 357.35			
36	965 090.05	4 450 357.34			
37	965 124.18	4 450 355.58			
38	965 135.02	4 450 352.89			
39	965 127.53	4 450 353.29			
40	964 688.81	4 450 363.29			
41	963 833.89	4 450 387.89			
42	963 957.16	4 450 383.19			
43	963 984.55	4 450 380.41			
44	963 834.26	4 450 385.06			
45	964 125.43	4 450 383.23			
46	964 128.43	4 450 390.48			
47	964 129.96	4 450 382.51			
48	964 135.86	4 450 379.05			
49	964 476.78	4 450 371.3			
50	964 549.72	4 450 369.64			
51	964 548.3	4 450 366.49			
52	964 137.79	4 450 375.84			
53	964 137.18	4 450 376.13			
54	964 129.26	4 450 381.97			
55	964 127.95	4 450 390.21			
56	964 100.36	4 450 389.51			
57	964 097.14	4 450 390.83			
58	964 090.2	4 450 376.93			
59	964 040.7	4 450 378.06			
60	964 040.62	4 450 379.94			

Перечень координат поворотных точек
земельного участка
№6:04:000001:1096675:3V2

Номер	X	Y
1	957 333.43	4 412 761
2	957 333.32	4 412 758.8
3	957 335.82	4 412 758.88
4	957 335.73	4 412 760.89
5	957 337.54	4 412 844.2
6	957 337.43	4 412 842.01
7	957 339.72	4 412 841.89
8	957 339.84	4 412 844.09
9	957 341.21	4 412 825.67
10	957 344.23	4 412 825.81
11	957 344.28	4 412 826.91
12	957 343.97	4 412 828.42
13	957 340.95	4 412 828.17
14	957 341.26	4 412 826.66
15	957 329.13	4 412 998.33
16	957 326.88	4 412 997.87
17	957 327.34	4 412 995.7
18	957 326.98	4 412 996.18
19	957 315.05	4 413 068.19
20	957 313.94	4 413 068.86
21	957 311.34	4 413 066.94
22	957 312.37	4 413 086.32
23	957 312.7	4 413 084.72
24	957 315.39	4 413 086.51
25	957 308.84	4 412 547.25
26	957 310.18	4 412 547.6
27	957 310.4	4 412 549.02
28	957 307.78	4 412 551.49
29	957 307.53	4 412 550.03
30	957 308.21	4 412 549.68
31	957 328.47	4 412 679.8
32	957 329.32	4 412 676.77
33	957 328.81	4 412 673.77
34	957 330.96	4 412 673.41
35	957 331.52	4 412 675.56
36	957 331.67	4 412 679.68

Перечень координат поворотных точек земельного участка
№6:04:000001:109985:3V2

Номер	X	Y
1	983 679.01	4 443 388.46
2	983 682.53	4 443 387.81
3	983 682.78	4 443 384.83
4	983 678.47	4 443 385.54
5	981 774.79	4 443 823.57
6	981 794.46	4 443 816.84
7	981 796.84	4 443 818.24
8	981 796.37	4 443 816.69
9	981 774.17	4 443 821.86
10	981 709.44	4 443 839.28
11	981 734.96	4 443 833.14
12	981 734.23	4 443 831.2
13	981 769.88	4 443 837.18
14	980 764.14	4 444 595.32
15	980 764.84	4 444 593.18
16	980 763.96	4 444 593.05
17	980 763.55	4 444 595.2

Перечень координат поворотных точек
земельного участка 86:04:0080001:109999:3У2

Номер	X	Y
1	956 211.92	4 415 473.24
2	956 209.73	4 415 472.57
3	956 210.38	4 415 470.46
4	956 212.58	4 415 471.13
5	956 184.47	4 416 736.68
6	956 183.36	4 416 734.86
7	956 165.3	4 415 733.62
8	956 166.41	4 415 735.63
9	955 603.25	4 416 505.75
10	955 601.05	4 416 505.08
11	955 601.71	4 416 502.97
12	955 603.91	4 416 503.65
13	955 578.94	4 416 582.51
14	955 576.74	4 416 581.83
15	955 577.4	4 416 579.73
16	955 579.6	4 416 580.4
17	955 566.2	4 416 658.28
18	955 553.28	4 416 657.6
19	955 554.11	4 416 654.05
20	955 555.18	4 416 650.76
21	955 558.04	4 416 651.68
22	955 566.99	4 416 654.92
23	955 533.38	4 416 742.75
24	955 531.15	4 416 742.2
25	955 531.66	4 416 740.08
26	955 533.91	4 416 740.62
27	955 510.28	4 416 829.89
28	955 508.05	4 416 829.34
29	955 508.58	4 416 827.21
30	955 510.81	4 416 827.76
31	955 485.97	4 416 923.48
32	955 483.07	4 416 922.71
33	955 484.88	4 416 915.92
34	955 487.78	4 416 916.69
35	955 433.39	4 417 125.52
36	955 430.48	4 417 124.76
37	955 470.58	4 416 972.34
38	955 472.82	4 416 972.93
39	955 074.01	4 418 692.24
40	955 081.69	4 418 746.46
41	955 078.72	4 418 746.87
42	955 072.59	4 418 704.02
43	954 551.69	4 423 165.17
44	954 549.2	4 423 163.5
45	954 553.43	4 423 167.85
46	954 555.95	4 423 159.28
47	954 265.81	4 430 530.31
48	954 268.79	4 430 530.54
49	954 263.55	4 430 582.85
50	954 260.55	4 430 582.75

Перечень координат поворотных точек земельного участка 86:04:0901001:32261:3У2

Номер	X	Y	Номер	X	Y
1	984 119.75	4 443 231.34	61	983 517.21	4 443 417.96
2	984 122	4 443 230.94	62	983 521.81	4 443 416.88
3	984 121.59	4 443 228.75	63	983 521.79	4 443 416.5
4	984 119.33	4 443 228.16	64	983 523.52	4 443 416.44
5	984 073.03	4 443 243.61	65	983 522.85	4 443 413.77
6	984 075.28	4 443 243.21	66	983 516.53	4 443 415.21
7	984 075.12	4 443 242.35	67	983 456.51	4 443 431
8	984 072.8	4 443 242.44	68	983 456.76	4 443 430.6
9	984 203.81	4 443 246.61	69	983 458.35	4 443 428.41
10	984 204.16	4 443 244.4	70	983 456.89	4 443 428.84
11	984 201.87	4 443 244.05	71	983 394.04	4 443 444.67
12	984 201.55	4 443 246.23	72	983 396.29	4 443 444.28
13	984 081.47	4 443 249.57	73	983 395.88	4 443 442.08
14	984 085.02	4 443 248.94	74	983 393.62	4 443 442.51
15	984 084.85	4 443 246.28	75	983 328.46	4 443 459.15
16	984 081.27	4 443 246.19	76	983 335.78	4 443 457.68
17	984 285.41	4 443 261.61	77	983 335.1	4 443 454.97
18	984 285.76	4 443 259.4	78	983 328.78	4 443 456.41
19	984 283.48	4 443 259.05	79	983 257.64	4 443 474.41
20	984 283.16	4 443 261.23	80	983 259.89	4 443 474.01
21	984 365.64	4 443 277.31	81	983 259.48	4 443 471.81
22	984 366.81	4 443 275.36	82	983 257.22	4 443 472.24
23	984 364.86	4 443 274.24	83	983 183.8	4 443 490.55
24	984 363.73	4 443 276.23	84	983 186.05	4 443 490.15
25	984 068.67	4 443 292.35	85	983 185.64	4 443 487.96
26	984 070.92	4 443 291.96	86	983 183.38	4 443 488.39
27	984 070.61	4 443 289.76	87	983 110.94	4 443 506.6
28	984 068.25	4 443 290.19	88	983 112.29	4 443 506.21
29	983 993.67	4 443 311.05	89	983 111.88	4 443 504.01
30	983 995.92	4 443 310.66	90	983 109.62	4 443 504.44
31	983 995.51	4 443 308.46	91	983 036.26	4 443 522.57
32	983 993.25	4 443 308.89	92	983 036.53	4 443 522.18
33	983 917.88	4 443 329.84	93	983 038.12	4 443 519.88
34	983 920.13	4 443 329.45	94	983 035.86	4 443 520.41
35	983 919.72	4 443 327.25	95	982 962.43	4 443 538.54
36	983 917.46	4 443 327.68	96	982 964.68	4 443 538.15
37	984 406.62	4 443 344.12	97	982 964.27	4 443 535.95
38	984 410.63	4 443 343.03	98	982 962.01	4 443 536.38
39	984 409.54	4 443 341.07	99	984 539.21	4 443 546.13
40	984 407.53	4 443 342.2	100	984 541.24	4 443 545.1
41	983 842.19	4 443 348.55	101	984 540.14	4 443 543.25
42	983 844.44	4 443 348.16	102	984 538.11	4 443 544.32
43	983 844.03	4 443 345.96	103	982 888.75	4 443 554.69
44	983 841.77	4 443 346.39	104	982 891	4 443 554.29
45	983 776.74	4 443 365.05	105	982 890.59	4 443 552.1
46	983 778.96	4 443 364.52	106	982 888.33	4 443 552.53
47	983 778.56	4 443 362.37	107	982 815.06	4 443 570.75
48	983 776.3	4 443 362.8	108	982 817.33	4 443 570.35
49	983 710.19	4 443 381.06	109	982 816.82	4 443 568.16
50	983 711.39	4 443 380.78	110	982 814.66	4 443 568.59
51	983 710.82	4 443 378.45	111	982 739.23	4 443 587.52
52	983 709.62	4 443 378.72	112	982 745.55	4 443 586.05
53	983 581.7	4 443 405.77	113	982 744.87	4 443 583.34
54	983 583.95	4 443 405.38	114	982 738.55	4 443 584.77
55	983 583.54	4 443 403.18	115	984 582.79	4 443 613.55
56	983 581.28	4 443 403.61	116	984 584.82	4 443 612.51
57	984 452.3	4 443 411.7	117	984 583.72	4 443 610.66

Номер	X	Y	Номер	X	Y	Номер	X	Y
121	982 703.54	4 443 592.86	181	981 627.22	4 443 858.35	241	980 868.59	4 444 134.97
122	982 613.73	4 443 612.4	182	981 626.74	4 443 856.17	242	980 866.34	4 444 134.55
123	982 597.26	4 443 618.17	183	981 624.5	4 443 856.87	243	980 865.93	4 444 136.7
124	982 599.5	4 443 617.7	184	981 551.5	4 443 875.93	244	984 905.09	4 444 149.49
125	982 599.02	4 443 615.53	185	981 553.74	4 443 875.47	245	984 907.84	4 444 148.96
126	982 596.78	4 443 616.02	186	981 553.26	4 443 873.29	246	984 906.66	4 444 142.56
127	982 531.57	4 443 635.81	187	981 551.02	4 443 873.79	247	984 903.89	4 444 143.13
128	982 533.79	4 443 635.26	188	981 478.18	4 443 892.87	248	980 850.94	4 444 213.52
129	982 533.47	4 443 633.79	189	981 480.42	4 443 892.41	249	980 851.39	4 444 211.38
130	982 531.23	4 443 634.28	190	981 479.94	4 443 890.23	250	980 848.14	4 444 210.95
131	984 626.2	4 443 680.86	191	981 477.7	4 443 890.73	251	980 848.73	4 444 213.1
132	984 628.23	4 443 679.83	192	984 790.81	4 443 894.59	252	984 925.48	4 444 221.85
133	984 627.29	4 443 678.24	193	984 792.7	4 443 893.32	253	984 927.7	4 444 221.57
134	984 626.6	4 443 678.25	194	984 791.38	4 443 891.61	254	984 927.37	4 444 219.44
135	984 625.1	4 443 679.04	195	984 789.5	4 443 892.92	255	984 925.09	4 444 219.69
136	982 335.14	4 443 690.77	196	981 404.87	4 443 910.17	256	984 953.85	4 444 287.4
137	982 337.38	4 443 690.31	197	981 407.11	4 443 909.7	257	984 956	4 444 286.69
138	982 336.96	4 443 688.41	198	981 406.63	4 443 907.53	258	984 955.26	4 444 284.65
139	982 334.74	4 443 688.96	199	981 404.39	4 443 908.02	259	984 953.07	4 444 285.34
140	982 266.49	4 443 709.89	200	981 330.93	4 443 927.02	260	980 834	4 444 289.92
141	982 269.13	4 443 709.37	201	981 333.17	4 443 926.56	261	980 834.45	4 444 287.78
142	982 268.28	4 443 706.46	202	981 332.69	4 443 924.38	262	980 832.19	4 444 287.36
143	982 265.81	4 443 707.14	203	981 330.45	4 443 924.67	263	980 831.78	4 444 289.51
144	982 193.19	4 443 726.67	204	981 257.35	4 443 944.49	264	984 982.47	4 444 354.14
145	982 195.43	4 443 726.21	205	981 259.59	4 443 944.03	265	984 984.62	4 444 353.43
146	982 194.95	4 443 724.03	206	981 258.11	4 443 941.85	266	984 983.88	4 444 351.39
147	982 192.71	4 443 724.52	207	981 256.87	4 443 942.35	267	984 981.69	4 444 352.09
148	984 667.3	4 443 734.19	208	984 832.1	4 443 948.23	268	980 817.05	4 444 366.33
149	984 669.19	4 443 732.92	209	984 833.99	4 443 946.96	269	980 817.5	4 444 364.19
150	984 667.87	4 443 731.21	210	984 832.67	4 443 945.25	270	980 815.25	4 444 363.76
151	984 665.99	4 443 732.53	211	984 830.79	4 443 946.56	271	980 814.84	4 444 365.91
152	982 117.75	4 443 744.22	212	981 183.68	4 443 961.53	272	985 010.87	4 444 403.81
153	982 119.99	4 443 743.76	213	981 185.92	4 443 961.06	273	985 012.88	4 444 402.77
154	982 119.73	4 443 742.59	214	981 185.44	4 443 968.89	274	985 011.82	4 444 400.87
155	982 117.51	4 443 743.14	215	981 183.2	4 443 959.38	275	985 009.76	4 444 401.9
156	984 708.67	4 443 787.57	216	981 110.36	4 443 978.45	276	980 798.76	4 444 442.64
157	984 710.56	4 443 786.3	217	981 112.6	4 443 977.99	277	980 800.21	4 444 440.5
158	984 709.24	4 443 784.59	218	981 112.12	4 443 975.81	278	980 797.96	4 444 440.07
159	984 707.36	4 443 785.91	219	981 109.88	4 443 976.31	279	980 797.55	4 444 442.23
160	981 890.78	4 443 795.64	220	981 036.96	4 443 995.66	280	985 037.6	4 444 450.88
161	981 893.01	4 443 795.1	221	981 039.2	4 443 995.2	281	985 039.61	4 444 449.84
162	981 892.64	4 443 794.33	222	981 038.72	4 443 993.02	282	985 038.55	4 444 447.94
163	981 890.6	4 443 794.82	223	981 036.48	4 443 993.52	283	985 036.58	4 444 448.93
164	981 796.94	4 443 818.24	224	984 873.57	4 444 001.86	284	985 036.6	4 444 449.16
165	981 829.09	4 443 810.5	225	984 875.46	4 444 000.59	285	985 068.16	4 444 504.48
166	981 828.79	4 443 809.15	226	984 875.09	4 444 000.12	286	985 070.11	4 444 503.47
167	981 796.37	4 443 816.69	227	984 872.3	4 444 000.25	287	985 069.57	4 444 502.48
168	981 734.96	4 443 833.14	228	980 963.32	4 444 012.94	288	985 067.44	4 444 503.16
169	981 774.79	4 443 823.57	229	980 965.38	4 444 012.23	289	980 782.15	4 444 519.18
170	981 774.17	4 443 821.88	230	980 964.58	4 444 010.88	290	980 782.69	4 444 517.06
171	981 734.23	4 443 831.2	231	980 962.53	4 444 010.84	291	980 781.01	4 444 516.74
172	984 749.7	4 443 841.21	232	980 890.03	4 444 067.31	292	980 780.6	4 444 518.9
173	984 751.59	4 443 839.94	233	980 891.37	4 444 065.57	293	985 092.93	4 444 547.11
174	984 750.27	4 443 838.23	234	980 890.43	4 444 065.02	294	985 094.37	4 444 546.36
175	984 748.39	4 443 839.54	235	980 889.5	4 444 067	295	985 093.31	4 444 544.46
176	981 685.66	4 443 845.05	236	984 888.91	4 444 074.31	296	985 091.24	4 444 545.49
177	981 709.44	4 443 839.28	237	984 891.15	4 444 074.03	297	985 091.56	4 444 546.04

Перечень координат поворотных точек земельного участка 86-04-000001-32261-3V2

Номер	X	Y	Номер	X	Y
301	985 117.62	4 444 617.3	360	985 418.76	4 445 707.78
302	985 115.41	4 444 617.96	361	985 416.82	4 445 706.79
303	985 139.96	4 444 692.65	362	985 415.67	4 445 708.76
304	985 142.34	4 444 691.92	363	985 380.89	4 445 781.98
305	985 141.62	4 444 689.87	364	985 382.07	4 445 779.95
306	985 139.41	4 444 690.53	365	985 360.13	4 445 778.96
307	985 164.31	4 444 765.3	366	985 378.98	4 445 780.93
308	985 166.8	4 444 764.56	367	985 343.7	4 445 856.3
309	985 165.88	4 444 762.52	368	985 346.91	4 445 850.64
310	985 163.67	4 444 763.18	369	985 344.43	4 445 849.31
311	985 188.21	4 444 838.18	370	985 344.26	4 445 849.6
312	985 190.47	4 444 837.46	371	985 344.29	4 445 850.27
313	985 189.75	4 444 835.4	372	985 343.87	4 445 850.29
314	985 187.54	4 444 836.06	373	985 341.25	4 445 854.95
315	985 212.38	4 444 910.79	374	985 302.69	4 445 907.48
316	985 214.64	4 444 910.07	375	985 304.21	4 445 905.69
317	985 213.92	4 444 908.01	376	985 302.48	4 445 904.38
318	985 211.71	4 444 908.67	377	985 301	4 445 906.11
319	985 236.41	4 444 983.59	378	985 260.57	4 445 961.96
320	985 238.67	4 444 982.86	379	985 265.13	4 445 957.32
321	985 237.95	4 444 980.81	380	985 263.07	4 445 955.39
322	985 235.74	4 444 981.47	381	985 258.55	4 445 960.02
323	985 260.5	4 445 056.37	382	985 201.06	4 446 011.66
324	985 262.76	4 445 055.64	383	985 202.93	4 446 010.24
325	985 262.04	4 445 053.59	384	985 201.52	4 446 008.59
326	985 259.83	4 445 054.25	385	985 199.71	4 446 009.97
327	985 284.41	4 445 129.98			
328	985 286.67	4 445 128.35			
329	985 285.95	4 445 126.3			
330	985 283.74	4 445 126.96			
331	985 308.45	4 445 201.61			
332	985 310.72	4 445 201.02			
333	985 310.08	4 445 198.94			
334	985 307.85	4 445 199.51			
335	985 332.72	4 445 274.4			
336	985 334.99	4 445 273.6			
337	985 334.35	4 445 271.73			
338	985 332.12	4 445 272.29			
339	985 358.11	4 445 346.78			
340	985 359.04	4 445 346.48			
341	985 358.23	4 445 344.46			
342	985 358.06	4 445 344.52			
343	985 380.68	4 445 419.78			
344	985 382.95	4 445 419.16			
345	985 382.26	4 445 417.99			
346	985 380.05	4 445 417.7			
347	985 404.71	4 445 492.62			
348	985 406.98	4 445 491.99			
349	985 406.29	4 445 489.93			
350	985 404.08	4 445 490.53			
351	985 428.87	4 445 565.41			
352	985 431.14	4 445 564.78			
353	985 430.45	4 445 562.72			
354	985 428.24	4 445 563.32			
355	985 454.58	4 445 637.67			
356	985 454.52	4 445 635.49			
357	985 452.23	4 445 635.45			

Перечень координат поворотных точек земельного участка 86-04-000001-110005-3V2

Номер	X	Y
1	956 603.71	4 414 021.81
2	956 601.82	4 414 020.83
3	956 602.56	4 414 018.84
4	956 604.63	4 414 019.8
5	956 566.34	4 414 102.25
6	956 564.26	4 414 101.29
7	956 565.19	4 414 099.28
8	956 567.28	4 414 100.26
9	956 528.97	4 414 182.7
10	956 526.89	4 414 181.73
11	956 527.82	4 414 179.74
12	956 529.9	4 414 180.66
13	956 492.09	4 414 262.97
14	956 492.12	4 414 264.18
15	956 489.11	4 414 263.72
16	956 489.07	4 414 262.35
17	956 489.55	4 414 281.32
18	956 492.61	4 414 261.85
19	956 491.54	4 414 337.06
20	956 491.48	4 414 334.86
21	956 493.78	4 414 334.8
22	956 493.94	4 414 336.99
23	956 493.82	4 414 410.32
24	956 493.56	4 414 408.13
25	956 495.85	4 414 408.07
26	956 495.91	4 414 410.27
27	956 495.7	4 414 483.6
28	956 495.84	4 414 481.4
29	956 497.94	4 414 481.34
30	956 497.99	4 414 483.54
31	956 500.39	4 414 555.48
32	956 500.08	4 414 556.64
33	956 497.06	4 414 556.62
34	956 497.38	4 414 555.21
35	956 497.34	4 414 553.6
36	956 500.34	4 414 553.76
37	956 486.39	4 414 616.09
38	956 484.15	4 414 615.59
39	956 484.83	4 414 613.44
40	956 486.87	4 414 613.94
41	956 466.93	4 414 702.62
42	956 464.68	4 414 702.12
43	956 465.17	4 414 689.96
44	956 467.42	4 414 700.46
45	956 447.46	4 414 789.17
46	956 445.22	4 414 788.66
47	956 445.7	4 414 786.51
48	956 447.94	4 414 787.02
49	956 427.99	4 414 875.71
50	956 425.75	4 414 875.2
51	956 426.23	4 414 873.05
52	956 428.47	4 414 873.56
53	956 408.52	4 414 962.23
54	956 406.26	4 414 961.75
55	956 406.74	4 414 959.59
56	956 409	4 414 960.1

Номер	X	Y	Номер	X	Y	Номер	X	Y
59	956 387.28	4 415 046.13	119	955 383.35	4 417 303.41	179	954 836.13	4 420 682.97
60	956 389.53	4 415 046.62	120	955 385.56	4 417 304	180	954 838.34	4 420 683.6
61	956 369.57	4 415 135.32	121	955 382.78	4 417 390.99	181	954 813.35	4 420 771.01
62	956 367.33	4 415 134.82	122	955 382.22	4 417 392.21	182	954 811.14	4 420 770.39
63	956 367.81	4 415 132.67	123	955 359.36	4 417 391.24	183	954 811.75	4 420 768.28
64	956 370.05	4 415 133.17	124	955 359.95	4 417 389.95	184	954 813.96	4 420 768.9
65	956 350.08	4 415 221.86	125	955 360.24	4 417 388.87	185	954 788.99	4 420 856.32
66	956 347.85	4 415 221.35	126	955 363.12	4 417 389.7	186	954 786.78	4 420 855.69
67	956 348.34	4 415 219.21	127	955 324.79	4 417 472.17	187	954 787.39	4 420 853.57
68	956 350.57	4 415 219.72	128	955 322.7	4 417 471.21	188	954 789.6	4 420 854.2
69	956 330.64	4 415 308.36	129	955 323.64	4 417 469.22	189	954 764.61	4 420 941.8
70	956 328.39	4 415 307.85	130	955 325.72	4 417 470.19	190	954 762.4	4 420 940.97
71	956 328.88	4 415 305.7	131	955 287.51	4 417 552.65	191	954 763.01	4 420 938.85
72	956 331.12	4 415 306.21	132	955 285.43	4 417 551.68	192	954 765.21	4 420 939.47
73	956 310.54	4 415 396.88	133	955 286.36	4 417 549.69	193	954 740.95	4 421 025.63
74	956 306.41	4 415 396.31	134	955 288.45	4 417 550.66	194	954 741.1	4 421 026.79
75	956 309.21	4 415 393.33	135	955 248.65	4 417 630.27	195	954 738.1	4 421 026.79
76	956 309.88	4 415 390.34	136	955 251.52	4 417 631.2	196	954 737.93	4 421 025.42
77	956 312.03	4 415 390.82	137	955 251.07	4 417 632.16	197	954 738.27	4 421 024.22
78	956 311.34	4 415 393.88	138	955 250.73	4 417 633.45	198	954 741.35	4 421 024.22
79	956 287.37	4 415 482.5	139	955 247.86	4 417 632.57	199	954 747.95	4 421 102.11
80	956 283.16	4 415 481.19	140	955 248.23	4 417 631.19	200	954 747.67	4 421 099.93
81	956 284.86	4 415 475.35	141	955 227.9	4 417 718.23	201	954 749.96	4 421 099.64
82	956 289.1	4 415 476.49	142	955 225.68	4 417 717.63	202	954 750.23	4 421 101.83
83	956 243.27	4 415 479.06	143	955 228.24	4 417 715.5	203	954 759.05	4 421 190.11
84	956 244.55	4 415 479.57	144	955 228.46	4 417 716.1	204	954 758.78	4 421 187.92
85	956 245.69	4 415 479.52	145	955 205.17	4 417 804	205	954 761.05	4 421 187.63
86	956 245.25	4 415 482.51	146	955 202.95	4 417 803.41	206	954 761.33	4 421 189.83
87	956 244.1	4 415 482.56	147	955 203.51	4 417 801.28	207	954 770.18	4 421 278.1
88	956 242.57	4 415 481.96	148	955 205.74	4 417 801.87	208	954 769.88	4 421 275.92
89	956 261.83	4 415 565.33	149	955 182.44	4 417 889.77	209	954 772.16	4 421 275.64
90	956 259.64	4 415 564.65	150	955 180.22	4 417 889.17	210	954 772.44	4 421 277.82
91	956 260.29	4 415 562.55	151	955 180.79	4 417 887.05	211	954 781.26	4 421 366.11
92	956 262.49	4 415 563.22	152	955 183	4 417 887.63	212	954 780.98	4 421 363.92
93	956 235.68	4 415 650.86	153	955 082.87	4 418 755.6	213	954 783.27	4 421 363.64
94	956 233.49	4 415 649.41	154	955 080.45	4 418 758.82	214	954 783.53	4 421 365.83
95	956 234.14	4 415 647.3	155	955 078.03	4 418 757	215	954 794.39	4 421 449.28
96	956 236.33	4 415 647.98	156	955 079.77	4 418 754.64	216	954 794.27	4 421 450.46
97	956 217.87	4 415 705.24	157	955 078.72	4 418 748.87	217	954 791.26	4 421 450.46
98	956 215.99	4 415 703.63	158	955 081.69	4 418 746.46	218	954 791.38	4 421 449.21
99	956 217.31	4 415 701.84	159	954 881.9	4 420 357.69	219	954 791.24	4 421 448.09
100	956 219.34	4 415 703.44	160	954 879.61	4 420 357.48	220	954 794.24	4 421 448.07
101	956 175.81	4 415 726.59	161	954 879.8	4 420 355.3	221	954 785.55	4 421 538.7
102	956 177.23	4 415 729.23	162	954 882.09	4 420 355.5	222	954 783.26	4 421 538.48
103	956 171.52	4 415 732.57	163	954 874.53	4 420 441.45	223	954 783.47	4 421 536.3
104	956 170.01	4 415 729.98	164	954 872.24	4 420 441.24	224	954 785.76	4 421 536.5
105	955 430.48	4 417 124.76	165	954 872.44	4 420 439.05	225	954 777.17	4 421 627
106	955 433.39	4 417 125.52	166	954 874.73	4 420 439.26	226	954 774.88	4 421 626.79
107	955 432.64	4 417 128.35	167	954 867.16	4 420 525.25	227	954 775.08	4 421 624.6
108	955 430.29	4 417 125.49	168	954 864.87	4 420 525.04	228	954 777.38	4 421 624.81
109	955 407.23	4 417 222.22	169	954 865.07	4 420 522.85	229	954 787.38	4 421 702.01
110	955 403.14	4 417 221.12	170	954 867.35	4 420 523.06	230	954 770.4	4 421 702.01
111	955 404.73	4 417 215.13	171	954 857.36	4 420 606.47	231	954 770.28	4 421 703.24
112	955 408.84	4 417 216.22	172	954 860.3	4 420 607.11	232	954 770.44	4 421 704.43
113	955 367.53	4 417 232.87	173	954 860.18	4 420 608.39	233	954 767.44	4 421 704.47
114	955 368.68	4 417 235.65	174	954 859.84	4 420 609.6	234	954 767.27	4 421 703.2
115	955 366.38	4 417 236.55	175	954 856.91	4 420 608.99	235	954 779.53	4 421 792.4

Номер	X	Y	Номер	X	Y	Номер	X	Y
239	954 791.28	4 421 880.31	299	954 750.47	4 422 879.87	359	954 517.14	4 425 483.79
240	954 790.99	4 421 878.12	300	954 752.34	4 422 881.2	360	954 515.24	4 425 482.67
241	954 793.27	4 421 877.83	301	954 699.78	4 422 955.46	361	954 516.41	4 425 480.69
242	954 793.56	4 421 880.01	302	954 697.91	4 422 954.14	362	954 518.31	4 425 481.8
243	954 803.03	4 421 968.24	303	954 699.17	4 422 952.34	363	954 591.88	4 425 527.71
244	954 802.75	4 421 966.05	304	954 701.05	4 422 953.67	364	954 589.98	4 425 528.58
245	954 805.02	4 421 965.75	305	954 648.46	4 423 027.93	365	954 591.14	4 425 524.61
246	954 805.31	4 421 967.93	306	954 646.59	4 423 026.61	366	954 593.04	4 425 525.73
247	954 814.79	4 422 056.15	307	954 647.85	4 423 024.82	367	954 666.59	4 425 671.61
248	954 814.5	4 422 053.97	308	954 649.73	4 423 026.14	368	954 664.69	4 425 570.49
249	954 816.78	4 422 053.65	309	954 597.16	4 423 100.41	369	954 665.85	4 425 568.51
250	954 817.07	4 422 055.84	310	954 595.29	4 423 099.08	370	954 667.75	4 425 569.62
251	954 826.85	4 422 119.09	311	954 596.56	4 423 097.29	371	954 741.3	4 425 615.51
252	954 826.05	4 422 120.49	312	954 598.44	4 423 098.61	372	954 739.4	4 425 614.4
253	954 826.48	4 422 121.68	313	954 476.97	4 423 265.63	373	954 740.56	4 425 612.42
254	954 823.56	4 422 122.33	314	954 479.49	4 423 267.26	374	954 742.46	4 425 613.54
255	954 823.17	4 422 121.25	315	954 475.35	4 423 273.13	375	954 815.9	4 425 659.95
256	954 822.93	4 422 119.61	316	954 472.87	4 423 271.44	376	954 814	4 425 658.23
257	954 853.63	4 422 202.96	317	954 439.07	4 423 324.5	377	954 815.16	4 425 658.25
258	954 852.86	4 422 200.89	318	954 437.09	4 423 323.52	378	954 817.07	4 425 657.37
259	954 855.02	4 422 200.1	319	954 438.47	4 423 320.73	379	954 890.71	4 425 703.32
260	954 855.77	4 422 202.17	320	954 440.3	4 423 318	380	954 888.82	4 425 702.2
261	954 883.35	4 422 283.65	321	954 442.13	4 423 319.26	381	954 889.98	4 425 700.22
262	954 882.59	4 422 281.58	322	954 440.45	4 423 321.89	382	954 891.88	4 425 701.34
263	954 884.75	4 422 280.79	323	954 407.81	4 423 384.48	383	954 965.44	4 425 747.23
264	954 885.5	4 422 282.86	324	954 410.55	4 423 385.24	384	954 963.54	4 425 746.11
265	954 913.08	4 422 364.35	325	954 409.93	4 423 386.59	385	954 964.7	4 425 744.13
266	954 912.32	4 422 362.78	326	954 409.8	4 423 387.9	386	954 966.6	4 425 745.25
267	954 914.47	4 422 361.49	327	954 406.94	4 423 387.21	387	955 040.14	4 425 791.13
268	954 915.24	4 422 363.56	328	954 407.13	4 423 385.52	388	955 038.24	4 425 790.01
269	954 942.8	4 422 445.05	329	954 400.5	4 423 475.42	389	955 039.41	4 425 788.03
270	954 942.04	4 422 442.98	330	954 398.22	4 423 475.19	390	955 041.31	4 425 789.15
271	954 944.2	4 422 442.19	331	954 398.45	4 423 472.99	391	955 114.85	4 425 835.03
272	954 944.95	4 422 444.26	332	954 400.73	4 423 473.22	392	955 112.96	4 425 833.91
273	954 974.67	4 422 524.27	333	954 391.5	4 423 563.5	393	955 114.12	4 425 831.93
274	954 973.99	4 422 525.51	334	954 389.21	4 423 563.29	394	955 116.02	4 425 833.04
275	954 970.7	4 422 525.51	335	954 389.44	4 423 561.08	395	955 169.55	4 425 878.92
276	954 971.53	4 422 524.06	336	954 391.72	4 423 561.31	396	955 187.66	4 425 877.81
277	954 971.07	4 422 522.8	337	954 382.51	4 423 651.56	397	955 188.83	4 425 875.82
278	954 974.15	4 422 522.8	338	954 380.23	4 423 651.33	398	955 190.73	4 425 876.94
279	954 941.03	4 422 583.47	339	954 380.45	4 423 649.15	399	955 264.28	4 425 922.84
280	954 939.03	4 422 582.35	340	954 382.73	4 423 649.37	400	955 262.38	4 425 921.72
281	954 940.11	4 422 580.43	341	954 372.31	4 423 737.31	401	955 263.54	4 425 919.74
282	954 942.11	4 422 581.56	342	954 373.73	4 423 737.45	402	955 265.44	4 425 920.85
283	954 897.44	4 422 680.72	343	954 373.51	4 423 739.85	403	955 338.98	4 425 966.73
284	954 895.44	4 422 659.59	344	954 372.17	4 423 739.52	404	955 337.08	4 425 965.82
285	954 896.51	4 422 657.69	345	954 254.36	4 425 314.44	405	955 338.25	4 425 963.65
286	954 898.52	4 422 658.8	346	954 255.5	4 425 315.44	406	955 340.15	4 425 964.75
287	954 852.36	4 422 739.65	347	954 252.34	4 425 316.54	407	955 412.51	4 426 011.38
288	954 850.6	4 422 738.33	348	954 251.47	4 425 315.76	408	955 412.13	4 426 010.12
289	954 852.5	4 422 735.83	349	954 251.55	4 425 314.02	409	955 410.81	4 426 009.34
290	954 853.87	4 422 733.18	350	954 254.45	4 425 313.03	410	955 412.5	4 426 006.97
291	954 855.83	4 422 734.21	351	954 367.74	4 425 396.01	411	955 413.68	4 426 010.65
292	954 854.27	4 422 737.11	352	954 365.85	4 425 394.89	412	955 444.12	4 426 105.22
293	954 802.38	4 422 810.52	353	954 367.02	4 425 392.9	413	955 442.65	4 426 105.69
294	954 800.48	4 422 809.17	354	954 368.92	4 425 394.02	414	955 441.98	4 426 103.59
295	954 801.76	4 422 807.38	355	954 442.45	4 425 439.91	415	955 443.46	4 426 103.12

Номер	X	Y	Номер	X	Y	Номер	X	Y
419	955 474.74	4 426 200.26	479	955 571.85	4 427 433.91	539	955 031.53	4 428 528.51
420	955 502.83	4 426 296.09	480	955 569.06	4 427 432.89	540	954 979.73	4 428 600.8
421	955 502.17	4 426 294	481	955 569.5	4 427 431.47	541	954 977.86	4 428 599.46
422	955 504.35	4 426 293.3	482	955 544.84	4 427 519.75	542	954 979.14	4 428 597.67
423	955 505.01	4 426 295.4	483	955 542.85	4 427 519.07	543	954 981.01	4 428 599.01
424	955 532.94	4 426 381.3	484	955 543.3	4 427 516.97	544	954 929.2	4 428 671.29
425	955 532.28	4 426 389.19	485	955 545.49	4 427 517.64	545	954 927.33	4 428 669.96
426	955 534.46	4 426 388.5	486	955 518.1	4 427 605.89	546	954 928.6	4 428 668.17
427	955 535.12	4 426 390.6	487	955 615.91	4 427 605.21	547	954 930.47	4 428 669.5
428	955 563.02	4 426 486.49	488	955 518.56	4 427 603.12	548	954 878.68	4 428 741.79
429	955 562.38	4 426 484.39	489	955 518.76	4 427 603.79	549	954 876.81	4 428 740.45
430	955 564.55	4 426 483.7	490	955 491.37	4 427 692.04	550	954 878.08	4 428 738.66
431	955 565.23	4 426 485.8	491	955 489.17	4 427 691.37	551	954 879.95	4 428 739.99
432	955 593.11	4 426 581.69	492	955 489.82	4 427 689.27	552	954 828.14	4 428 812.28
433	955 582.45	4 426 579.59	493	955 492.02	4 427 689.94	553	954 826.28	4 428 810.94
434	955 594.64	4 426 578.9	494	955 464.64	4 427 778.2	554	954 827.56	4 428 809.15
435	955 595.31	4 426 581.01	495	955 462.44	4 427 777.53	555	954 829.43	4 428 810.49
436	955 623.21	4 426 676.89	496	955 463.08	4 427 775.43	556	954 777.61	4 428 882.77
437	955 622.55	4 426 674.78	497	955 465.29	4 427 776.1	557	954 775.75	4 428 881.43
438	955 624.74	4 426 674.11	498	955 437.9	4 427 864.35	558	954 777.02	4 428 879.65
439	955 625.4	4 426 676.21	499	955 435.71	4 427 863.68	559	954 776.89	4 428 880.99
440	955 653.3	4 426 772.09	500	955 438.38	4 427 861.58	560	954 727.09	4 428 953.28
441	955 652.64	4 426 769.99	501	955 438.55	4 427 862.24	561	954 725.22	4 428 951.94
442	955 654.84	4 426 769.3	502	955 411.16	4 427 950.5	562	954 726.5	4 428 950.14
443	955 655.5	4 426 771.41	503	955 408.97	4 427 949.83	563	954 728.37	4 428 951.49
444	955 683.4	4 426 867.29	504	955 409.62	4 427 947.73	564	954 677.75	4 429 022.76
445	955 682.73	4 426 865.2	505	955 411.81	4 427 948.4	565	954 677.56	4 429 024.28
446	955 684.92	4 426 864.5	506	955 382.83	4 428 033.4	566	954 674.72	4 429 023.51
447	955 685.58	4 426 866.6	507	955 385.38	4 428 034.48	567	954 675.03	4 429 021.34
448	955 713.49	4 426 962.5	508	955 384.89	4 428 036.03	568	954 675.71	4 429 020.38
449	955 712.82	4 426 960.4	509	955 384.18	4 428 037	569	954 678.74	4 429 021.37
450	955 715.01	4 426 959.71	510	955 381.36	4 428 035.83	570	954 666.87	4 429 110.93
451	955 715.67	4 426 961.81	511	955 382.25	4 428 034.63	571	954 664.59	4 429 110.66
452	955 745.35	4 427 054.77	512	955 333.43	4 428 107.34	572	954 664.84	4 429 108.47
453	955 745.83	4 427 056.37	513	955 331.56	4 428 105.99	573	954 667.13	4 429 108.74
454	955 745.53	4 427 057.7	514	955 332.85	4 428 104.21	574	954 656.47	4 429 198.42
455	955 742.42	4 427 057.93	515	955 334.72	4 428 105.54	575	954 654.18	4 429 198.16
456	955 742.78	4 427 056.38	516	955 282.9	4 428 177.83	576	954 654.44	4 429 195.96
457	955 742.35	4 427 054.99	517	955 281.03	4 428 176.48	577	954 656.72	4 429 196.24
458	955 728.72	4 427 129.17	518	955 282.32	4 428 174.69	578	954 646.05	4 429 285.91
459	955 726.47	4 427 126.65	519	955 284.18	4 428 176.04	579	954 643.77	4 429 285.65
460	955 726.97	4 427 128.51	520	955 232.36	4 428 248.32	580	954 644.04	4 429 283.46
461	955 729.21	4 427 127.02	521	955 230.5	4 428 248.98	581	954 648.32	4 429 283.74
462	955 710.26	4 427 197.38	522	955 231.77	4 428 245.19	582	954 633.32	4 429 370.19
463	955 713.06	4 427 198.33	523	955 233.64	4 428 246.53	583	954 636.24	4 429 370.79
464	955 712.63	4 427 200.13	524	955 181.83	4 428 318.82	584	954 636.02	4 429 372.63
465	955 711.84	4 427 201.45	525	955 179.96	4 428 317.47	585	954 635.55	4 429 373.92
466	955 709.05	4 427 200.29	526	955 181.25	4 428 315.68	586	954 632.63	4 429 373.19
467	955 709.94	4 427 198.8	527	955 183.12	4 428 317.03	587	954 833.14	4 429 371.77
468	955 664.92	4 427 278.51	528	955 131.31	4 428 389.3	588	954 605.1	4 429 455.35
469	955 662.95	4 427 277.32	529	955 129.44	4 428 387.97	589	954 602.94	4 429 454.55
470	955 664.08	4 427 275.43	530	955 130.73	4 428 386.17	590	954 603.71	4 429 452.49
471	955 666.05	4 427 278.63	531	955 132.59	4 428 387.51	591	954 605.86	4 429 453.29
472	955 618.07	4 427 358.12	532	955 080.78	4 428 459.81	592	954 574.84	4 429 537.1
473	955 616.1	4 427 354.94	533	955 078.92	4 428 458.46	593	954 572.69	4 429 536.3
474	955 617.23	4 427 353.06	534	955 080.19	4 428 456.67	594	954 573.45	4 429 534.24
475	955 619.21	4 427 354.24	535	955 082.06	4 428 458.02	595	954 575.61	4 429 535.03

Перечень координат поворотных точек
земельного участка 86:04:0000001:110005:3У2

Номер	X	Y
599	954 545.37	4 429 616.78
600	954 514.36	4 429 700.59
601	954 512.21	4 429 699.79
602	954 512.97	4 429 697.72
603	954 515.13	4 429 698.52
604	954 484.12	4 429 782.34
605	954 481.96	4 429 781.54
606	954 482.73	4 429 779.47
607	954 484.88	4 429 780.27
608	954 452.85	4 429 859.81
609	954 455.49	4 429 860.81
610	954 454.52	4 429 863.49
611	954 451.72	4 429 862.36
612	954 292.13	4 430 097.87
613	954 295.12	4 430 097.96
614	954 294.99	4 430 105.48
615	954 292.01	4 430 105.42
616	954 294.21	4 430 152.52
617	954 291.22	4 430 152.48
618	954 291.26	4 430 150.09
619	954 294.25	4 430 150.19
620	954 289.73	4 430 232.91
621	954 292.72	4 430 233.14
622	954 292.88	4 430 234.95
623	954 292.58	4 430 236.31
624	954 289.81	4 430 235.97
625	954 289.89	4 430 234.82
626	954 286.48	4 430 316.68
627	954 286.24	4 430 319.8
628	954 283.26	4 430 319.52
629	954 283.5	4 430 316.45
630	954 280.16	4 430 389.06
631	954 277.88	4 430 388.88
632	954 278.05	4 430 388.69
633	954 290.34	4 430 388.88
634	954 274.39	4 430 458.35
635	954 272.11	4 430 458.16
636	954 272.28	4 430 455.97
637	954 274.58	4 430 456.16
638	954 268.82	4 430 517.55
639	954 269.8	4 430 517.85
640	954 268.79	4 430 530.54
641	954 265.81	4 430 530.31
642	954 260.55	4 430 592.75
643	954 263.55	4 430 592.95
644	954 262.67	4 430 603.27
645	954 259.89	4 430 602.99
646	954 254.89	4 430 663.2
647	954 257.7	4 430 663.3
648	954 257.56	4 430 665.06
649	954 257.56	4 430 665.51
650	954 254.55	4 430 665.49
651	954 254.55	4 430 665.01
652	954 255.41	4 430 749.48
653	954 255.39	4 430 747.27
654	954 257.69	4 430 747.26
655	954 257.7	4 430 749.46

Перечень координат поворотных точек земельного участка 86:04:0000001:110005:3У2

Номер	X	Y	Номер	X	Y
1	956 274.58	4 415 594.73	61	956 369.57	4 415 135.32
2	956 261.84	4 415 591.66	62	956 367.33	4 415 134.82
3	956 250.22	4 415 588.41	63	956 367.81	4 415 132.87
4	956 241.61	4 415 585.87	64	956 370.05	4 415 133.17
5	956 246.14	4 415 583.96	65	956 350.09	4 415 221.86
6	956 250.06	4 415 550.8	66	956 347.85	4 415 221.35
7	956 256.19	4 415 552.7	67	956 348.34	4 415 219.21
8	956 272.91	4 415 498.82	68	956 350.57	4 415 219.72
9	956 265.5	4 415 499.15	69	956 330.64	4 415 308.36
10	956 277.34	4 415 460.49	70	956 328.39	4 415 307.85
11	956 285.79	4 415 460.14	71	956 328.88	4 415 305.7
12	956 303.07	4 415 392.49	72	956 331.12	4 415 306.21
13	956 491.89	4 414 564.68	73	956 310.54	4 415 396.88
14	956 483.08	4 414 260.99	74	956 308.41	4 415 395.31
15	956 605.25	4 413 996.77	75	956 309.21	4 415 393.33
16	956 621.57	4 413 997.53	76	956 309.88	4 415 390.34
17	956 606.25	4 414 030.13	77	956 312.03	4 415 390.82
18	956 590.25	4 414 064.59	78	956 311.34	4 415 393.88
19	956 497.63	4 414 264.07	79	956 287.37	4 415 482.5
20	956 505.94	4 414 556.04	80	956 283.16	4 415 481.19
21	956 317.34	4 415 394.18	81	956 284.86	4 415 475.35
22	956 265.76	4 415 572.41	82	956 289.1	4 415 476.49
23	956 271.31	4 415 574.11	83	956 243.27	4 415 479.08
24	956 280.1	4 415 576.84	84	956 244.55	4 415 479.57
25	956 274.58	4 415 594.73	85	956 245.69	4 415 479.52
26	956 259.84	4 415 564.65	86	956 245.25	4 415 482.51
27	956 260.29	4 415 562.55	87	956 244.1	4 415 482.56
28	956 262.49	4 415 563.22	88	956 242.57	4 415 481.96
29	956 603.71	4 414 021.81	89	956 261.83	4 415 565.33
30	956 601.82	4 414 020.83	90	956 259.84	4 415 564.65
31	956 602.56	4 414 018.84	91	956 260.29	4 415 562.55
32	956 604.63	4 414 019.8	92	956 262.49	4 415 563.22
33	956 287.37	4 415 482.5	93	956 235.88	4 415 650.08
34	956 283.16	4 415 481.19	94	956 233.49	4 415 649.41
35	956 284.86	4 415 475.35	95	956 234.14	4 415 647.3
36	956 289.1	4 415 476.49	96	956 236.33	4 415 647.98
37	956 566.34	4 414 102.25	97	956 217.87	4 415 705.24
38	956 564.26	4 414 101.29	98	956 215.99	4 415 703.63
39	956 565.19	4 414 099.28	99	956 217.31	4 415 701.84
40	956 567.28	4 414 100.26	100	956 218.34	4 415 703.44
41	956 310.54	4 415 396.88	101	956 175.81	4 415 728.59
42	956 308.41	4 415 396.31	102	956 177.23	4 415 729.23
43	956 309.21	4 415 393.33	103	956 171.52	4 415 732.67
44	956 309.88	4 415 390.34	104	956 170.01	4 415 729.98
45	956 312.03	4 415 390.82	105	956 430.48	4 417 124.76
46	956 311.34	4 415 393.88	106	956 433.39	4 417 125.52
47	956 528.97	4 414 182.7	107	956 432.64	4 417 128.35
48	956 528.89	4 414 181.73	108	956 430.29	4 417 125.49
49	956 527.82	4 414 179.74	109	956 407.23	4 417 222.22
50	956 529.9	4 414 180.69	110	956 403.14	4 417 221.12
51	956 330.64	4 415 308.36	111	956 404.73	4 417 215.13
52	956 328.39	4 415 307.85	112	956 408.84	4 417 216.22
53	956 328.88	4 415 305.7	113	956 367.53	4 417 232.87
54	956 331.12	4 415 306.21	114	956 368.68	4 417 235.65
55	956 489.32	4 414 271.2	115	956 366.38	4 417 236.55
56	956 489.11	4 414 263.72	116	956 365.17	4 417 233.8
57	956 489.07	4 414 262.35	117	956 365	4 417 306.13

Номер	X	Y	Номер	X	Y	Номер	X	Y
121	956 235.25	4 415 496.27	181	956 134.31	4 415 739.49	241	955 603.91	4 416 503.65
122	956 230.95	4 415 494.92	182	956 192.5	4 415 710.2	242	955 485.97	4 416 923.48
123	956 229.94	4 415 494.62	183	956 199.71	4 415 702.42	243	955 483.07	4 416 922.71
124	956 229.6	4 415 494.56	184	956 214.11	4 415 691.45	244	955 494.88	4 416 915.92
125	956 228.61	4 415 494.27	185	956 232.4	4 416 630.61	245	955 487.76	4 416 916.69
126	956 228.45	4 415 491.83	186	956 241.35	4 415 586.91	246	955 587.94	4 416 553.65
127	956 223.33	4 415 491.38	187	956 249.97	4 415 589.38	247	955 585.74	4 416 552.97
128	956 226.73	4 415 479.66	188	956 262.04	4 415 592.75	248	955 586.4	4 416 560.87
129	956 225.85	4 415 479.37	189	956 274.28	4 415 595.71	249	955 588.6	4 416 551.55
130	956 224.14	4 415 485.56	190	956 236.43	4 415 718.29	250	955 498.02	4 416 882.39
131	956 222.82	4 415 484.93	191	956 168.04	4 415 758.58	251	955 495.12	4 416 881.61
132	956 202.66	4 415 482.27	192	956 162.92	4 415 749.99	252	955 499.49	4 416 865.18
133	956 204.28	4 415 475.99	193	956 164.47	4 415 736.68	253	955 502.39	4 416 865.94
134	956 206.13	4 415 476.49	194	956 163.36	4 415 734.66	254	955 578.94	4 416 582.51
135	956 208.27	4 415 469.17	195	956 165.3	4 415 733.62	255	955 578.74	4 416 581.83
136	956 208.22	4 415 468.51	196	956 166.41	4 415 735.63	256	955 577.4	4 416 579.73
137	956 206.32	4 415 468.16	197	956 235.68	4 415 650.08	257	955 579.6	4 416 580.4
138	956 207.1	4 415 468.47	198	956 233.49	4 415 649.41	258	955 510.28	4 416 829.89
139	956 207.44	4 415 467.62	199	956 234.14	4 415 647.3	259	955 508.05	4 416 829.34
140	956 212.47	4 415 469.61	200	956 236.33	4 415 647.98	260	955 508.56	4 416 827.21
141	956 213.28	4 415 467.57	201	956 171.52	4 415 732.57	261	955 510.81	4 416 827.76
142	956 208.28	4 415 465.58	202	956 170.01	4 415 729.98	262	955 568.77	4 416 622.38
143	956 208.77	4 415 464.29	203	956 175.81	4 415 726.59	263	955 564.63	4 416 621.82
144	956 207.52	4 415 463.79	204	956 184.7	4 415 721.39	264	955 565.44	4 416 618.8
145	956 211.84	4 415 448.08	205	956 186.21	4 415 723.98	265	955 566.37	4 416 615.82
146	956 230.32	4 415 455.24	206	956 177.23	4 415 729.23	266	955 568.47	4 416 616.48
147	956 235.49	4 415 457.25	207	956 211.33	4 415 709.29	267	955 567.55	4 416 619.42
148	956 247.57	4 415 461.83	208	956 209.82	4 415 706.7	268	955 522.13	4 416 790.41
149	956 253.97	4 415 461.63	209	956 216.65	4 415 702.7	269	955 519.91	4 416 789.83
150	956 248.93	4 415 479.37	210	956 218.99	4 415 695.16	270	955 520.47	4 416 787.71
151	956 246.69	4 415 479.52	211	956 221.86	4 415 696.03	271	955 522.7	4 416 788.29
152	956 244.55	4 415 479.57	212	956 219.17	4 415 704.71	272	955 556.2	4 416 658.28
153	956 243.27	4 415 479.06	213	955 436.84	4 417 133.36	273	955 553.28	4 416 657.6
154	956 236.95	4 415 476.54	214	955 432.64	4 417 128.35	274	955 554.11	4 416 654.05
155	956 235.84	4 415 479.33	215	955 433.39	4 417 125.52	275	955 555.18	4 416 650.76
156	956 242.57	4 415 481.99	216	955 472.82	4 416 972.93	276	955 558.04	4 416 651.68
157	956 244.1	4 415 482.56	217	955 470.58	4 416 972.34	277	955 556.99	4 416 654.92
158	956 246.25	4 415 482.51	218	955 430.48	4 417 124.76	278	955 533.38	4 416 742.75
159	956 248.07	4 415 482.4	219	955 430.29	4 417 125.48	279	955 531.15	4 416 742.2
160	956 239.27	4 415 490.47	220	955 425.74	4 417 119.82	280	955 531.66	4 416 740.08
161	956 232.56	4 415 487.33	221	955 479.15	4 416 918.73	281	955 533.91	4 416 740.62
162	956 233.84	4 415 484.61	222	955 476.09	4 416 915.6	282	955 544.74	4 416 705.37
163	956 240.55	4 415 467.75	223	955 545.08	4 416 654.89	283	955 542.52	4 416 704.79
164	956 211.92	4 415 473.24	224	955 579.68	4 416 542.51	284	955 543.08	4 416 702.66
165	956 209.73	4 415 472.57	225	955 585.08	4 416 500.37	285	955 545.31	4 416 703.25
166	956 210.38	4 415 470.46	226	955 607.47	4 416 486.47	286	955 417.31	4 417 206.83
167	956 212.58	4 415 471.13	227	955 608.93	4 416 486.91	287	955 404.16	4 417 201.87
168	956 214.74	4 415 478.61	228	955 609.58	4 416 484.81	288	955 412.47	4 417 170.27
169	956 207.94	4 415 475.62	229	955 609.09	4 416 484.65	289	955 413.98	4 417 164.52
170	956 209.15	4 415 472.87	230	955 634.73	4 416 455.9	290	955 424.88	4 417 178.06
171	956 215.96	4 415 475.86	231	955 571.9	4 416 659.13	291	955 424.79	4 417 178.41
172	956 243.89	4 415 500.12	232	955 502.38	4 416 922.85	292	955 416.42	4 417 210.19
173	956 248.96	4 415 482.37	233	955 482.69	4 416 920.3	293	955 407.44	4 417 206.72
174	956 252.85	4 415 482.21	234	955 475.4	4 416 967.43	294	955 395.32	4 417 202.82
175	956 252.72	4 415 479.21	235	955 472.5	4 416 966.68	295	955 396.89	4 417 199.78
176	956 249.82	4 415 479.34	236	955 476.88	4 416 950.23	296	955 401.96	4 417 202.23
177	956 254.9	4 415 461.59	237	955 479.78	4 416 951	297	955 403.64	4 417 202.96

Номер	X	Y	Номер	X	Y	Номер	X	Y
301	955 370.9	4 417 241.76	361	955 331.9	4 417 257.12	421	955 203.51	4 417 801.28
302	955 357.6	4 417 247	362	955 325.93	4 417 259.48	422	955 205.74	4 417 801.87
303	955 360.13	4 417 239.02	363	955 299.56	4 417 512.06	423	955 248.91	4 417 640.29
304	955 366.38	4 417 238.55	364	955 325.32	4 417 458.27	424	955 248.02	4 417 639.51
305	955 368.68	4 417 235.65	365	955 305.49	4 417 448.75	425	955 247.86	4 417 632.57
306	955 372.48	4 417 234.15	366	955 328.69	4 417 400.34	426	955 248.23	4 417 631.19
307	955 371.38	4 417 231.35	367	955 334.02	4 417 380.82	427	955 248.65	4 417 630.27
308	955 367.53	4 417 232.87	368	955 336.38	4 417 371.88	428	955 251.87	4 417 623.3
309	955 365.17	4 417 233.8	369	955 353	4 417 375.32	429	955 254.59	4 417 624.56
310	955 361.3	4 417 235.33	370	955 393.82	4 417 381.68	430	955 251.52	4 417 631.2
311	955 361.42	4 417 234.96	371	955 383.29	4 417 420.62	431	955 251.07	4 417 632.16
312	955 365.64	4 417 214.85	372	955 357.79	4 417 473.82	432	955 250.73	4 417 633.45
313	955 369.26	4 417 213.86	373	955 342.71	4 417 466.59	433	955 227.9	4 417 718.23
314	955 379.74	4 417 204.49	374	955 337.95	4 417 464.31	434	955 225.68	4 417 717.63
315	955 382.06	4 417 204.9	375	955 316.17	4 417 509.77	435	955 226.24	4 417 715.5
316	955 385.5	4 417 205.73	376	955 324.79	4 417 472.17	436	955 228.48	4 417 718.1
317	955 390.51	4 417 206.48	377	955 322.7	4 417 471.21	437	955 061.4	4 418 794.1
318	955 403.01	4 417 209.82	378	955 323.64	4 417 469.22	438	955 064.83	4 418 785.76
319	955 410.09	4 417 212.31	379	955 325.72	4 417 470.19	439	955 074.03	4 418 753.21
320	955 424.43	4 417 218.61	380	955 359.16	4 417 398.81	440	955 070.1	4 418 724.56
321	955 361.13	4 417 289.95	381	955 356.44	4 417 397.58	441	955 072.59	4 418 704.02
322	955 407.23	4 417 222.22	382	955 359.36	4 417 391.24	442	955 078.72	4 418 746.87
323	955 403.14	4 417 221.12	383	955 359.95	4 417 389.95	443	955 079.77	4 418 754.64
324	955 404.73	4 417 215.13	384	955 360.24	4 417 388.87	444	955 078.02	4 418 757
325	955 408.84	4 417 216.22	385	955 362.11	4 417 381.87	445	955 075.09	4 418 760.96
326	955 344.54	4 417 252.14	386	955 365.01	4 417 382.63	446	955 077.5	4 418 762.74
327	955 356.06	4 417 215.87	387	955 363.13	4 417 389.7	447	955 080.45	4 418 758.82
328	955 356.69	4 417 215.92	388	955 362.78	4 417 390.99	448	955 082.87	4 418 755.6
329	955 352.64	4 417 233.12	389	955 362.22	4 417 392.21	449	955 081.69	4 418 746.46
330	955 347.22	4 417 251.09	390	955 162.83	4 417 986.78	450	955 074.01	4 418 692.2
331	955 396.61	4 417 371.29	391	955 180.25	4 417 874.8	451	955 076.71	4 418 669.95
332	955 392.69	4 417 370.76	392	955 184.82	4 417 845.12	452	955 088.67	4 418 756.92
333	955 372.04	4 417 367.62	393	955 196.61	4 417 800.59	453	954 357.22	4 423 980.59
334	955 350.7	4 417 364.46	394	955 221.46	4 417 706.82	454	954 367.71	4 423 810.16
335	955 339.18	4 417 361.55	395	955 218.88	4 417 706.17	455	954 372.17	4 423 739.53
336	955 355.72	4 417 298.8	396	955 224.43	4 417 683.84	456	954 373.51	4 423 739.65
337	955 361.66	4 417 280.97	397	955 217.92	4 417 682.23	457	954 373.73	4 423 737.45
338	955 425.43	4 417 219.01	398	955 226.65	4 417 646.63	458	954 372.31	4 423 737.31
339	955 433.72	4 417 222.07	399	955 231	4 417 632.11	459	954 386.14	4 423 518.58
340	955 433.21	4 417 224.81	400	955 240.25	4 417 600.7	460	954 399.77	4 423 381.67
341	955 436.44	4 417 225.42	401	955 253.91	4 417 607.39	461	954 399.96	4 423 379.75
342	955 385	4 417 306.13	402	955 292.72	4 417 526.35	462	954 403.02	4 423 348.98
343	955 382.78	4 417 305.53	403	955 309.38	4 417 523.96	463	954 421.4	4 423 310.71
344	955 383.35	4 417 303.41	404	955 268.53	4 417 613.45	464	954 425.67	4 423 313.34
345	955 385.56	4 417 304	405	955 271	4 417 615.75	465	954 424.61	4 423 306.23
346	955 324.44	4 417 259.54	406	955 284.45	4 417 622.34	466	954 454.98	4 423 264.32
347	955 325.32	4 417 256.57	407	955 264.69	4 417 662.7	467	954 464.29	4 423 270.85
348	955 325.56	4 417 256.68	408	955 257.45	4 417 692.01	468	954 470.38	4 423 262.24
349	955 325.44	4 417 257	409	955 243.93	4 417 888.87	469	954 471.08	4 423 262.75
350	955 327.42	4 417 257.88	410	955 238.03	4 417 887.23	470	954 544.44	4 423 159.56
351	955 327.43	4 417 257.83	411	955 182.44	4 417 889.77	471	954 571.88	4 423 120.62
352	955 327.45	4 417 257.84	412	955 180.22	4 417 889.17	472	954 641.61	4 423 021.74
353	955 328.03	4 417 256.45	413	955 180.79	4 417 887.05	473	954 744.22	4 422 876.79
354	955 325.65	4 417 255.46	414	955 183	4 417 887.63	474	954 840.59	4 422 732.22
355	955 326.6	4 417 252.24	415	955 287.51	4 417 552.65	475	954 933.6	4 422 578.03
356	955 332.69	4 417 249.82	416	955 285.43	4 417 551.68	476	954 937.15	4 422 569.68
357	955 331.59	4 417 247.02	417	955 286.36	4 417 549.69	477	954 950.14	4 422 528.96
358	955 327.69	4 417 248.58						

Номер	X	Y	Номер	X	Y	Номер	X	Y
481	954 940.7	4 422 472.84	541	954 879.8	4 420 355.3	601	954 506.49	4 423 229.18
482	954 939.68	4 422 470.02	542	954 882.09	4 420 355.5	602	954 504	4 423 227.51
483	954 859.38	4 422 247.62	543	954 391.5	4 423 563.5	603	954 513.86	4 423 213.61
484	954 816.78	4 422 133.77	544	954 389.21	4 423 563.29	604	954 516.34	4 423 215.29
485	954 819.04	4 422 127	545	954 389.44	4 423 561.08	605	954 788.99	4 420 856.32
486	954 814.86	4 422 126.67	546	954 391.72	4 423 561.31	606	954 786.78	4 420 855.69
487	954 814.74	4 422 128.36	547	954 874.53	4 420 441.45	607	954 787.39	4 420 853.57
488	954 814.17	4 422 124.67	548	954 872.24	4 420 441.24	608	954 789.6	4 420 854.2
489	954 817.11	4 422 123.59	549	954 872.44	4 420 439.05	609	954 541.92	4 423 179.1
490	954 796.15	4 421 968.05	550	954 874.73	4 420 439.26	610	954 539.43	4 423 177.43
491	954 772.81	4 421 792.21	551	954 400.5	4 423 475.42	611	954 549.2	4 423 163.5
492	954 761.22	4 421 706.7	552	954 398.22	4 423 475.19	612	954 553.43	4 423 157.65
493	954 763.58	4 421 703.2	553	954 398.45	4 423 472.99	613	954 555.95	4 423 159.28
494	954 760.81	4 421 703.64	554	954 400.73	4 423 473.22	614	954 551.69	4 423 165.17
495	954 768.16	4 421 625.05	555	954 867.16	4 420 525.25	615	954 764.61	4 420 941.6
496	954 784.65	4 421 450.34	556	954 864.87	4 420 525.04	616	954 762.4	4 420 940.97
497	954 783.76	4 421 450.38	557	954 865.07	4 420 522.85	617	954 763.01	4 420 938.85
498	954 776.05	4 421 451.34	558	954 867.35	4 420 523.06	618	954 765.21	4 420 939.47
499	954 760.8	4 421 328.71	559	954 409.11	4 423 394.71	619	954 597.16	4 423 100.41
500	954 768.52	4 421 327.72	560	954 406.13	4 423 394.41	620	954 595.29	4 423 099.08
501	954 730.61	4 421 027.48	561	954 406.94	4 423 387.21	621	954 596.56	4 423 097.29
502	954 733.8	4 421 023.98	562	954 407.13	4 423 385.52	622	954 598.44	4 423 098.61
503	954 731.55	4 421 024.05	563	954 407.61	4 423 384.48	623	954 739	4 421 034.14
504	954 756.14	4 420 938.04	564	954 410.7	4 423 377.8	624	954 738.1	4 421 026.79
505	954 804.86	4 420 767.45	565	954 413.41	4 423 379.06	625	954 737.93	4 421 025.42
506	954 850.87	4 420 606.64	566	954 410.55	4 423 385.24	626	954 738.27	4 421 024.22
507	954 865.51	4 420 439.55	567	954 409.93	4 423 385.59	627	954 740.34	4 421 016.9
508	954 873.1	4 420 353.5	568	954 409.8	4 423 387.9	628	954 743.22	4 421 017.73
509	954 898.58	4 420 257.59	569	954 857.86	4 420 616.62	629	954 741.35	4 421 024.22
510	954 887.62	4 420 609.68	570	954 854.97	4 420 615.81	630	954 740.95	4 421 025.63
511	954 748.59	4 421 028.2	571	954 856.91	4 420 608.99	631	954 741.1	4 421 026.79
512	954 786.39	4 421 325.47	572	954 857.25	4 420 607.78	632	954 741.97	4 421 033.76
513	954 793.38	4 421 324.59	573	954 857.36	4 420 606.47	633	954 648.46	4 423 027.93
514	954 808.83	4 421 447.22	574	954 857.98	4 420 599.45	634	954 646.59	4 423 026.61
515	954 801.87	4 421 450.05	575	954 880.97	4 420 599.71	635	954 647.85	4 423 024.82
516	954 777.82	4 421 703.02	576	954 860.3	4 420 607.11	636	954 649.73	4 423 026.14
517	954 799.64	4 421 866.81	577	954 860.18	4 420 608.39	637	954 747.95	4 421 102.11
518	954 802.61	4 421 866.4	578	954 859.84	4 420 609.6	638	954 747.87	4 421 099.93
519	954 821.62	4 422 005.59	579	954 439.07	4 423 324.5	639	954 749.96	4 421 099.64
520	954 818.65	4 422 006.05	580	954 437.09	4 423 323.52	640	954 750.23	4 421 101.83
521	954 833.39	4 422 116.68	581	954 438.47	4 423 320.73	641	954 699.78	4 422 955.46
522	954 890.33	4 422 164.61	582	954 440.3	4 423 318	642	954 697.91	4 422 954.14
523	954 856.61	4 422 162.3	583	954 442.13	4 423 319.26	643	954 699.17	4 422 952.34
524	954 862.53	4 422 160.12	584	954 440.45	4 423 321.69	644	954 701.05	4 422 953.67
525	954 993.82	4 422 516.54	585	954 837.73	4 420 685.72	645	954 759.05	4 421 190.11
526	954 981.02	4 422 528.58	586	954 835.53	4 420 685.09	646	954 758.78	4 421 187.92
527	954 861	4 422 741.25	587	954 836.13	4 420 682.97	647	954 761.05	4 421 187.63
528	954 478.92	4 423 281.31	588	954 838.34	4 420 683.6	648	954 761.33	4 421 189.83
529	954 480.92	4 423 282.73	589	954 471.33	4 423 278.83	649	954 751.07	4 422 882.99
530	954 489.46	4 423 288.78	590	954 468.83	4 423 277.16	650	954 749.19	4 422 881.67
531	954 458.54	4 423 332.39	591	954 472.87	4 423 271.44	651	954 750.47	4 422 879.87
532	954 428.33	4 423 395.63	592	954 476.97	4 423 265.63	652	954 752.34	4 422 881.2
533	954 421.63	4 423 392.43	593	954 478.39	4 423 263.62	653	954 770.16	4 421 278.1
534	954 417.1	4 423 390.27	594	954 480.88	4 423 265.29	654	954 769.88	4 421 275.92
535	954 382.51	4 423 651.66	595	954 479.49	4 423 267.26	655	954 772.16	4 421 275.64
536	954 380.23	4 423 651.33	596	954 475.35	4 423 273.13	656	954 772.44	4 421 277.82
537	954 380.45	4 423 649.15	597	954 813.35	4 420 771.01	657	954 802.36	4 422 810.52

Номер	X	Y	Номер	X	Y	Номер	X	Y
661	954 781.26	4 421 366.11	721	954 779.53	4 421 792.4	781	954 444.34	4 425 453.04
662	954 780.98	4 421 363.92	722	954 779.24	4 421 790.22	782	954 442.04	4 425 451.84
663	954 783.27	4 421 363.64	723	954 781.52	4 421 789.91	783	954 441.27	4 425 453.02
664	954 783.53	4 421 365.83	724	954 781.81	4 421 792.1	784	954 393.1	4 425 423.77
665	954 852.36	4 422 739.65	725	954 913.08	4 422 384.35	785	954 393.46	4 425 423.11
666	954 850.6	4 422 738.33	726	954 912.32	4 422 382.28	786	954 390.82	4 425 421.87
667	954 852.5	4 422 735.83	727	954 914.47	4 422 361.49	787	954 390.52	4 425 422.23
668	954 853.87	4 422 733.18	728	954 915.24	4 422 363.56	788	954 341.6	4 425 383.37
669	954 855.83	4 422 734.21	729	954 791.28	4 421 880.31	789	954 341.93	4 425 392.76
670	954 854.27	4 422 737.11	730	954 790.99	4 421 878.12	790	954 339.28	4 425 391.33
671	954 793.54	4 421 457.77	731	954 793.27	4 421 877.83	791	954 339.02	4 425 391.79
672	954 790.56	4 421 457.47	732	954 793.56	4 421 880.01	792	954 288.8	4 425 359.87
673	954 791.26	4 421 450.46	733	954 883.35	4 422 283.65	793	954 290.01	4 425 357.82
674	954 791.38	4 421 449.21	734	954 882.59	4 422 281.58	794	954 287.41	4 425 356.3
675	954 791.24	4 421 448.09	735	954 884.75	4 422 280.79	795	954 286.34	4 425 358.11
676	954 790.35	4 421 440.95	736	954 885.5	4 422 282.86	796	954 244.6	4 425 320.85
677	954 793.32	4 421 440.57	737	954 803.03	4 421 968.24	797	954 247.57	4 425 319.72
678	954 794.24	4 421 448.07	738	954 802.75	4 421 966.05	798	954 246.5	4 425 316.92
679	954 794.39	4 421 449.26	739	954 805.02	4 421 965.75	799	954 243.67	4 425 318
680	954 794.27	4 421 450.46	740	954 805.31	4 421 967.93	800	954 249.42	4 425 227.47
681	954 897.44	4 422 660.72	741	954 853.63	4 422 202.96	801	954 267.98	4 425 216.84
682	954 895.44	4 422 659.59	742	954 852.86	4 422 200.89	802	954 262.5	4 425 304.08
683	954 896.51	4 422 657.68	743	954 855.02	4 422 200.1	803	954 287.43	4 425 298.55
684	954 898.52	4 422 658.8	744	954 855.77	4 422 202.17	804	954 274.5	4 425 304.85
685	954 785.55	4 421 538.7	745	954 814.79	4 422 058.15	805	954 305.7	4 425 332.65
686	954 783.26	4 421 538.48	746	954 814.5	4 422 053.97	806	954 411.9	4 425 395.06
687	954 783.47	4 421 536.3	747	954 816.78	4 422 053.65	807	954 462.71	4 425 424.91
688	954 785.76	4 421 536.5	748	954 817.07	4 422 055.84	808	954 659.47	4 425 540.53
689	954 941.03	4 422 583.47	749	954 826.1	4 422 128.38	809	954 656.75	4 425 545.17
690	954 939.03	4 422 582.35	750	954 823.56	4 422 122.33	810	954 654.42	4 425 549.16
691	954 940.11	4 422 580.43	751	954 823.17	4 422 121.25	811	954 770.73	4 425 617.55
692	954 942.11	4 422 581.56	752	954 822.93	4 422 119.81	812	954 771.69	4 425 629.38
693	954 777.17	4 421 627	753	954 821.9	4 422 112.71	813	954 759.41	4 425 637.71
694	954 774.88	4 421 626.79	754	954 824.87	4 422 112.29	814	954 741.3	4 425 615.51
695	954 775.08	4 421 624.6	755	954 825.85	4 422 119.09	815	954 739.4	4 425 614.4
696	954 777.38	4 421 624.81	756	954 826.05	4 422 120.49	816	954 740.56	4 425 612.42
697	954 970.3	4 422 532.27	757	954 826.48	4 422 121.68	817	954 742.46	4 425 613.54
698	954 967.65	4 422 536.87	758	954 828.92	4 422 128.36	818	954 259.36	4 425 228.88
699	954 970.7	4 422 525.51	759	954 711.12	4 425 809.96	819	954 257.07	4 425 228.73
700	954 971.53	4 422 524.06	760	954 711.29	4 425 809.66	820	954 257.21	4 425 226.55
701	954 971.07	4 422 522.8	761	954 708.67	4 425 808.21	821	954 259.51	4 425 226.89
702	954 968.86	4 422 516.73	762	954 708.53	4 425 808.46	822	954 666.59	4 425 571.61
703	954 971.67	4 422 515.69	763	954 674.61	4 425 589.06	823	954 664.69	4 425 570.49
704	954 974.15	4 422 522.8	764	954 652.69	4 425 576.53	824	954 665.85	4 425 568.51
705	954 974.67	4 422 524.27	765	954 653.07	4 425 575.82	825	954 667.75	4 425 569.82
706	954 973.99	4 422 525.51	766	954 650.43	4 425 574.38	826	954 258.22	4 425 321.84
707	954 768.42	4 421 711.85	767	954 650.08	4 425 575.01	827	954 252.34	4 425 318.54
708	954 767.44	4 421 704.47	768	954 597.39	4 425 543.94	828	954 251.47	4 425 315.76
709	954 767.27	4 421 703.2	769	954 597.79	4 425 543.2	829	954 251.55	4 425 314.02
710	954 767.38	4 421 702.01	770	954 595.15	4 425 541.76	830	954 251.87	4 425 306.54
711	954 768.08	4 421 694.67	771	954 594.8	4 425 542.41	831	954 254.67	4 425 306.73
712	954 771.08	4 421 694.96	772	954 547.3	4 425 514.75	832	954 254.45	4 425 313.03
713	954 770.4	4 421 702.01	773	954 547.5	4 425 514.38	833	954 254.36	4 425 314.44
714	954 770.28	4 421 703.24	774	954 544.86	4 425 512.94	834	954 255.5	4 425 315.44
715	954 770.44	4 421 704.43	775	954 544.69	4 425 513.27	835	954 260.19	4 425 319.59
716	954 771.4	4 421 711.44	776	954 500.56	4 425 487.06	836	954 591.88	4 425 527.71
717	954 942.8	4 422 445.05	777	954 500.96	4 425 485.33	837	954 589.98	4 425 526.58

Номер	X	Y	Номер	X	Y	Номер	X	Y
841	954 291.73	4 425 351.62	901	955 326.63	4 428 101.1	961	954 472.3	4 429 848.12
842	954 289.07	4 425 349.32	902	955 376.4	4 428 031.58	962	954 484.12	4 429 782.34
843	954 291.07	4 425 347.08	903	955 402.75	4 427 946.74	963	954 481.96	4 429 781.54
844	954 293.56	4 425 349.3	904	955 456.22	4 427 774.44	964	954 482.73	4 429 779.47
845	954 296.41	4 425 351.01	905	955 509.68	4 427 602.14	965	954 484.88	4 429 780.27
846	954 517.14	4 425 483.79	906	955 562.82	4 427 430.9	966	954 815.9	4 425 659.35
847	954 515.24	4 425 482.67	907	955 563.56	4 427 431.14	967	954 814	4 425 658.23
848	954 516.41	4 425 480.69	908	955 564.51	4 427 428.29	968	954 815.18	4 425 658.25
849	954 518.31	4 425 481.8	909	955 563.92	4 427 428.09	969	954 817.07	4 425 657.37
850	954 367.74	4 425 396.01	910	955 610.79	4 427 350.46	970	954 514.38	4 429 700.59
851	954 365.85	4 425 394.89	911	955 703.86	4 427 196.3	971	954 512.21	4 429 699.79
852	954 367.02	4 425 392.9	912	955 736.04	4 427 056.66	972	954 512.97	4 429 697.72
853	954 368.92	4 425 394.02	913	955 678.52	4 426 868.31	973	954 515.13	4 429 698.52
854	954 442.45	4 425 439.91	914	955 616.34	4 426 677.9	974	954 890.71	4 425 703.32
855	954 440.55	4 425 438.79	915	955 526.07	4 426 392.31	975	954 888.82	4 425 702.2
856	954 441.71	4 425 436.81	916	955 465.87	4 426 201.9	976	954 889.98	4 425 700.22
857	954 443.61	4 425 437.92	917	955 406.6	4 426 014.45	977	954 891.88	4 425 701.34
858	954 452.53	4 429 867.8	918	955 334.58	4 425 972.08	978	954 544.61	4 429 618.85
859	954 452.09	4 429 867.81	919	955 014.35	4 425 783.91	979	954 542.45	4 429 618.05
860	954 454.52	4 429 863.49	920	955 013.1	4 425 786.05	980	954 543.22	4 429 615.98
861	954 455.49	4 429 860.81	921	954 787.27	4 425 654	981	954 545.37	4 429 616.78
862	954 457.46	4 429 855.34	922	954 802.16	4 425 643.87	982	954 965.44	4 425 747.23
863	954 454.66	4 429 854.34	923	954 801.46	4 425 635.64	983	954 963.54	4 425 746.11
864	954 452.65	4 429 859.81	924	955 408.86	4 425 995.87	984	954 964.7	4 425 744.13
865	954 451.72	4 429 862.36	925	955 408.94	4 425 995.92	985	954 966.6	4 425 745.25
866	954 449.29	4 429 866.41	926	955 412.5	4 426 006.96	986	954 574.84	4 429 537.1
867	954 440.61	4 429 862.79	927	955 406.76	4 426 003.44	987	954 572.69	4 429 538.3
868	954 450.63	4 429 837.49	928	955 405.23	4 426 006.02	988	954 573.45	4 429 534.24
869	954 448.96	4 429 836.88	929	955 410.81	4 426 009.34	989	954 575.61	4 429 535.03
870	954 479.32	4 429 755.32	930	955 412.13	4 426 010.12	990	955 040.14	4 425 791.13
871	954 489.86	4 429 727.01	931	955 412.51	4 426 011.38	991	955 038.24	4 425 790.01
872	954 610.61	4 429 402.52	932	955 414.43	4 426 017.61	992	955 039.41	4 425 788.03
873	954 622.6	4 429 372.77	933	955 415.79	4 426 017.19	993	955 041.31	4 425 789.15
874	954 622.88	4 429 372.84	934	955 443.46	4 426 103.12	994	954 605.1	4 429 455.35
875	954 623.58	4 429 369.91	935	955 441.98	4 426 103.59	995	954 602.94	4 429 454.55
876	954 623.18	4 429 369.82	936	955 442.65	4 426 105.69	996	954 603.71	4 429 452.49
877	954 631.35	4 429 308.05	937	955 444.12	4 426 105.22	997	954 605.86	4 429 453.29
878	954 638.91	4 429 239.84	938	955 474.06	4 426 198.17	998	955 114.85	4 425 835.03
879	954 646.35	4 429 174.32	939	955 472.09	4 426 198.79	999	955 112.96	4 425 833.91
880	954 653.58	4 429 113.63	940	955 472.76	4 426 200.89	1 000	955 114.12	4 425 831.93
881	954 659.81	4 429 064.06	941	955 474.74	4 426 200.27	1 001	955 116.02	4 425 833.04
882	954 665.03	4 429 018.37	942	955 752.22	4 427 062.17	1 002	954 633.08	4 429 380.86
883	954 668.26	4 429 018.94	943	955 752.09	4 427 062.78	1 003	954 630.28	4 429 379.86
884	954 668.78	4 429 015.98	944	955 719.8	4 427 202.74	1 004	954 632.63	4 429 373.19
885	954 666.11	4 429 015.51	945	955 579.08	4 427 435.87	1 005	954 633.14	4 429 371.77
886	954 696.57	4 428 973.25	946	955 391.8	4 428 039.32	1 006	954 633.32	4 429 370.19
887	954 696.84	4 428 972.87	947	954 989.28	4 428 600.92	1 007	954 634.08	4 429 363.67
888	954 728.51	4 428 928.93	948	954 991.41	4 428 602.44	1 008	954 637.08	4 429 364.09
889	954 766.46	4 428 876.1	949	954 997.4	4 428 606.72	1 009	954 636.24	4 429 370.79
890	954 803.14	4 428 825.31	950	954 961.1	4 428 657.44	1 010	954 636.02	4 429 372.63
891	954 806.13	4 428 821.03	951	954 955.07	4 428 653.14	1 011	954 635.55	4 429 373.92
892	954 838.58	4 428 775.95	952	954 952.96	4 428 651.63	1 012	955 189.55	4 425 878.92
893	954 877.92	4 428 720.94	953	954 686.46	4 429 023.36	1 013	955 187.66	4 425 877.81
894	954 916.11	4 428 667.59	954	954 689.87	4 429 023.76	1 014	955 188.83	4 425 875.82
895	954 957.51	4 428 609.74	955	954 695.15	4 429 024.38	1 015	955 190.73	4 425 876.94
896	954 972.45	4 428 588.87	956	954 670.63	4 429 232.47	1 016	954 646.05	4 429 285.91
897	954 974.65	4 428 590.43	957	954 665.12	4 429 231.85	1 017	954 643.77	4 429 285.65

Номер	X	Y	Номер	X	Y	Номер	X	Y
1 021	955 262.38	4 425 921.72	1 081	954 879.95	4 428 739.99	1 041	954 673.75	4 429 030.44
1 022	955 263.54	4 425 919.74	1 082	955 653.3	4 426 772.09	1 042	954 674.72	4 429 023.51
1 023	955 265.44	4 425 920.85	1 083	955 652.64	4 426 769.99	1 043	954 675.03	4 429 021.34
1 024	954 656.47	4 429 198.42	1 084	955 654.84	4 426 769.3	1 044	954 675.71	4 429 020.38
1 025	954 654.18	4 429 198.16	1 085	955 655.5	4 426 771.41	1 045	954 680	4 429 014.28
1 026	954 654.44	4 429 195.96	1 086	954 929.2	4 428 671.29	1 046	954 682.48	4 429 016.11
1 027	954 656.72	4 429 196.24	1 087	954 927.33	4 428 669.96	1 047	954 678.74	4 429 021.37
1 028	955 338.98	4 425 966.73	1 088	954 928.6	4 428 668.17	1 048	954 677.75	4 429 022.76
1 029	955 337.08	4 425 965.62	1 089	954 930.47	4 428 669.5	1 049	954 677.56	4 429 024.28
1 030	955 336.25	4 425 963.65	1 090	955 683.4	4 426 867.29	1 050	955 532.94	4 426 391.3
1 031	955 340.15	4 425 964.75	1 091	955 682.73	4 426 865.2	1 051	955 532.28	4 426 389.19
1 032	954 666.87	4 429 110.93	1 092	955 684.92	4 426 864.5	1 052	955 534.46	4 426 388.5
1 033	954 664.59	4 429 110.66	1 093	955 685.58	4 426 866.6	1 053	955 535.12	4 426 390.6
1 034	954 664.84	4 429 108.47	1 094	954 979.73	4 428 600.8	1 054	954 727.09	4 428 953.28
1 035	954 667.13	4 429 108.74	1 095	954 977.86	4 428 599.46	1 055	954 725.22	4 428 951.94
1 036	955 502.83	4 426 296.09	1 096	954 979.14	4 428 597.67	1 056	954 726.5	4 428 950.14
1 037	955 502.17	4 426 294	1 097	954 981.01	4 428 599.01	1 057	954 728.37	4 428 951.49
1 038	955 504.35	4 426 293.3	1 098	955 713.49	4 426 962.5	1 058	955 563.02	4 426 486.49
1 039	955 505.01	4 426 295.4	1 099	955 712.82	4 426 960.4	1 059	955 562.36	4 426 484.39
1 040	954 676.73	4 429 030.87	1 100	955 715.01	4 426 959.71	1 060	955 564.55	4 426 483.7
1 041	954 673.75	4 429 030.44	1 101	955 715.67	4 426 961.81	1 061	955 565.23	4 426 485.8
1 042	954 674.72	4 429 023.51	1 102	955 030.25	4 428 530.3	1 062	954 777.61	4 428 882.77
1 043	954 675.03	4 429 021.34	1 103	955 028.38	4 428 528.97	1 063	954 775.75	4 428 881.43
1 044	954 675.71	4 429 020.38	1 104	955 029.66	4 428 527.18	1 064	954 777.02	4 428 879.65
1 045	954 680	4 429 014.28	1 105	955 031.53	4 428 528.51	1 065	954 778.89	4 428 880.99
1 046	954 682.48	4 429 016.11	1 106	955 743.9	4 427 064.93	1 066	955 593.11	4 426 581.69
1 047	954 678.74	4 429 021.37	1 107	955 740.98	4 427 064.26	1 067	955 592.45	4 426 579.59
1 048	954 677.75	4 429 022.76	1 108	955 742.42	4 427 057.93	1 068	955 594.64	4 426 578.9
1 049	954 677.56	4 429 024.28	1 109	955 742.78	4 427 056.36	1 069	955 595.31	4 426 581.01
1 050	955 532.94	4 426 391.3	1 110	955 742.35	4 427 054.99	1 070	954 828.14	4 428 812.28
1 051	955 532.28	4 426 389.19	1 111	955 740.37	4 427 048.68	1 071	954 826.28	4 428 810.94
1 052	955 534.46	4 426 388.5	1 112	955 743.24	4 427 047.78	1 072	954 827.56	4 428 809.15
1 053	955 535.12	4 426 390.6	1 113	955 745.35	4 427 054.77	1 073	954 829.43	4 428 810.49
1 054	954 727.09	4 428 953.28	1 114	955 745.83	4 427 056.37	1 074	955 623.21	4 426 676.89
1 055	954 725.22	4 428 951.94	1 115	955 745.53	4 427 057.7	1 075	955 622.55	4 426 674.78
1 056	954 726.5	4 428 950.14	1 116	955 080.78	4 428 459.81	1 076	955 624.74	4 426 674.11
1 057	954 728.37	4 428 951.49	1 117	955 078.92	4 428 458.46	1 077	955 625.4	4 426 676.21
1 058	955 563.02	4 426 486.49	1 118	955 080.19	4 428 456.67	1 078	954 878.68	4 428 741.79
1 059	955 562.36	4 426 484.39	1 119	955 082.06	4 428 458.02	1 079	954 878.81	4 428 740.45
1 060	955 564.55	4 426 483.7	1 120	955 726.72	4 427 129.17	1 080	954 878.08	4 428 738.66
1 061	955 565.23	4 426 485.8	1 121	955 726.47	4 427 128.65	1 081	954 879.95	4 428 739.99
1 062	954 777.61	4 428 882.77	1 122	955 726.97	4 427 126.51	1 082	955 653.3	4 426 772.09
1 063	954 775.75	4 428 881.43	1 123	955 729.21	4 427 127.02	1 083	955 652.64	4 426 769.99
1 064	954 777.02	4 428 879.65	1 124	955 131.31	4 428 389.3	1 084	955 654.84	4 426 769.3
1 065	954 778.89	4 428 880.99	1 125	955 129.44	4 428 387.97	1 085	955 655.5	4 426 771.41
1 066	955 593.11	4 426 581.69	1 126	955 130.73	4 428 386.17	1 086	954 929.2	4 428 671.29
1 067	955 592.45	4 426 579.59	1 127	955 132.59	4 428 387.51	1 087	954 927.33	4 428 669.96
1 068	955 594.64	4 426 578.9	1 128	955 708.28	4 427 207.38	1 088	954 928.6	4 428 668.17
1 069	955 595.31	4 426 581.01	1 129	955 705.71	4 427 205.82	1 089	954 930.47	4 428 669.5
1 070	954 828.14	4 428 812.28	1 130	955 709.05	4 427 200.29	1 090	955 683.4	4 426 867.29
1 071	954 826.28	4 428 810.94	1 131	955 709.94	4 427 198.8	1 091	955 682.73	4 426 865.2
1 072	954 827.56	4 428 809.15	1 132	955 710.26	4 427 197.38	1 092	955 684.92	4 426 864.5
1 073	954 829.43	4 428 810.49	1 133	955 711.77	4 427 190.74	1 093	955 685.58	4 426 866.6
1 074	955 623.21	4 426 676.89	1 134	955 714.7	4 427 191.41	1 094	954 979.73	4 428 600.8
1 075	955 622.55	4 426 674.78	1 135	955 713.06	4 427 198.33	1 095	954 977.86	4 428 599.48
1 076	955 624.74	4 426 674.11	1 136	955 712.63	4 427 200.13	1 096	954 979.14	4 428 597.67
1 077	955 625.4	4 426 676.21	1 137	955 711.84	4 427 201.45	1 097	954 981.01	4 428 599.01

Номер	X	Y	Номер	X	Y	Номер	X	Y
1 001	955 116.02	4 425 833.04	1 061	955 585.23	4 426 485.8	1 121	955 726.47	4 427 128.65
1 002	954 633.08	4 429 380.66	1 062	954 777.61	4 428 882.77	1 122	955 726.97	4 427 126.51
1 003	954 630.28	4 429 379.66	1 063	954 775.75	4 428 881.43	1 123	955 729.21	4 427 127.02
1 004	954 632.63	4 429 373.19	1 064	954 777.02	4 428 879.65	1 124	955 131.31	4 428 389.3
1 005	954 633.14	4 429 371.77	1 065	954 778.89	4 428 880.99	1 125	955 129.44	4 428 387.97
1 006	954 633.32	4 429 370.19	1 066	955 593.11	4 426 581.69	1 126	955 130.73	4 428 386.17
1 007	954 634.08	4 429 363.67	1 067	955 592.45	4 426 579.59	1 127	955 132.59	4 428 387.51
1 008	954 637.06	4 429 364.09	1 068	955 594.64	4 426 578.9	1 128	955 708.28	4 427 207.38
1 009	954 636.24	4 429 370.79	1 069	955 595.31	4 426 581.01	1 129	955 705.71	4 427 205.82
1 010	954 636.02	4 429 372.63	1 070	954 828.14	4 428 812.28	1 130	955 709.05	4 427 200.29
1 011	954 635.55	4 429 373.92	1 071	954 826.28	4 428 810.94	1 131	955 709.94	4 427 198.8
1 012	955 189.55	4 425 878.92	1 072	954 827.56	4 428 809.15	1 132	955 710.26	4 427 197.38
1 013	955 187.66	4 425 877.81	1 073	954 829.43	4 428 810.49	1 133	955 711.77	4 427 190.74
1 014	955 188.83	4 425 875.82	1 074	955 623.21	4 426 676.89	1 134	955 714.7	4 427 191.41
1 015	955 190.73	4 425 876.94	1 075	955 622.55	4 426 674.78	1 135	955 713.06	4 427 198.33
1 016	954 646.05	4 429 285.91	1 076	955 624.74	4 426 674.11	1 136	955 712.63	4 427 200.13
1 017	954 643.77	4 429 285.65	1 077	955 625.4	4 426 676.21	1 137	955 711.84	4 427 201.45
1 018	954 644.04	4 429 283.48	1 078	954 878.68	4 428 741.79	1 138	955 181.83	4 428 318.82
1 019	954 646.32	4 429 283.74	1 079	954 876.81	4 428 740.45	1 139	955 179.96	4 428 317.47
1 020	955 264.28	4 425 922.84	1 080	954 878.08	4 428 738.66	1 140	955 181.25	4 428 315.68
1 021	955 262.38	4 425 921.72	1 081	954 879.95	4 428 739.99	1 141	955 183.12	4 428 317.03
1 022	955 263.54	4 425 919.74	1 082	955 653.3	4 426 772.09	1 142	955 664.82	4 427 278.51
1 023	955 265.44	4 425 920.65	1 083	955 652.64	4 426 769.99	1 143	955 662.95	4 427 277.32
1 024	954 656.47	4 429 198.42	1 084	955 654.84	4 426 769.3	1 144	955 664.08	4 427 275.43
1 025	954 654.18	4 429 198.16	1 085	955 655.5	4 426 771.41	1 145	955 666.05	4 427 276.63
1 026	954 654.44	4 429 195.96	1 086	954 929.2	4 428 671.29	1 146	955 232.36	4 428 248.32
1 027	954 656.72	4 429 196.24	1 087	954 927.33	4 428 669.96	1 147	955 230.5	4 428 246.98
1 028	955 338.98	4 425 966.73	1 088	954 928.6	4 428 668.17	1 148	955 231.77	4 428 245.19
1 029	955 337.08	4 425 965.62	1 089	954 930.47	4 428 669.5	1 149	955 233.64	4 428 246.53
1 030	955 338.25	4 425 963.65	1 090	955 683.4	4 426 867.29	1 150	955 618.07	4 427 356.12
1 031	955 340.15	4 425 964.75	1 091	955 682.73	4 426 865.2	1 151	955 616.1	4 427 354.94
1 032	954 666.87	4 429 110.93	1 092	955 684.92	4 426 864.5	1 152	955 617.23	4 427 353.06
1 033	954 664.59	4 429 110.66	1 093	955 685.58	4 428 866.6	1 153	955 619.21	4 427 354.24
1 034	954 664.84	4 429 108.47	1 094	954 979.73	4 428 600.8	1 154	955 282.9	4 428 177.83
1 035	954 667.13	4 429 108.74	1 095	954 977.86	4 428 599.46	1 155	955 281.03	4 428 176.48
1 036	955 502.83	4 426 296.09	1 096	954 979.14	4 428 597.67	1 156	955 282.32	4 428 174.69
1 037	955 502.17	4 426 294	1 097	954 981.01	4 428 599.01	1 157	955 284.18	4 428 176.04
1 038	955 504.35	4 426 293.3	1 098	955 713.49	4 426 982.5	1 158	955 569.81	4 427 440.66
1 039	955 505.01	4 426 295.4	1 099	955 712.82	4 426 960.4	1 159	955 566.94	4 427 439.77
1 040	954 676.73	4 429 030.87	1 100	955 715.01	4 426 959.71	1 160	955 569.06	4 427 432.89
1 041	954 673.75	4 429 030.44	1 101	955 715.67	4 426 961.81	1 161	955 569.5	4 427 431.47
1 042	954 674.72	4 429 023.51	1 102	955 030.25	4 428 530.3	1 162	955 570.29	4 427 430.15
1 043	954 675.03	4 429 021.34	1 103	955 028.38	4 428 528.97	1 163	955 573.89	4 427 424.15
1 044	954 675.71	4 429 020.38	1 104	955 029.66	4 428 527.18	1 164	955 576.46	4 427 425.68
1 045	954 680	4 429 014.28	1 105	955 031.53	4 428 528.51	1 165	955 573.05	4 427 431.38
1 046	954 682.48	4 429 016.11	1 106	955 743.9	4 427 064.93	1 166	955 572.18	4 427 432.62
1 047	954 678.74	4 429 021.37	1 107	955 740.98	4 427 064.26	1 167	955 571.85	4 427 433.91
1 048	954 677.75	4 429 022.76	1 108	955 742.42	4 427 057.93	1 168	955 333.43	4 428 107.34
1 049	954 677.56	4 429 024.28	1 109	955 742.78	4 427 058.36	1 169	955 331.56	4 428 105.99
1 050	955 532.94	4 426 391.3	1 110	955 742.35	4 427 054.99	1 170	955 332.85	4 428 104.21
1 051	955 532.28	4 426 389.19	1 111	955 740.37	4 427 048.68	1 171	955 334.72	4 428 105.54
1 052	955 534.46	4 426 388.5	1 112	955 743.24	4 427 047.78	1 172	955 544.84	4 427 519.75
1 053	955 535.12	4 426 390.6	1 113	955 745.35	4 427 054.77	1 173	955 542.85	4 427 519.07
1 054	954 727.09	4 428 953.28	1 114	955 745.83	4 427 056.37	1 174	955 543.3	4 427 516.97
1 055	954 725.22	4 428 951.94	1 115	955 745.53	4 427 057.7	1 175	955 545.49	4 427 517.64
1 056	954 726.5	4 428 950.14	1 116	955 080.78	4 428 459.81	1 176	955 379.86	4 428 042.95
1 057	954 728.37	4 428 951.49	1 117	955 078.92	4 428 458.46	1 177	955 377.37	4 428 041.13

Номер	X	Y	Номер	X	Y	Номер	X	Y
1 181	955 384.75	4 428 026.59	1 241	954 290.2	4 430 208.64	1 301	954 254.55	4 430 665.01
1 182	955 387.56	4 428 027.58	1 242	954 293.19	4 430 208.78	1 302	954 254.69	4 430 663.2
1 183	955 385.38	4 428 034.48	1 243	954 293.25	4 430 205.38	1 303	954 255.23	4 430 656.42
1 184	955 384.89	4 428 036.03	1 244	954 302.9	4 430 205.28	1 304	954 258.23	4 430 656.6
1 185	955 384.18	4 428 037	1 245	954 304.87	4 430 234.33	1 305	954 257.7	4 430 663.3
1 186	955 518.1	4 427 605.89	1 246	954 304.82	4 430 236.63	1 306	954 257.56	4 430 665.06
1 187	955 515.91	4 427 605.21	1 247	954 280.18	4 430 389.06	1 307	954 257.56	4 430 665.51
1 188	955 516.56	4 427 603.12	1 248	954 277.88	4 430 388.88	1 308	954 257.59	4 430 673.47
1 189	955 518.76	4 427 603.79	1 249	954 278.05	4 430 386.69	1 309	954 262.11	4 430 609.91
1 190	955 411.16	4 427 850.5	1 250	954 280.34	4 430 386.88	1 310	954 259.12	4 430 609.72
1 191	955 408.97	4 427 949.83	1 251	954 292.61	4 430 216.71	1 311	954 259.69	4 430 602.99
1 192	955 409.62	4 427 947.73	1 252	954 291.75	4 430 216.7	1 312	954 260.55	4 430 592.75
1 193	955 411.81	4 427 948.4	1 253	954 291.75	4 430 216.7	1 313	954 265.81	4 430 530.31
1 194	955 491.37	4 427 692.04	1 254	954 290.32	4 430 216.68	1 314	954 268.82	4 430 517.55
1 195	955 489.17	4 427 691.37	1 255	954 290.36	4 430 214.48	1 315	954 267.15	4 430 513.38
1 196	955 489.82	4 427 689.27	1 256	954 292.66	4 430 214.53	1 316	954 270.14	4 430 513.57
1 197	955 492.02	4 427 689.94	1 257	954 285.68	4 430 327.19	1 317	954 269.8	4 430 517.85
1 198	955 437.9	4 427 864.35	1 258	954 282.69	4 430 327.05	1 318	954 268.79	4 430 530.54
1 199	955 435.71	4 427 863.68	1 259	954 283.26	4 430 319.52	1 319	954 263.55	4 430 592.95
1 200	955 436.36	4 427 861.58	1 260	954 283.5	4 430 318.45	1 320	954 262.67	4 430 603.27
1 201	955 438.55	4 427 862.24	1 261	954 283.98	4 430 310.09			
1 202	955 464.64	4 427 778.2	1 262	954 286.97	4 430 310.23			
1 203	955 462.44	4 427 777.53	1 263	954 286.48	4 430 316.68			
1 204	955 463.08	4 427 775.43	1 264	954 286.24	4 430 319.8			
1 205	955 465.29	4 427 776.1	1 265	954 292.07	4 430 243.37			
1 206	954 430.32	4 429 889.87	1 266	954 289.09	4 430 243.23			
1 207	954 440.09	4 429 864.67	1 267	954 289.61	4 430 235.89			
1 208	954 448.24	4 429 868.14	1 268	954 289.66	4 430 234.82			
1 209	954 447.63	4 429 869.18	1 269	954 289.73	4 430 232.91			
1 210	954 449.82	4 429 870.47	1 270	954 289.87	4 430 226.38			
1 211	954 280.88	4 430 135.65	1 271	954 292.86	4 430 226.51			
1 212	954 282.79	4 430 036.53	1 272	954 292.72	4 430 233.14			
1 213	954 291.07	4 430 029.11	1 273	954 292.68	4 430 234.95			
1 214	954 298.21	4 430 134.65	1 274	954 272.28	4 430 781.04			
1 215	954 294.89	4 430 110.87	1 275	954 243.86	4 430 779.66			
1 216	954 291.92	4 430 110.73	1 276	954 244.81	4 430 632.09			
1 217	954 292.01	4 430 105.42	1 277	954 248.7	4 430 631.61			
1 218	954 292.13	4 430 097.87	1 278	954 248.36	4 430 628.64			
1 219	954 292.2	4 430 093.86	1 279	954 244.96	4 430 629.08			
1 220	954 296.19	4 430 094	1 280	954 249.6	4 430 572.66			
1 221	954 296.12	4 430 097.96	1 281	954 250.49	4 430 561.78			
1 222	954 294.99	4 430 105.48	1 282	954 260.86	4 430 435.63			
1 223	954 299.49	4 430 153.82	1 283	954 286.14	4 430 438.8			
1 224	954 294.18	4 430 154.27	1 284	954 278.7	4 430 462.9			
1 225	954 294.21	4 430 152.52	1 285	954 284.36	4 430 479.51			
1 226	954 294.25	4 430 150.19	1 286	954 279.75	4 430 539.49			
1 227	954 294.36	4 430 143.88	1 287	954 278.93	4 430 550.15			
1 228	954 291.37	4 430 143.75	1 288	954 270.07	4 430 665.37			
1 229	954 291.26	4 430 150.09	1 289	954 270.59	4 430 708.88			
1 230	954 291.22	4 430 152.48	1 290	954 271.86	4 430 708.91			
1 231	954 291.18	4 430 154.64	1 291	954 255.41	4 430 749.48			
1 232	954 280.49	4 430 155.94	1 292	954 256.39	4 430 747.27			
1 233	954 280.8	4 430 139.66	1 293	954 257.69	4 430 747.26			
1 234	954 298.48	4 430 138.66	1 294	954 257.7	4 430 749.46			
1 235	954 290.42	4 430 405.9	1 295	954 274.39	4 430 458.35			
1 236	954 283.64	4 430 401.87	1 296	954 272.11	4 430 458.16			
1 237	954 275.58	4 430 243.28	1 297	954 272.28	4 430 455.97			

Номер	X	Y	Номер	X	Y	Номер	X	Y
1	984 218.67	4 443 256.34	61	984 041.67	4 443 288.89	121	984 263.09	4 443 250.01
2	984 194.72	4 443 251.9	62	984 045.08	4 443 279.78	122	984 267.74	4 443 244.72
3	984 194.6	4 443 252.54	63	984 053.17	4 443 258.16	123	984 268.31	4 443 244.3
4	984 119.61	4 443 238.51	64	984 064.04	4 443 229.13	124	984 269.52	4 443 243.54
5	984 112.03	4 443 240.79	65	984 088.34	4 443 221.85	125	984 278.2	4 443 237.51
6	984 109.93	4 443 237.49	66	984 098.86	4 443 252.8	126	984 280.1	4 443 237.11
7	984 104.48	4 443 229.47	67	984 090.37	4 443 255.33	127	984 282.52	4 443 238.21
8	984 100.21	4 443 218.23	68	984 089.85	4 443 255.36	128	984 282.53	4 443 238.2
9	984 118.02	4 443 212.83	69	984 088.52	4 443 248.3	129	984 289.31	4 443 241.31
10	984 220.88	4 443 232	70	984 085.02	4 443 248.94	130	984 297.07	4 443 250.67
11	984 227.02	4 443 233.15	71	984 084.85	4 443 248.28	131	984 296.17	4 443 250.6
12	984 242.52	4 443 236.03	72	984 081.27	4 443 246.19	132	984 296.05	4 443 251.62
13	984 245.89	4 443 236.66	73	984 081.47	4 443 249.57	133	984 299.61	4 443 252.27
14	984 244.8	4 443 244.93	74	984 080.71	4 443 249.71	134	984 299.85	4 443 251.25
15	984 238.38	4 443 247.73	75	984 081.91	4 443 256.32	135	984 298.85	4 443 250.92
16	984 237.2	4 443 244.98	76	984 084.98	4 443 255.77	136	984 299	4 443 248.99
17	984 233.49	4 443 246.58	77	984 084.98	4 443 263.62	137	984 297.99	4 443 248.91
18	984 234.67	4 443 249.34	78	984 087.96	4 443 263.62	138	984 297.87	4 443 249.98
19	984 203.81	4 443 246.61	79	984 087.52	4 443 269.47	139	984 294.63	4 443 246.07
20	984 201.55	4 443 246.23	80	984 081.53	4 443 270.52	140	984 310.36	4 443 248.99
21	984 201.87	4 443 244.05	81	984 081.53	4 443 270.54	141	984 318.3	4 443 260.94
22	984 204.16	4 443 244.4	82	984 081.51	4 443 270.55	142	984 285.41	4 443 261.61
23	984 115.09	4 443 228.94	83	984 082.67	4 443 275.59	143	984 283.16	4 443 261.23
24	984 114.85	4 443 222.93	84	984 082.44	4 443 276.45	144	984 283.48	4 443 259.05
25	984 120.87	4 443 222.65	85	984 078.87	4 443 276.82	145	984 285.76	4 443 259.4
26	984 121.11	4 443 228.66	86	984 079.26	4 443 279.89	146	984 293.45	4 443 260.33
27	984 175.45	4 443 238.29	87	984 080.71	4 443 279.89	147	984 293.39	4 443 257.32
28	984 175.39	4 443 235.28	88	984 081.55	4 443 283.3	148	984 297.41	4 443 257.17
29	984 179.4	4 443 235.13	89	984 082.87	4 443 291	149	984 297.48	4 443 260.17
30	984 179.46	4 443 238.14	90	984 054	4 443 298.1	150	984 232.84	4 443 258.97
31	984 119.75	4 443 231.34	91	984 052.64	4 443 292.23	151	984 220.61	4 443 256.71
32	984 119.33	4 443 229.18	92	984 046.83	4 443 293.69	152	984 246.77	4 443 245.3
33	984 121.59	4 443 228.75	93	984 048.18	4 443 299.51	153	984 252.53	4 443 246.36
34	984 122	4 443 230.84	94	983 842.19	4 443 348.55	154	984 251.76	4 443 247.21
35	984 099.89	4 443 252.51	95	983 841.77	4 443 346.39	155	984 236.89	4 443 257.32
36	984 089.36	4 443 221.53	96	983 844.03	4 443 345.96	156	984 235.87	4 443 257.89
37	984 093.8	4 443 220.18	97	983 844.44	4 443 348.16	157	984 235.44	4 443 257.24
38	984 104.28	4 443 247.68	98	984 073.03	4 443 243.61	158	984 238.67	4 443 260.06
39	984 105.65	4 443 250.67	99	984 072.8	4 443 242.44	159	984 236.5	4 443 259.65
40	984 025.36	4 443 305.15	100	984 069.17	4 443 242.58	160	984 236.83	4 443 259.44
41	983 884.93	4 443 338.98	101	984 068.93	4 443 236.56	161	984 236.82	4 443 259.43
42	983 884.31	4 443 338.04	102	984 074.95	4 443 236.28	162	984 236.85	4 443 259.41
43	983 880.4	4 443 336.95	103	984 075.19	4 443 242.35	163	984 236.43	4 443 258.77
44	983 881.01	4 443 339.83	104	984 075.12	4 443 242.35	164	984 237.41	4 443 258.1
45	983 778.96	4 443 364.52	105	984 075.28	4 443 243.21	165	984 252.4	4 443 247.94
46	983 778.56	4 443 362.37	106	983 917.88	4 443 329.84	166	984 253.65	4 443 246.57
47	983 776.3	4 443 362.8	107	983 917.46	4 443 327.88	167	984 257.33	4 443 247.25
48	983 776.74	4 443 365.05	108	983 919.72	4 443 327.25	168	984 254.97	4 443 249.13
49	983 719.33	4 443 378.89	109	983 920.13	4 443 329.45	169	984 245.05	4 443 258.73
50	983 717.19	4 443 379.4	110	984 068.67	4 443 292.35	170	984 489.92	4 443 482.56
51	983 716.27	4 443 375.52	111	984 068.25	4 443 290.19	171	984 488.54	4 443 480.42
52	983 710.45	4 443 376.93	112	984 070.51	4 443 289.76	172	984 480.3	4 443 480.38
53	983 710.82	4 443 376.45	113	984 070.92	4 443 291.96	173	984 490.13	4 443 477.37
54	983 709.62	4 443 376.72	114	983 993.67	4 443 311.05	174	984 486.65	4 443 477.51
55	983 710.19	4 443 381.06	115	983 993.25	4 443 308.89	175	984 456.53	4 443 430.89
56	983 695.17	4 443 384.63	116	983 995.51	4 443 308.46	176	984 456.28	4 443 426.64
57	983 695.31	4 443 382.82	117	983 995.92	4 443 310.66	177	984 453.86	4 443 426.76

Номер	X	Y	Номер	X	Y	Номер	X	Y
181	984 420.45	4 443 375.05	241	982 905.29	4 443 550.98	301	982 888.33	4 443 552.53
182	984 387.72	4 443 324.4	242	982 901.38	4 443 551.83	302	982 890.59	4 443 552.1
183	984 389.61	4 443 324.35	243	982 901.99	4 443 554.78	303	982 891	4 443 554.29
184	984 389.43	4 443 321.34	244	982 806.83	4 443 574.91	304	983 456.51	4 443 431
185	984 385.83	4 443 321.48	245	982 601.5	4 443 618.36	305	983 456.09	4 443 428.84
186	984 390.8	4 443 282.73	246	982 533.79	4 443 635.26	306	983 458.35	4 443 428.41
187	984 336.44	4 443 278.21	247	982 533.47	4 443 633.79	307	983 458.76	4 443 430.6
188	984 322.59	4 443 257.57	248	982 531.23	4 443 634.28	308	982 962.43	4 443 538.54
189	984 317.7	4 443 250.09	249	982 531.57	4 443 635.81	309	982 962.01	4 443 536.38
190	984 362.7	4 443 256.55	250	981 893.01	4 443 795.1	310	982 964.27	4 443 535.95
191	984 367.79	4 443 266.74	251	981 892.84	4 443 794.33	311	982 964.68	4 443 538.15
192	984 431.96	4 443 369.85	252	981 890.6	4 443 794.82	312	983 427.67	4 443 440.48
193	984 464.92	4 443 422.81	253	981 890.78	4 443 795.64	313	983 427.61	4 443 437.48
194	984 494.88	4 443 465.86	254	981 829.09	4 443 810.5	314	983 431.51	4 443 437.38
195	984 452.3	4 443 411.7	255	981 828.79	4 443 809.15	315	983 431.68	4 443 440.34
196	984 451.21	4 443 409.79	256	981 798.37	4 443 816.69	316	983 036.28	4 443 522.57
197	984 453.22	4 443 408.66	257	981 794.16	4 443 810.67	317	983 035.86	4 443 520.41
198	984 454.31	4 443 410.61	258	981 808.26	4 443 807.34	318	983 036.12	4 443 519.98
199	984 352	4 443 272.81	259	982 125.76	4 443 732.25	319	983 036.53	4 443 522.18
200	984 351.87	4 443 266.85	260	982 609.38	4 443 606.2	320	983 394.04	4 443 444.67
201	984 357.89	4 443 266.68	261	982 697.88	4 443 588.89	321	983 393.62	4 443 442.51
202	984 358.02	4 443 272.64	262	983 011.21	4 443 518.51	322	983 395.88	4 443 442.08
203	984 408.62	4 443 344.12	263	983 587.03	4 443 392.86	323	983 396.29	4 443 444.28
204	984 407.53	4 443 342.2	264	982 597.26	4 443 618.17	324	983 110.04	4 443 506.6
205	984 409.54	4 443 341.07	265	982 596.78	4 443 616.02	325	983 109.62	4 443 504.44
206	984 410.63	4 443 343.03	266	982 599.02	4 443 615.53	326	983 111.88	4 443 504.01
207	984 366.64	4 443 277.31	267	982 599.5	4 443 617.7	327	983 112.29	4 443 506.21
208	984 363.73	4 443 276.23	268	983 581.7	4 443 405.77	328	983 398.29	4 443 453.29
209	984 364.88	4 443 274.24	269	983 581.28	4 443 403.61	329	983 399.11	4 443 450.28
210	984 366.81	4 443 275.36	270	983 583.54	4 443 403.18	330	983 373.13	4 443 450.19
211	983 694.91	4 443 392.28	271	983 583.95	4 443 405.38	331	983 373.3	4 443 453.19
212	983 694.99	4 443 388.7	272	982 614.21	4 443 614.54	332	983 135.63	4 443 504.55
213	983 720.26	4 443 382.74	273	982 613.73	4 443 612.4	333	983 135.57	4 443 501.55
214	984 026.17	4 443 308.94	274	982 703.54	4 443 592.86	334	983 139.58	4 443 501.45
215	984 083.6	4 443 294.85	275	982 703.95	4 443 595.06	335	983 139.65	4 443 504.45
216	984 085.43	4 443 304.4	276	983 587.14	4 443 410.37	336	983 329.46	4 443 459.15
217	983 845.79	4 443 361.23	277	983 588.98	4 443 406.34	337	983 328.78	4 443 456.41
218	983 844.32	4 443 355.28	278	983 573	4 443 406.17	338	983 335.1	4 443 454.97
219	983 632.4	4 443 399.5	279	983 573.16	4 443 410.19	339	983 335.78	4 443 457.68
220	983 633.33	4 443 383.09	280	982 739.23	4 443 587.52	340	983 194.02	4 443 491.75
221	983 671.34	4 443 375.38	281	982 738.55	4 443 584.77	341	983 193.95	4 443 488.74
222	983 671.1	4 443 379.36	282	982 744.87	4 443 583.34	342	983 197.97	4 443 488.59
223	983 670.44	4 443 390.5	283	982 745.55	4 443 586.05	343	983 198.03	4 443 491.6
224	983 588.34	4 443 408.25	284	983 521.96	4 443 419.46	344	983 310.22	4 443 466.19
225	983 578.96	4 443 409.59	285	983 521.81	4 443 418.88	345	983 309.94	4 443 463.23
226	983 234.93	4 443 484.35	286	983 517.21	4 443 417.96	346	983 313.96	4 443 462.91
227	983 081.49	4 443 516.81	287	983 516.53	4 443 415.21	347	983 314.14	4 443 465.92
228	983 080.76	4 443 513.87	288	983 522.85	4 443 413.77	348	983 183.8	4 443 490.55
229	983 078.84	4 443 514.72	289	983 523.52	4 443 416.44	349	983 183.38	4 443 488.39
230	983 077.57	4 443 517.62	290	983 525.8	4 443 416.35	350	983 185.64	4 443 487.96
231	983 022.99	4 443 529.18	291	983 525.98	4 443 419.37	351	983 186.05	4 443 490.15
232	983 022.37	4 443 526.29	292	982 815.08	4 443 570.75	352	983 257.64	4 443 474.41
233	983 018.46	4 443 527.14	293	982 814.86	4 443 568.59	353	983 257.22	4 443 472.24
234	983 019.08	4 443 530	294	982 816.92	4 443 568.16	354	983 259.48	4 443 471.81
235	983 007.87	4 443 532.38	295	982 817.33	4 443 570.35	355	983 259.89	4 443 474.01
236	982 984.4	4 443 541.58	296	983 478.55	4 443 429.52	356	983 252.4	4 443 478.94
237	982 983.78	4 443 538.67	297	983 476.49	4 443 426.57	357	983 252.34	4 443 475.94
238	982 959.86	4 443 539.46						

Номер	X	Y	Номер	X	Y	Номер	X	Y
361	983 632.22	4 443 403.62	421	984 707.36	4 443 785.91	481	982 493.73	4 443 652.4
362	983 632.22	4 443 403.59	422	984 709.24	4 443 784.59	482	982 493.01	4 443 649.48
363	983 670.15	4 443 394.58	423	984 710.56	4 443 786.3	483	982 602.43	4 443 622.15
364	983 670	4 443 396.82	424	984 626.2	4 443 660.86	484	982 807.66	4 443 578.73
365	983 014.55	4 443 540.45	425	984 625.1	4 443 679.04	485	982 917.56	4 443 555.5
366	983 013.41	4 443 535.24	426	984 626.6	4 443 678.25	486	982 917.58	4 443 555.65
367	983 235.76	4 443 488.17	427	984 622.08	4 443 678.38	487	982 609.92	4 443 622.62
368	983 579.78	4 443 413.43	428	984 621.92	4 443 674.35	488	982 611.24	4 443 628.34
369	983 586.16	4 443 412.27	429	984 627.95	4 443 674.18	489	982 386.12	4 443 690.23
370	983 585.85	4 443 418.13	430	984 628.11	4 443 678.21	490	982 352.09	4 443 699.1
371	983 563.91	4 443 422.93	431	984 627.29	4 443 678.24	491	982 271.99	4 443 719.97
372	983 350.7	4 443 467.19	432	984 628.23	4 443 679.83	492	982 131.95	4 443 756.46
373	984 541.49	4 443 562.38	433	984 694.29	4 443 769.64	493	982 101.45	4 443 763.67
374	984 509.2	4 443 512.4	434	984 694.23	4 443 766.64	494	981 928.08	4 443 804.66
375	984 501.89	4 443 517.34	435	984 698.24	4 443 766.54	495	981 926.97	4 443 799.85
376	984 501.84	4 443 517.29	436	984 698.3	4 443 769.55	496	981 985.24	4 443 779.79
377	984 504.75	4 443 510.12	437	984 658.91	4 443 723.72	497	981 984.62	4 443 776.82
378	984 511	4 443 488.97	438	984 658.85	4 443 720.72	498	981 988.53	4 443 775.97
379	984 555.66	4 443 553.29	439	984 662.86	4 443 720.62	499	981 989.15	4 443 778.94
380	984 539.21	4 443 546.13	440	984 662.92	4 443 723.63	500	982 325.31	4 443 694.64
381	984 538.11	4 443 544.32	441	984 667.3	4 443 734.19	501	982 324.58	4 443 691.68
382	984 540.14	4 443 543.25	442	984 665.99	4 443 732.53	502	982 328.49	4 443 690.78
383	984 541.24	4 443 545.1	443	984 667.87	4 443 731.21	503	982 329.22	4 443 693.69
384	984 520.48	4 443 529.76	444	984 669.19	4 443 732.92	504	982 047.21	4 443 765.26
385	984 520.42	4 443 526.75	445	981 810.7	4 443 826.91	505	982 046.59	4 443 762.3
386	984 524.43	4 443 526.66	446	981 809.8	4 443 823.04	506	982 050.41	4 443 761.39
387	984 524.5	4 443 529.66	447	981 799.52	4 443 825.44	507	982 051.14	4 443 764.36
388	984 771.03	4 443 886.77	448	981 799.22	4 443 824.63	508	982 268.49	4 443 769.89
389	984 620.11	4 443 684.07	449	981 798.22	4 443 821.94	509	982 265.81	4 443 767.14
390	984 542.08	4 443 563.3	450	981 813.99	4 443 818.14	510	982 288.28	4 443 766.46
391	984 556.32	4 443 554.16	451	981 814.72	4 443 821.1	511	982 272.2	4 443 765.44
392	984 636.06	4 443 668.84	452	981 818.53	4 443 820.13	512	982 272.93	4 443 768.35
393	984 772.75	4 443 846.18	453	981 817.91	4 443 817.23	513	982 269.13	4 443 769.37
394	984 771.22	4 443 881.9	454	981 867.81	4 443 805.18	514	982 092.51	4 443 755.57
395	984 771.16	4 443 883.35	455	981 868.43	4 443 808.1	515	982 092.38	4 443 749.55
396	984 765.15	4 443 861.52	456	981 872.35	4 443 807.25	516	982 098.3	4 443 749.38
397	984 765.09	4 443 858.52	457	981 871.63	4 443 804.26	517	982 098.54	4 443 755.39
398	984 768.99	4 443 858.36	458	981 893.99	4 443 798.84	518	982 211.27	4 443 724.39
399	984 769.17	4 443 861.37	459	981 925.88	4 443 790.92	519	982 210.53	4 443 721.48
400	984 554.8	4 443 578.98	460	981 926.61	4 443 793.83	520	982 214.34	4 443 720.46
401	984 554.74	4 443 576.03	461	981 930.53	4 443 792.93	521	982 215.07	4 443 723.38
402	984 556.75	4 443 575.88	462	981 929.8	4 443 789.96	522	982 153.75	4 443 738.56
403	984 558.81	4 443 578.89	463	982 117.51	4 443 743.14	523	982 153.69	4 443 735.65
404	984 749.7	4 443 841.21	464	982 117.75	4 443 744.22	524	982 157.7	4 443 735.45
405	984 748.39	4 443 839.54	465	982 119.99	4 443 743.76	525	982 157.77	4 443 738.41
406	984 750.27	4 443 838.23	466	982 119.73	4 443 742.59	526	982 193.19	4 443 726.67
407	984 751.59	4 443 839.94	467	982 334.74	4 443 688.96	527	982 192.71	4 443 724.52
408	984 562.79	4 443 613.55	468	982 335.14	4 443 690.77	528	982 194.95	4 443 724.03
409	984 561.69	4 443 611.73	469	982 337.38	4 443 690.31	529	982 195.43	4 443 726.21
410	984 583.72	4 443 610.66	470	982 336.96	4 443 688.41	530	981 734.23	4 443 831.2
411	984 584.82	4 443 612.51	471	982 378.98	4 443 678.15	531	981 731.96	4 443 825.2
412	984 729.78	4 443 815.55	472	982 378.81	4 443 681.06	532	981 771.8	4 443 815.46
413	984 729.6	4 443 812.55	473	982 382.73	4 443 680.1	533	981 774.16	4 443 821.87
414	984 733.62	4 443 812.45	474	982 382	4 443 677.16	534	981 737.37	4 443 839.89
415	984 733.68	4 443 815.46	475	982 434.81	4 443 663.97	536	981 737.09	4 443 839.12
416	984 589.34	4 443 628.59	476	982 435.54	4 443 666.88	536	981 736.25	4 443 836.86
417	984 589.16	4 443 625.58	477	982 439.35	4 443 665.97	537	981 759.06	4 443 831.61

Номер	X	Y	Номер	X	Y	Номер	X	Y
541	981 776.18	4 443 827.24	601	981 332.69	4 443 924.36	661	984 832.67	4 443 945.25
542	981 777.1	4 443 829.76	602	981 333.17	4 443 926.56	662	984 833.99	4 443 946.96
543	981 777.4	4 443 830.58	603	981 705.19	4 443 847.43	663	985 010.87	4 444 403.81
544	981 620.04	4 443 860.84	604	981 704.45	4 443 844.52	664	985 009.76	4 444 401.9
545	981 380.28	4 443 918.24	605	981 710.84	4 443 842.97	665	985 011.82	4 444 400.87
546	980 923.11	4 444 027.81	606	981 711.58	4 443 845.01	666	985 012.88	4 444 402.77
547	980 919.19	4 444 023.25	607	981 711.87	4 443 845.82	667	984 835.9	4 443 953.34
548	980 914.56	4 444 027.32	608	981 658.43	4 443 858.25	668	984 835.84	4 443 950.34
549	980 917.95	4 444 031.08	609	981 657.9	4 443 855.75	669	984 839.85	4 443 950.24
550	980 891.37	4 444 065.57	610	981 700.55	4 443 845.46	670	984 839.91	4 443 953.24
551	980 890.43	4 444 065.02	611	981 701.27	4 443 848.34	671	985 004.75	4 444 401.84
552	980 904.66	4 444 035.11	612	981 324.53	4 443 935.91	672	985 004.68	4 444 398.83
553	980 908.26	4 444 027.53	613	981 324.35	4 443 935.7	673	985 008.7	4 444 398.74
554	980 911.08	4 444 021.61	614	981 820.9	4 443 864.64	674	985 008.76	4 444 401.74
555	980 918.24	4 444 017.75	615	981 650.9	4 443 857.48	675	984 873.57	4 444 001.86
556	980 932.53	4 444 014.38	616	981 853.88	4 443 856.66	676	984 872.3	4 444 000.25
557	980 962.94	4 444 007.18	617	981 854.52	4 443 859.16	677	984 870.82	4 444 000.31
558	981 062.5	4 443 983.64	618	984 800.55	4 443 926.42	678	984 870.68	4 443 994.79
559	981 706.56	4 443 831.34	619	984 781.46	4 443 900.79	679	984 876.7	4 443 994.61
560	981 708.68	4 443 837.18	620	984 781.46	4 443 900.79	680	984 876.84	4 444 000.03
561	981 685.12	4 443 842.64	621	984 781.48	4 443 900.82	681	984 875.09	4 444 000.12
562	981 685.66	4 443 845.05	622	984 781.67	4 443 895.43	682	984 875.46	4 444 000.59
563	980 983.32	4 444 012.94	623	984 782.07	4 443 883.79	683	984 982.47	4 444 354.14
564	980 962.53	4 444 010.84	624	984 783.23	4 443 859.72	684	984 981.69	4 444 352.09
565	980 964.58	4 444 010.08	625	984 802.23	4 443 884.44	685	984 983.88	4 444 351.39
566	980 965.38	4 444 012.23	626	984 796.26	4 443 902.11	686	984 984.62	4 444 353.43
567	981 624.98	4 443 858.81	627	984 796.09	4 443 899.15	687	984 878.94	4 444 050.19
568	981 624.5	4 443 856.87	628	984 800.1	4 443 899	688	984 878.78	4 444 046.21
569	981 626.74	4 443 856.17	629	984 800.16	4 443 902.01	689	984 884.8	4 444 045.99
570	981 627.22	4 443 858.35	630	984 790.81	4 443 894.59	690	984 884.85	4 444 050.02
571	981 036.98	4 443 995.66	631	984 789.5	4 443 892.92	691	984 975.32	4 444 352.81
572	981 036.48	4 443 993.52	632	984 791.38	4 443 891.61	692	984 975.16	4 444 348.78
573	981 038.72	4 443 993.02	633	984 792.7	4 443 893.32	693	984 981.19	4 444 348.61
574	981 039.2	4 443 995.2	634	985 024.39	4 444 456.02	694	984 981.34	4 444 352.63
575	981 551.5	4 443 875.93	635	985 018.74	4 444 447.03	695	984 888.91	4 444 074.31
576	981 551.02	4 443 873.79	636	985 002.9	4 444 419.78	696	984 888.54	4 444 072.15
577	981 553.26	4 443 873.29	637	984 982.37	4 444 383.81	697	984 890.82	4 444 071.9
578	981 553.74	4 443 875.47	638	984 971.39	4 444 362.29	698	984 891.15	4 444 074.03
579	981 110.36	4 443 978.45	639	984 961.37	4 444 342.66	699	984 959.28	4 444 310.54
580	981 109.88	4 443 976.31	640	984 911.18	4 444 225.63	700	984 959.21	4 444 307.53
581	981 112.12	4 443 975.81	641	984 890.33	4 444 150.05	701	984 963.23	4 444 307.43
582	981 112.6	4 443 977.99	642	984 858.2	4 444 003.87	702	984 963.29	4 444 310.44
583	981 478.18	4 443 892.87	643	984 806.2	4 443 934.03	703	984 889.51	4 444 100.1
584	981 477.7	4 443 890.73	644	984 807.95	4 443 891.89	704	984 889.33	4 444 097.09
585	981 479.94	4 443 890.23	645	984 885.65	4 443 992.39	705	984 893.35	4 444 096.95
586	981 480.42	4 443 892.41	646	984 913.19	4 444 145.82	706	984 893.41	4 444 099.95
587	981 183.68	4 443 961.53	647	984 938.29	4 444 221.13	707	984 953.85	4 444 287.4
588	981 183.2	4 443 959.38	648	984 890.48	4 444 345.16	708	984 953.07	4 444 285.34
589	981 185.44	4 443 958.89	649	985 048.49	4 444 448.03	709	984 955.26	4 444 284.65
590	981 185.92	4 443 961.06	650	985 032.71	4 444 451.43	710	984 956	4 444 286.69
591	981 404.87	4 443 910.17	651	985 032.65	4 444 448.42	711	984 905.09	4 444 149.49
592	981 404.39	4 443 908.02	652	985 036.55	4 444 448.32	712	984 903.89	4 444 143.13
593	981 406.63	4 443 907.53	653	985 036.58	4 444 448.93	713	984 906.66	4 444 142.56
594	981 407.11	4 443 909.7	654	985 038.55	4 444 447.94	714	984 907.84	4 444 148.96
595	981 257.35	4 443 944.49	655	985 039.61	4 444 449.84	715	984 941.65	4 444 288.64
596	981 256.87	4 443 942.35	656	985 037.6	4 444 450.89	716	984 941.59	4 444 285.82
597	981 259.11	4 443 941.85	657	985 036.6	4 444 449.16	717	984 945.6	4 444 265.73
			658	985 036.72	4 444 451.33			

Номер	X	Y	Номер	X	Y	Номер	X	Y
721	984 902.04	4 444 145.53	781	980 837.11	4 444 303.5	841	985 454.52	4 445 635.49
722	984 903.62	4 444 151.36	782	980 838.91	4 444 296.08	842	985 068.81	4 444 515.7
723	984 922.7	4 444 227.7	783	980 838.78	4 444 296.3	843	985 068.75	4 444 512.74
724	984 922.54	4 444 223.67	784	980 828.19	4 444 347.85	844	985 072.76	4 444 512.59
725	984 928.56	4 444 223.5	785	980 826.76	4 444 347.86	845	985 072.82	4 444 515.6
726	984 928.72	4 444 227.52	786	980 826.83	4 444 350.88	846	985 447.4	4 445 633.23
727	984 911.39	4 444 188.83	787	980 827.51	4 444 350.87	847	985 447.16	4 445 627.22
728	984 911.33	4 444 185.82	788	980 816.02	4 444 402.13	848	985 453.18	4 445 626.94
729	984 915.23	4 444 185.67	789	980 814.09	4 444 402.2	849	985 453.42	4 445 632.95
730	984 915.41	4 444 188.68	790	980 814.16	4 444 405.21	850	985 087.17	4 444 552.31
731	984 925.46	4 444 221.85	791	980 815.34	4 444 405.16	851	985 066.82	4 444 546.29
732	984 925.09	4 444 219.69	792	980 803.91	4 444 456.36	852	985 091.56	4 444 546.04
733	984 927.37	4 444 219.44	793	980 777.07	4 444 595.02	853	985 091.24	4 444 545.49
734	984 927.7	4 444 221.57	794	980 777.14	4 444 567.76	854	985 093.31	4 444 544.46
735	980 967.13	4 444 025.2	795	980 781.04	4 444 567.79	855	985 094.37	4 444 546.36
736	980 966.27	4 444 021.51	796	980 781.09	4 444 564.84	856	985 092.93	4 444 547.11
737	981 066.06	4 443 997.6	797	980 777.08	4 444 564.83	857	985 093.21	4 444 552.03
738	981 067.04	4 444 001.79	798	980 777.08	4 444 557.85	858	985 429.82	4 445 574.8
739	980 878.4	4 444 128.2	799	980 801.09	4 444 456.47	859	985 429.85	4 445 571.85
740	980 891.68	4 444 071.55	800	980 801.15	4 444 459.43	860	985 433.87	4 445 571.7
741	980 921.99	4 444 032.12	801	980 803.23	4 444 459.38	861	985 433.93	4 445 574.71
742	980 959.31	4 444 023.18	802	980 796.92	4 444 487.85	862	985 108.01	4 444 609.09
743	980 920.58	4 444 044.16	803	980 804.66	4 444 489.36	863	985 107.95	4 444 606.08
744	980 897.98	4 444 070.71	804	980 787.51	4 444 566.98	864	985 111.96	4 444 605.98
745	980 889.5	4 444 067	805	980 783.59	4 444 566.15	865	985 112.03	4 444 608.99
746	980 890.03	4 444 067.31	806	980 788.37	4 444 513.54	866	985 428.87	4 445 565.41
747	980 888.26	4 444 069.61	807	980 788.31	4 444 510.59	867	985 428.24	4 445 563.32
748	980 888.26	4 444 069.61	808	980 792.32	4 444 510.43	868	985 430.45	4 445 562.72
749	980 808.66	4 444 407.49	809	980 792.39	4 444 513.44	869	985 431.14	4 445 564.78
750	980 783.71	4 444 512.85	810	985 049.72	4 444 497.09	870	985 116.18	4 444 620.03
751	980 782.69	4 444 517.06	811	985 043.84	4 444 487.61	871	985 115.41	4 444 617.98
752	980 781.01	4 444 516.74	812	985 041.67	4 444 484.03	872	985 117.62	4 444 617.3
753	980 780.6	4 444 518.9	813	985 030.37	4 444 465.61	873	985 118.34	4 444 619.36
754	980 782.15	4 444 519.18	814	985 053.92	4 444 457.82	874	985 410.96	4 445 517.97
755	980 777.13	4 444 540.39	815	985 072.19	4 444 490.11	875	985 410.89	4 445 514.96
756	980 777.19	4 444 515.19	816	985 047.61	4 444 482.52	876	985 414.91	4 445 514.81
757	980 865.58	4 444 128.82	817	985 047.37	4 444 476.56	877	985 414.97	4 445 517.81
758	980 799.76	4 444 442.64	818	985 053.39	4 444 476.22	878	985 126.42	4 444 664.38
759	980 797.55	4 444 442.23	819	985 053.63	4 444 482.24	879	985 126.35	4 444 661.37
760	980 797.96	4 444 440.07	820	985 426.37	4 445 696.3	880	985 130.37	4 444 661.22
761	980 800.21	4 444 440.5	821	985 423	4 445 686.33	881	985 130.43	4 444 664.22
762	980 868.14	4 444 137.11	822	985 426.76	4 445 685.06	882	985 404.71	4 445 492.62
763	980 865.93	4 444 136.7	823	985 425.8	4 445 682.21	883	985 404.08	4 445 490.53
764	980 866.34	4 444 134.55	824	985 422	4 445 683.38	884	985 406.29	4 445 489.93
765	980 868.59	4 444 134.97	825	985 419.75	4 445 676.81	885	985 406.98	4 445 491.99
766	980 817.05	4 444 386.33	826	985 438.16	4 445 640.58	886	985 139.96	4 444 692.65
767	980 814.84	4 444 365.91	827	985 078.01	4 444 552.26	887	985 139.41	4 444 690.53
768	980 815.25	4 444 363.78	828	985 066.05	4 444 531.19	888	985 141.62	4 444 689.87
769	980 817.5	4 444 364.19	829	985 061.62	4 444 519.12	889	985 142.34	4 444 691.92
770	980 850.94	4 444 213.52	830	985 055.13	4 444 507.11	890	985 392.01	4 445 461.06
771	980 848.73	4 444 213.1	831	985 067.44	4 444 503.16	891	985 391.94	4 445 458.06
772	980 849.14	4 444 210.95	832	985 068.16	4 444 504.48	892	985 395.96	4 445 457.96
773	980 851.39	4 444 211.38	833	985 070.11	4 444 503.47	893	985 396.02	4 445 460.96
774	980 834	4 444 289.92	834	985 069.57	4 444 502.46	894	985 145.48	4 444 721.23
775	980 831.78	4 444 289.51	835	985 077.66	4 444 499.93	895	985 145.3	4 444 718.22
776	980 832.19	4 444 287.36	836	985 102.33	4 444 545.95	896	985 149.32	4 444 718.12
777	980 834.45	4 444 287.78	837	985 462.98	4 445 634.5	897	985 149.49	4 444 721.14

Номер	X	Y	Номер	X	Y	Номер	X	Y
901	985 382.95	4 445 419.16	951	985 301.27	4 445 176.58	1 021	985 260.57	4 445 961.96
902	985 164.31	4 444 765.3	962	985 236.41	4 444 983.59	1 022	985 258.55	4 445 960.02
903	985 163.67	4 444 763.18	963	985 235.74	4 444 981.47	1 023	985 263.07	4 445 955.38
904	985 165.88	4 444 762.52	964	985 237.95	4 444 980.81	1 024	985 265.13	4 445 957.32
905	985 166.6	4 444 764.58	965	985 238.67	4 444 982.86	1 025	985 366.99	4 445 794.66
906	985 373.06	4 445 404.17	966	985 284.41	4 445 129.08	1 026	985 366.93	4 445 791.65
907	985 373	4 445 401.21	967	985 283.74	4 445 126.96	1 027	985 370.94	4 445 791.55
908	985 377.01	4 445 401.07	968	985 285.95	4 445 126.3	1 028	985 371	4 445 794.56
909	985 377.07	4 445 404.07	969	985 286.67	4 445 128.35	1 029	985 250.43	4 445 952.74
910	985 164.42	4 444 778.14	970	985 240.2	4 445 005.64	1 030	985 256.45	4 445 952.41
911	985 164.35	4 444 775.13	971	985 240.13	4 445 002.64	1 031	985 256.58	4 445 958.53
912	985 168.25	4 444 775.03	972	985 244.15	4 445 002.49	1 032	985 250.67	4 445 958.71
913	985 168.43	4 444 777.98	973	985 244.21	4 445 005.5	1 033	985 343.7	4 445 856.3
914	985 354.1	4 445 347.32	974	985 278.3	4 445 119.77	1 034	985 341.25	4 445 854.95
915	985 354.04	4 445 344.32	975	985 278.12	4 445 116.77	1 035	985 343.87	4 445 850.29
916	985 358.05	4 445 344.22	976	985 282.15	4 445 116.67	1 036	985 338.38	4 445 850.55
917	985 358.06	4 445 344.52	977	985 282.32	4 445 119.67	1 037	985 338.03	4 445 844.6
918	985 358.23	4 445 344.46	978	985 280.5	4 445 056.37	1 038	985 344.05	4 445 844.26
919	985 359.04	4 445 346.48	979	985 259.83	4 445 054.25	1 039	985 344.26	4 445 849.59
920	985 358.11	4 445 346.78	980	985 262.04	4 445 053.59	1 040	985 344.43	4 445 849.31
921	985 358.12	4 445 347.17	981	985 262.76	4 445 055.64	1 041	985 346.91	4 445 850.64
922	985 183.35	4 444 834.99	982	985 259.14	4 445 062.49	1 042	985 281.46	4 445 921.08
923	985 183.29	4 444 831.98	983	985 259.08	4 445 059.49	1 043	985 281.38	4 445 918.14
924	985 187.31	4 444 831.88	984	985 263.09	4 445 059.39	1 044	985 285.4	4 445 917.98
925	985 187.38	4 444 834.89	985	985 263.15	4 445 062.4	1 045	985 285.47	4 445 920.99
926	985 335.16	4 445 290.43	986	985 415.91	4 445 684.34	1 046	985 310.65	4 445 885
927	985 335.09	4 445 287.42	987	985 416.27	4 445 685.39	1 047	985 310.59	4 445 881.99
928	985 339.1	4 445 287.32	988	985 422.14	4 445 702.86	1 048	985 314.6	4 445 881.84
929	985 339.17	4 445 290.33	989	985 348.93	4 445 852.65	1 049	985 314.66	4 445 884.85
930	985 188.21	4 444 838.18	990	985 261.64	4 445 962.31	1 050	985 302.69	4 445 907.48
931	985 187.54	4 444 836.06	991	985 203.97	4 446 016.69	1 051	985 301	4 445 906.11
932	985 189.75	4 444 835.4	992	985 176.27	4 446 025.62	1 052	985 302.48	4 445 904.38
933	985 190.47	4 444 837.46	993	985 157.37	4 446 031.72	1 053	985 304.21	4 445 905.68
934	985 332.72	4 445 274.4	994	985 250.43	4 445 952.74			
935	985 332.12	4 445 272.29	995	985 278.7	4 445 917.27			
936	985 334.35	4 445 271.73	996	985 333.58	4 445 846.25			
937	985 334.99	4 445 273.8	997	985 174.75	4 446 024.82			
938	985 202.3	4 444 891.9	998	985 174.68	4 446 021.82			
939	985 202.24	4 444 888.88	999	985 178.59	4 446 021.71			
940	985 206.25	4 444 888.74	1 000	985 178.76	4 446 024.72			
941	985 206.32	4 444 891.74	1 001	985 417.58	4 445 709.81			
942	985 316.2	4 445 233.58	1 002	985 415.67	4 445 708.76			
943	985 316.13	4 445 230.57	1 003	985 416.82	4 445 706.79			
944	985 320.15	4 445 230.42	1 004	985 418.76	4 445 707.78			
945	985 320.21	4 445 233.42	1 005	985 201.06	4 446 011.66			
946	985 212.38	4 444 910.79	1 006	985 199.71	4 446 009.97			
947	985 211.71	4 444 908.67	1 007	985 201.52	4 446 008.59			
948	985 213.92	4 444 908.01	1 008	985 202.93	4 446 010.24			
949	985 214.64	4 444 910.07	1 009	985 394.25	4 445 740.41			
950	985 308.45	4 445 201.61	1 010	985 394.18	4 445 737.41			
951	985 307.85	4 445 199.51	1 011	985 398.2	4 445 737.26			
952	985 310.08	4 445 198.04	1 012	985 398.26	4 445 740.28			
953	985 310.72	4 445 201.02	1 013	985 213.61	4 445 930.97			
954	985 221.25	4 444 948.74	1 014	985 213.44	4 445 987.96			
955	985 221.18	4 444 945.74	1 015	985 217.45	4 445 987.86			
956	985 225.19	4 444 945.64	1 016	985 217.51	4 445 990.87			
957	985 225.26	4 444 946.64	1 017	985 380.89	4 445 781.99			
			1 018	985 378.98	4 445 780.93			

Номер	X	Y	Номер	X	Y	Номер	X	Y
1	957 275 67	4 412 524 66	61	957 329 89	4 413 027 24	121	956 285 96	4 415 450 02
2	957 275 78	4 412 520 95	62	957 326 53	4 413 077 5	122	956 270 4	4 415 446 58
3	957 287 25	4 412 523 6	63	957 333 18	4 413 041 66	123	956 274 84	4 415 448 67
4	957 294 82	4 412 529 6	64	957 334 25	4 413 046 37	124	956 286 34	4 415 452 2
5	957 275 04	4 412 549 97	65	957 331 86	4 413 066 84	125	956 303 07	4 415 382 49
6	957 300 94	4 412 556	66	957 327 84	4 413 075 56	126	956 285 79	4 415 460 14
7	957 301 38	4 412 556 62	67	957 326 53	4 413 077 5	127	956 277 34	4 415 460 49
8	957 315 52	4 412 561 94	68	957 321 59	4 413 083 11	128	956 265 5	4 415 498 10
9	957 319 61	4 412 562 9	69	957 260 18	4 413 119 16	129	956 230 32	4 415 455 24
10	957 321 39	4 412 573 58	70	957 260 16	4 413 117 12	130	956 211 84	4 415 448 08
11	957 315 72	4 412 572 26	71	956 627 12	4 413 997 79	131	956 212 21	4 415 448 74
12	957 311 92	4 412 571 37	72	956 630 85	4 413 997 98	132	956 227 51	4 415 448 86
13	957 320 06	4 412 574 24	73	956 618 13	4 414 025 36	133	956 229 87	4 415 452 92
14	957 321 06	4 412 574 89	74	956 617 81	4 414 033 64	134	956 253 97	4 415 461 83
15	957 316 74	4 412 579 46	75	956 620 48	4 414 046 69	135	956 247 57	4 415 461 93
16	957 314 07	4 412 577 96	76	956 619 35	4 414 054 92	136	956 235 49	4 415 457 25
17	957 304 28	4 412 575 78	77	956 615 54	4 414 062 32	137	956 243 05	4 415 458 46
18	957 306 7	4 412 580 11	78	956 610 65	4 414 066 28	138	956 256 33	4 415 453 36
19	957 298 56	4 412 588 71	79	956 602 58	4 414 074 18	139	956 241 61	4 415 585 87
20	957 295 41	4 412 588 38	80	956 592 43	4 414 080 68	140	956 234 28	4 415 583 75
21	957 295 97	4 412 561 51	81	956 520 25	4 414 236 08	141	956 234 89	4 415 581 6
22	957 296 99	4 412 557 19	82	956 508 92	4 414 264 8	142	956 236 66	4 415 582 18
23	957 294 1	4 412 556 52	83	956 515 06	4 414 556 13	143	956 237 02	4 415 581 17
24	957 274 99	4 412 551 6	84	956 469 93	4 414 756 79	144	956 236 03	4 415 580 85
25	957 308 83	4 412 602 79	85	956 352 5	4 415 278 72	145	956 231 16	4 415 579 34
26	957 308 84	4 412 602 79	86	956 328 6	4 415 384 92	146	956 240 87	4 415 547 96
27	957 325 45	4 412 597 96	87	956 325 76	4 415 397 51	147	956 250 06	4 415 550 6
28	957 331 19	4 412 632 48	88	956 319 69	4 415 419 27	148	956 246 14	4 415 583 96
29	957 314 68	4 412 637 39	89	956 303 2	4 415 481 53	149	956 245 29	4 415 585 28
30	957 313 62	4 412 625 09	90	956 279 39	4 415 559 88	150	956 241 79	4 415 583 86
31	957 298 08	4 412 625 19	91	956 286 72	4 415 562 14	151	956 243 04	4 415 580 93
32	957 295 05	4 412 622 21	92	956 276 35	4 415 565 17	152	956 246 44	4 415 582 56
33	957 295 24	4 412 609 77	93	956 274 56	4 415 594 73	153	956 134 31	4 415 739 49
34	957 302 13	4 412 610 96	94	956 280 1	4 415 576 84	154	956 134 29	4 415 739 26
35	957 308 4	4 412 604 7	95	956 271 31	4 415 574 11	155	956 149 36	4 415 730 16
36	957 318 71	4 412 614 44	96	956 314 59	4 415 434 05	156	956 145 06	4 415 722 89
37	957 318 31	4 412 612 27	97	956 350 19	4 415 275 77	157	956 156 37	4 415 718 29
38	957 320 58	4 412 611 66	98	956 512 53	4 414 954 03	158	956 156 8	4 415 717 11
39	957 320 97	4 412 614 02	99	956 504 46	4 414 261 87	159	956 158 33	4 415 716 32
40	957 317 75	4 412 655 63	100	956 518 11	4 414 232 5	160	956 159 23	4 415 715 85
41	957 316 36	4 412 659 24	101	956 590 45	4 414 076 75	161	956 159 48	4 415 715 73
42	957 308 91	4 412 660 82	102	956 597 02	4 414 070 86	162	956 158 98	4 415 714 72
43	957 311 43	4 412 675 54	103	956 602 15	4 414 069 03	163	956 176	4 415 704 72
44	957 318 19	4 412 684 15	104	956 610 63	4 414 063 04	164	956 186 61	4 415 694 26
45	957 330 09	4 412 925 52	105	956 614 52	4 414 057 13	165	956 197 63	4 415 687 66
46	957 311 64	4 413 014 65	106	956 617 2	4 414 051 35	166	956 227 87	4 415 589 97
47	957 310 46	4 413 009 45	107	956 618 05	4 414 044 41	167	956 230 34	4 415 590 69
48	957 327 96	4 412 924 57	108	956 615 56	4 414 032 27	168	956 231 99	4 415 591 17
49	957 320 62	4 412 775 76	109	956 615 83	4 414 022 1	169	956 233 92	4 415 594 77
50	957 316 09	4 412 683 71	110	956 590 25	4 414 064 59	170	956 241 35	4 415 596 91
51	957 309 33	4 412 675 3	111	956 606 25	4 414 030 13	171	956 232 4	4 415 630 51
52	957 306 8	4 412 660 01	112	956 608 68	4 414 040 84	172	956 214 11	4 415 691 46
53	957 309 3	4 412 657 05	113	956 607 86	4 414 046 11	173	956 189 71	4 415 702 42
54	957 330 92	4 413 028 53	114	956 604 62	4 414 056 48	174	956 192 5	4 415 710 2
55	957 307 94	4 413 055 44	115	956 599 73	4 414 059 93	175	956 206 94	4 415 691 28
56	957 312 65	4 413 028 05	116	956 249 62	4 415 499 86	176	956 201 46	4 415 686 56
57	957 319 36	4 413 022 15	117	956 280 62	4 415 461 32	177	956 203 44	4 415 684 29

Номер	X	Y	Номер	X	Y	Номер	X	Y
181	956 222 8	4 415 626 89	241	956 342 25	4 417 223 98	301	956 074 03	4 418 753 21
182	956 226 81	4 415 626 9	242	956 316 17	4 417 509 77	302	954 985 28	4 419 422 88
183	956 135 46	4 415 789 18	243	956 322 36	4 417 509 93	303	954 985 28	4 419 511 36
184	956 135 34	4 415 766 06	244	956 342 71	4 417 466 59	304	954 983 65	4 419 499 86
185	956 162 92	4 415 749 90	245	956 357 79	4 417 473 82	305	954 983 65	4 419 499 78
186	956 168 04	4 415 758 58	246	956 277 05	4 417 541 52	306	954 983 65	4 419 499 86
187	956 236 43	4 415 718 29	247	956 258 19	4 417 716 11	307	954 983 33	4 419 439 11
188	956 274 28	4 415 595 71	248	956 244 53	4 417 712 65	308	954 983 67	4 419 437 9
189	956 278 2	4 415 596 18	249	956 234 62	4 417 750 04	309	954 901 75	4 420 278 19
190	956 238 92	4 415 719 55	250	956 174 63	4 417 976 78	310	954 905 69	4 420 231 41
191	956 167 89	4 415 781 14	251	956 153 37	4 418 079 25	311	954 908 85	4 420 219 75
192	956 162 97	4 415 753 28	252	956 149 06	4 418 101 12	312	954 903 9	4 420 275 85
193	956 457 61	4 417 983 54	253	956 149 82	4 418 129 01	313	954 889 41	4 420 416 62
194	956 456 87	4 417 982 1	254	956 141 29	4 418 175 3	314	954 891 83	4 420 389 98
195	956 444 16	4 417 140 06	255	956 137 28	4 418 182 54	315	954 893 27	4 420 372 85
196	956 442 45	4 417 137 99	256	956 138 27	4 418 173 58	316	954 895 07	4 420 376 09
197	956 404 16	4 417 291 87	257	956 130 3	4 418 173 82	317	954 892 86	4 420 403 35
198	956 402 32	4 417 291 26	258	956 140 47	4 418 189 96	318	954 770 91	4 420 962 77
199	956 383 57	4 417 192 11	259	956 141 51	4 418 181 81	319	954 872 71	4 420 806 51
200	956 385 54	4 417 188 65	260	956 140 22	4 418 156 24	320	954 886 93	4 420 444 83
201	956 389 4	4 417 184 7	261	956 140 19	4 418 156 24	321	954 888 84	4 420 446 71
202	956 394 1	4 417 181 6	262	956 142 42	4 418 138 1	322	954 874 44	4 420 610 07
203	956 399 18	4 417 180 17	263	956 148 33	4 418 129 71	323	954 802 12	4 420 863 11
204	956 404 69	4 417 179 8	264	956 148 56	4 418 117 71	324	954 774 02	4 420 961 46
205	956 409 82	4 417 180 33	265	956 146 61	4 418 100 69	325	954 753 6	4 421 022 82
206	956 429 65	4 417 183 96	266	956 166 32	4 417 998 45	326	954 789 65	4 420 967 21
207	956 431 82	4 417 186 86	267	956 243 93	4 417 688 67	327	954 770 25	4 420 974 85
208	956 428 19	4 417 200 34	268	956 257 45	4 417 692 01	328	954 796 32	4 421 021 73
209	956 441 05	4 417 203 77	269	956 264 69	4 417 662 7	329	954 856 81	4 422 162 3
210	956 438 16	4 417 214 63	270	956 264 45	4 417 622 34	330	954 858 44	4 422 113 91
211	956 422 72	4 417 208 85	271	956 271	4 417 815 75	331	954 822 98	4 421 968 14
212	956 395 32	4 417 202 82	272	956 315 56	4 417 523 06	332	954 792 96	4 421 699 12
213	956 394 6	4 417 202 59	273	956 309 38	4 417 523 96	333	954 802 37	4 421 510 17
214	956 381 73	4 417 199 05	274	956 292 72	4 417 526 35	334	954 802 93	4 421 509 78
215	956 383 2	4 417 193 49	275	956 253 91	4 417 607 39	335	954 794 61	4 421 701 82
216	956 396 89	4 417 198 78	276	956 240 25	4 417 600 7	336	954 840 05	4 422 115 14
217	956 422 33	4 417 210 31	277	956 231	4 417 632 11	337	954 844 32	4 422 113 57
218	956 429 36	4 417 213 09	278	956 226 65	4 417 646 63	338	954 862 53	4 422 160 12
219	956 427 98	4 417 214 66	279	956 217 92	4 417 682 23	339	954 951 8	4 422 526 96
220	956 421 81	4 417 212 28	280	956 224 43	4 417 683 84	340	954 894 91	4 422 128 98
221	956 350 9	4 417 249 64	281	956 218 89	4 417 706 17	341	954 814 17	4 422 124 67
222	956 356 19	4 417 234 07	282	956 208 86	4 417 703 07	342	954 814 74	4 422 128 36
223	956 359 72	4 417 216 79	283	956 214 82	4 417 650 98	343	954 814 86	4 422 128 67
224	956 365 64	4 417 214 85	284	956 222 14	4 417 622 06	344	954 812 01	4 422 129 9
225	956 361 42	4 417 234 96	285	956 333 94	4 417 386 6	345	954 815 16	4 422 138 61
226	956 361 3	4 417 236 33	286	956 328 89	4 417 400 34	346	954 816 78	4 422 133 77
227	956 360 13	4 417 239 02	287	956 305 49	4 417 448 75	347	954 859 38	4 422 247 62
228	956 357 6	4 417 247	288	956 325 32	4 417 458 27	348	954 957 15	4 422 518 39
229	956 333 02	4 417 256 69	289	956 299 56	4 417 512 06	349	954 956 56	4 422 517 36
230	956 332 62	4 417 241 33	290	956 059 12	4 418 812 95	350	954 939 37	4 422 475 15
231	956 345 62	4 417 243 51	291	956 059 61	4 418 807 21	351	954 939 08	4 422 474 23
232	956 345 96	4 417 242 49	292	956 059 96	4 418 757 98	352	954 939 96	4 422 473 92
233	956 337 98	4 417 240 57	293	956 060 77	4 418 634 07	353	954 940 27	4 422 474 84
234	956 345 5	4 417 216 63	294	956 061 41	4 418 628 72	354	954 812 3	4 422 129 43
235	956 351 29	4 417 215 5	295	956 100 58	4 418 757 97	355	954 812 1	4 422 128 46
236	956 356 06	4 417 215 87	296	956 064 83	4 418 785 76	356	954 813 1	4 422 128 31
237	956 344 54	4 417 252 14	297	956 065 07	4 418 783 72	357	954 813 3	4 422 128 28

Номер	X	Y	Номер	X	Y	Номер	X	Y
361	954 940 7	4 422 472 85	421	954 931 41	4 428 502 44	481	954 637 98	4 429 241 24
362	954 833 27	4 422 184 95	422	955 221 48	4 428 281 44	482	954 634 48	4 429 240 08
363	954 833 08	4 422 154 33	423	955 383 8	4 428 054 99	483	954 636 44	4 429 237 22
364	954 832 24	4 422 184 62	424	955 398 65	4 428 037 05	484	954 638 94	4 429 238 4
365	954 831 22	4 422 181 8	425	955 501 35	4 427 699 88	485	955 061 59	4 428 462 95
366	954 834 03	4 422 180 78	426	955 583 88	4 427 433 71	486	955 058 68	4 428 460 78
367	954 835 08	4 422 183 6	427	955 724 67	4 427 200 46	487	955 060 43	4 428 458 36
368	954 833 95	4 422 184	428	954 610 61	4 429 402 52	488	955 063 37	4 428 468 53
369	954 834 16	4 422 184 64	429	954 618 01	4 429 367 68	489	954 646 08	4 429 175 71
370	954 917 09	4 422 417 84	430	954 658 03	4 429 015 11	490	954 642 32	4 429 175 45
371	954 916 03	4 422 414 88	431	955 100 03	4 428 389 23	491	954 642 53	4 429 172 45
372	954 918 85	4 422 413 85	432	955 103 27	4 428 401 56	492	954 646 29	4 429 172 72
373	954 919 91	4 422 418 82	433	955 131 18	4 428 382 39	493	955 023 92	4 428 515 87
374	954 919 25	4 422 417 08	434	955 132 79	4 428 383 63	494	955 020 98	4 428 513 46
375	954 918 35	4 422 417 36	435	955 134 65	4 428 381 28	495	955 022 78	4 428 511 08
376	954 858 08	4 422 250 97	436	955 132 93	4 428 358 91	496	955 025 72	4 428 513 27
377	954 855 03	4 422 248 18	437	955 168 19	4 428 310 41	497	954 651 17	4 429 115 41
378	954 857 85	4 422 247 13	438	955 170 39	4 428 311 51	498	954 647 63	4 429 114 31
379	954 858 87	4 422 248 95	439	955 171 73	4 428 308 84	499	954 648 52	4 429 111 44
380	954 897 3	4 422 363 43	440	955 169 95	4 428 307 94	500	954 648 59	4 429 108 89
381	954 898 27	4 422 380 61	441	955 189 08	4 428 280 23	501	954 651 59	4 429 108 78
382	954 899 09	4 422 359 59	442	955 194 52	4 428 283 87	502	954 652 06	4 429 112 54
383	954 900 12	4 422 362 41	443	954 974 65	4 428 590 43	503	954 651 91	4 429 113 02
384	954 878 09	4 422 305 49	444	954 972 45	4 428 588 87	504	954 651 63	4 429 113 95
385	954 875 06	4 422 302 67	445	954 957 51	4 428 609 74	505	954 651 62	4 429 113 95
386	954 877 88	4 422 301 65	446	954 916 11	4 428 687 59	506	954 984 8	4 428 570 56
387	954 878 9	4 422 304 47	447	954 877 92	4 428 720 94	507	954 981 7	4 428 568 51
388	954 993 82	4 422 518 54	448	954 838 58	4 428 775 95	508	954 983 37	4 428 566 01
389	954 988 2	4 422 534 02	449	954 805 13	4 428 621 03	509	954 986 46	4 428 568 06
390	954 866 79	4 422 743 8	450	954 803 14	4 428 625 31	510	954 658 28	4 429 085 8
391	954 684 71	4 423 001 02	451	954 766 48	4 428 876 1	511	954 654 79	4 429 064 23
392	954 490 95	4 423 276	452	954 728 51	4 428 828 93	512	954 658 02	4 429 061 5
393	954 494 48	4 423 278 09	453	954 696 84	4 428 972 87	513	954 659 51	4 429 063 07
394	954 489 46	4 423 288 78	454	954 697 96	4 428 970 8	514	954 655 99	4 428 610 58
395	954 480 92	4 423 282 73	455	954 694 62	4 428 968 99	515	954 952 85	4 428 608 4
396	954 683 52	4 422 998 5	456	954 683 33	4 428 971 72	516	954 964 56	4 428 605 93
397	954 685 59	4 422 738 29	457	954 686 57	4 428 973 25	517	954 957 71	4 428 606 12
398	954 349 77	4 424 100 55	458	954 686 11	4 429 015 51	518	954 727 02	4 428 930 12
399	954 356 62	4 424 028 98	459	954 661 47	4 429 014 8	519	954 724 1	4 428 927 82
400	954 421 63	4 423 392 43	460	954 660 91	4 429 018 28	520	954 725 96	4 428 925 48
401	954 423 56	4 423 393 35	461	954 864 02	4 428 020 06	521	954 728 88	4 428 927 78
402	954 358 29	4 424 032 86	462	954 884 49	4 429 018 27	522	954 914 52	4 428 669 68
403	954 347 91	4 424 142 48	463	954 885 03	4 429 018 37	523	954 911 36	4 428 666 46
404	954 274 5	4 425 304 65	464	954 659 81	4 429 064 06	524	954 913 1	4 428 664 01
405	954 267 43	4 425 298 55	465	954 853 58	4 429 113 63	525	954 816 25	4 428 666 23
406	954 272 97	4 425 214 03	466	954 646 35	4 429 174 32	526	954 784 8	4 428 877 25
407	954 280 48	4 425 208 79	467	954 838 91	4 429 239 84	527	954 762 03	4 428 874 86
408	955 755 39	4 427 072 06	468	954 631 35	4 429 306 05	528	954 763 99	4 428 872 59
409	955 756 09	4 427 074 22	469	954 623 18	4 429 389 82	529	954 766 77	4 428 874 97
410	955 732 93	4 427 174 98	470	954 616 47	4 429 368 13	530	954 876 34	4 428 722 04
411	955 725 89	4 427 204 73	471	954 615 72	4 429 371 04	531	954 673 35	4 428 719 94
412	955 585 28	4 427 437 68	472	954 622 6	4 429 372 77	532	954 875 08	4 428 717 49
413	955 562 84	4 427 703 3	473	954 626 94	4 429 307 03	533	954 978 07	4 428 719 59
414	955 562 83	4 427 703 31	474	954 626 78	4 429 304 04	534	954 801 62	4 428 828 28
415	955 562 83	4 427 703 34	475	954 630 58	4 429 303 84	535	954 798 58	4 428 824 21
416	955 397 64	4 428 041 75	476	954 630 74	4 429 308 63	536	954 800 26	4 428 821 72
417	955 202 07	4 428 314 58	477	955 695 84	4 428 414 97	537	954 803 1	4 428 823 78

Перечень координат поворотных точек земельного участка 86:04:0000001:36247-3У2

Лист 90 из 134

Номер	X	Y	Номер	X	Y
541	954 839 83	4 428 774 34	601	956 119 87	4 436 248 97
542	954 855 07	4 428 853 14	602	956 120 24	4 436 249 08
543	954 961 1	4 428 857 44	603	956 120	4 436 250 06
544	954 895 15	4 429 024 39	604	956 119 8	4 436 249 85
545	954 889 87	4 429 023 78	605	956 119	4 436 249 77
546	954 517 06	4 429 733 89			
547	954 514 78	4 429 733 19			
548	954 637 5	4 429 491 14			
549	954 637 53	4 429 491 13			
550	954 648 53	4 429 371 28			
551	954 665 12	4 429 231 85			
552	954 670 63	4 429 232 47			
553	954 653 22	4 429 378 86			
554	954 633 24	4 429 420 79			
555	954 472 3	4 429 848 12			
556	954 504 04	4 429 762 24			
557	954 506 3	4 429 762 95			
558	954 478 1	4 429 844 35			
559	954 472 31	4 429 848 11			
560	954 381 43	4 430 034 14			
561	954 384 43	4 430 012 63			
562	954 384 35	4 430 008 41			
563	954 400 68	4 429 986 35			
564	954 416 31	4 429 951 17			
565	954 420 15	4 429 956 5			
566	954 441 49	4 429 935 78			
567	954 412 82	4 430 018 07			
568	954 409 37	4 430 022 45			
569	954 406 27	4 430 026 11			
570	954 402 64	4 430 029 48			
571	954 401 16	4 430 030 53			
572	954 389 33	4 430 020 22			
573	954 388 63	4 430 017 3			
574	954 391 37	4 430 016 65			
575	954 392 45	4 430 014 09			
576	954 395 34	4 430 014 68			
577	954 393 36	4 430 019 08			
578	954 288 41	4 430 439 08			
579	954 287 81	4 430 438 96			
580	954 290 42	4 430 405 9			
581	954 304 82	4 430 236 63			
582	954 305 88	4 430 249 64			
583	954 308	4 430 251 47			
584	954 293 11	4 430 406 31			
585	954 289 64	4 430 432 01			
586	954 279 75	4 430 539 49			
587	954 284 36	4 430 479 53			
588	954 286 37	4 430 465 41			
589	954 282 06	4 430 537 73			
590	954 271 86	4 430 708 91			
591	954 270 59	4 430 708 88			
592	954 270 07	4 430 665 37			
593	954 278 93	4 430 550 15			
594	954 281 18	4 430 548 42			
595	954 271 6	4 430 664 72			
596	954 873 14	4 434 696 4			
597	954 875 71	4 434 696 82			

Перечень координат поворотных точек земельного участка 86:04:0000001:109986-3У1

Номер	X	Y	Номер	X	Y
1	985 422 34	4 445 702 86	53	984 889 62	4 443 993 05
2	985 426 73	4 445 716 3	54	984 922 38	4 444 142 12
3	985 354 32	4 445 859 41	55	984 921 4	4 444 142 37
4	985 270 55	4 445 967 61	56	984 941 44	4 444 215 03
5	985 201 81	4 446 026 06	57	984 987 32	4 444 345 32
6	985 195 9	4 446 031 06	58	985 054 5	4 444 446 03
7	985 152 9	4 446 044 6	59	985 048 49	4 444 448 03
8	985 158 16	4 446 039 5	60	984 990 48	4 444 345 16
9	985 178 28	4 446 025 64	61	984 938 29	4 444 221 13
10	985 203 88	4 446 016 88	62	984 913 19	4 444 145 82
11	985 261 64	4 445 962 31	63	984 885 65	4 443 992 39
12	985 348 93	4 445 852 65	64	984 807 96	4 443 891 9
13	985 077 66	4 444 499 93	65	981 736 25	4 443 836 89
14	985 083 96	4 444 497 93	66	981 737 98	4 443 839 12
15	985 107 4	4 444 538 21	67	981 711 58	4 443 845 01
16	985 116 94	4 444 570 74	68	981 710 84	4 443 842 98
17	985 127 12	4 444 568 79	69	981 734 23	4 443 831 2
18	985 131 74	4 444 585 3	70	981 708 68	4 443 837 18
19	985 124 5	4 444 587 6	71	981 706 56	4 443 831 34
20	985 423 39	4 445 499 89	72	981 731 96	4 443 825 2
21	985 472 02	4 445 637 85	73	981 798 22	4 443 821 94
22	985 431 09	4 445 710 23	74	981 799 22	4 443 824 63
23	985 426 38	4 445 696 3	75	981 777 1	4 443 829 70
24	985 462 98	4 445 634 5	76	981 776 18	4 443 827 24
25	985 102 34	4 444 545 96	77	981 794 18	4 443 810 67
26	985 060 04	4 444 456 78	78	981 796 37	4 443 816 89
27	985 078 4	4 444 488 13	79	981 774 17	4 443 821 87
28	985 072 19	4 444 490 11	80	981 771 8	4 443 815 48
29	985 053 02	4 444 457 82	81	982 273 91	4 443 724 35
30	980 890 43	4 444 065 02	82	982 271 24	4 443 724 75
31	980 889 5	4 444 067	83	982 218 42	4 443 737 16
32	980 888 28	4 444 069 61	84	982 158 69	4 443 750 59
33	980 885 58	4 444 128 82	85	982 161 47	4 443 763 73
34	980 777 19	4 444 515 19	86	982 131 95	4 443 756 46
35	980 777 13	4 444 548 39	87	982 271 99	4 443 719 97
36	980 764 64	4 444 593 18	88	982 897 88	4 443 586 89
37	980 763 86	4 444 593 05	89	982 890 38	4 443 606 2
38	980 763 55	4 444 595 2	90	982 125 78	4 443 732 25
39	980 764 14	4 444 595 32	91	981 908 26	4 443 607 34
40	980 761 8	4 444 605 19	92	981 807 02	4 443 602 62
41	980 762 02	4 444 556 24	93	981 918 26	4 443 778 08
42	980 762 51	4 444 558 37	94	981 917 46	4 443 773 26
43	980 782 41	4 444 470 49	95	981 918 81	4 443 770 47
44	980 857 63	4 444 133 34	96	982 264 9	4 443 683 48
45	980 882 02	4 444 061 7	97	982 265 54	4 443 682 21
46	980 904 66	4 444 035 11	98	982 266 02	4 443 694 27
47	980 962 94	4 444 067 18	99	982 448 53	4 443 643 7
48	980 980 78	4 443 997 93	100	982 449 05	4 443 645 63
49	981 060 42	4 443 974 77	101	982 594 68	4 443 604 88

Перечень координат поворотных точек земельного участка № 04:0000001:109986.3У1

Перечень координат поворотных точек земельного участка № 04:0000001:36247.3У1

Номер	X	Y	Номер	X	Y
105	984 511	4 443 488 97	164	984 112 03	4 443 240 79
106	984 504 75	4 443 510 12	165	984 119 61	4 443 238 51
107	984 503 45	4 443 513 32	166	980 761 52	4 444 664 44
108	984 501 3	4 443 511 94	167	980 761 72	4 444 622 75
109	984 502 07	4 443 509 95	168	980 777 08	4 444 657 85
110	984 503 09	4 443 508 62	169	980 777 08	4 444 664 83
111	984 503 85	4 443 504 12	170	980 777 14	4 444 587 78
112	984 509 45	4 443 485 76	171	980 777 07	4 444 588 02
113	983 682 34	4 443 391 72	172	980 767 31	4 444 618 99
114	983 682 16	4 443 394 6	173	980 767 49	4 444 621 95
115	983 670 01	4 443 396 82	174	980 763 47	4 444 622 08
116	983 670 15	4 443 394 58	175	980 763 41	4 444 619 09

117	983 569 5	4 443 386 68
118	983 011 21	4 443 518 51
119	983 010 06	4 443 513 17
120	983 566 86	4 443 394 33
121	983 569 8	4 443 391 18
122	983 694 99	4 443 388 7
123	983 694 87	4 443 392 28
124	983 688 23	4 443 393 5
125	983 688 4	4 443 390 29
126	983 683 2	4 443 377 17
127	983 682 78	4 443 384 83
128	983 678 47	4 443 385 54
129	983 679 01	4 443 388 46
130	983 670 5	4 443 380 49
131	983 670 45	4 443 390 5
132	983 671 12	4 443 379 38
133	983 688 74	4 443 388 15
134	983 689 24	4 443 376 08
135	983 695 86	4 443 374 56
136	983 695 31	4 443 382 82
137	983 689 26	4 443 383 3
138	983 690 25	4 443 383 75
139	983 690 54	4 443 385 72
140	984 045 08	4 443 279 78
141	984 041 87	4 443 288 89
142	983 713 17	4 443 368 93
143	983 812 86	4 443 338 3
144	983 838 54	4 443 331 92
145	984 495 67	4 443 481 46
146	984 489 92	4 443 482 86
147	984 494 88	4 443 465 88
148	984 484 92	4 443 422 81
149	984 431 98	4 443 389 85
150	984 367 79	4 443 266 74
151	984 371 1	4 443 267 36
152	984 502 04	4 443 469 87
153	984 496 03	4 443 478 77
154	984 494 75	4 443 478 91
155	984 496 58	4 443 475 86
156	984 497 87	4 443 477 56
157	984 194 6	4 443 252 55
158	984 193 98	4 443 255 87
159	984 193 1	4 443 255 7
160	984 192 37	4 443 259 8

Номер	X	Y
60	983 696 29	4 443 370 37
61	983 633 63	4 443 376 85
62	983 633 84	4 443 372 96
63	983 637 38	4 443 372 32
64	983 643 64	4 443 377 29
65	983 671 53	4 443 372 2
66	983 671 54	4 443 375 38
67	983 644 18	4 443 386 89
68	983 587 49	4 443 384 46
69	983 587 03	4 443 382 86
70	983 569 5	4 443 396 68
71	983 569 8	4 443 391 18
72	983 568 96	4 443 394 33
73	983 010 06	4 443 513 17
74	982 687 11	4 443 583 3
75	982 653	4 443 592 59
76	982 652 88	4 443 588 58
77	983 144 11	4 443 481 77
78	983 328 91	4 443 441 59
79	983 516 88	4 443 400 38
80	983 562 03	4 443 382 14
81	983 569 28	4 443 384 73
82	983 584 57	4 443 382 03
83	984 520 06	4 443 436 23
84	984 523 66	4 443 438 58
85	984 522 11	4 443 486 73
86	984 569 01	4 443 544 31
87	984 556 28	4 443 546 06
88	984 519 5	4 443 486 62
89	984 520 22	4 443 460 01
90	984 518 59	4 443 459 8
91	984 558 11	4 443 558 74
92	984 564 39	4 443 552 71
93	984 639 68	4 443 670 17
94	984 772 97	4 443 843 24
95	984 772 84	4 443 848 3
96	984 772 75	4 443 848 18
97	984 636 08	4 443 868 84
98	984 558 12	4 443 558 74
99	984 581 88	4 443 584 48
100	984 817 07	4 443 641 53
101	982 603 28	4 443 603 07
102	982 604 68	4 443 604 88

Номер	X	Y
1	984 093 8	4 443 220 18
2	984 089 36	4 443 221 53
3	984 088 44	4 443 218 8
4	984 092 87	4 443 218 1
5	984 088 36	4 443 221 88
6	984 088 96	4 443 221 88
7	984 088 34	4 443 221 85
8	984 084 04	4 443 229 13
9	984 053 17	4 443 258 16
10	984 058 43	4 443 229 64
11	984 087 37	4 443 218 86
12	984 245 89	4 443 236 86
13	984 242 52	4 443 236 03
14	984 242 9	4 443 233 88
15	984 228 15	4 443 231 24
16	984 227 02	4 443 233 14
17	984 220 88	4 443 232
18	984 228 55	4 443 227 77
19	984 243 84	4 443 230 58
20	984 246 3	4 443 233 51
21	984 248 57	4 443 262 08
22	984 242 95	4 443 280 85
23	984 247 88	4 443 257 79
24	984 257 27	4 443 251 89
25	984 267 74	4 443 244 72
26	984 263 69	4 443 250 01
27	984 257 65	4 443 255 67
28	984 361 56	4 443 264 67
29	984 344 37	4 443 251 18
30	984 342 31	4 443 247 88
31	984 344 46	4 443 248 14
32	984 348 81	4 443 248 99
33	984 353 21	4 443 250 4
34	984 336 44	4 443 278 21
35	984 328 81	4 443 276 81
36	984 318 31	4 443 260 94
37	984 310 36	4 443 248 99
38	984 317 7	4 443 250 09
39	984 322 59	4 443 257 57
40	984 498 81	4 443 452 07
41	984 498 88	4 443 452 93
42	984 497 57	4 443 456 63
43	984 368 1	4 443 256
44	984 374 21	4 443 261 99
45	984 380 3	4 443 268 59
46	984 083 82	4 443 290 77
47	984 082 44	4 443 283 1
48	984 081 72	4 443 279 55
49	984 082 84	4 443 279 41
50	984 082 74	4 443 278 34
51	984 084 77	4 443 277 93
52	984 084 74	4 443 285 04
53	984 086 33	4 443 285 04
54	984 085 83	4 443 290 28
55	983 696 27	4 443 370 41
56	983 696 22	4 443 370 42
57	983 696 46	4 443 367 28

Перечень координат поворотных точек земельного участка 86:04:000001:36247-3/1

Номер	X	Y	Номер	X	Y
105	982 266 02	4 443 694 27	164	985 431 09	4 445 710 23
106	982 265 54	4 443 692 21	165	985 472 02	4 445 837 05
107	982 594 21	4 443 601 35	166	985 423 36	4 445 490 80
108	982 594 35	4 443 601 34	167	985 424 52	4 445 490 61
109	982 594 37	4 443 601 31	168	985 473 5	4 445 638 05
110	982 683 17	4 443 599 4	169	985 209 29	4 446 023 7
111	982 351 9	4 443 699 64	170	985 201 81	4 446 026 06
112	982 278 06	4 443 719 94	171	985 270 56	4 445 967 61
113	982 273 01	4 443 724 35	172	985 354 32	4 445 859 41
114	982 271 99	4 443 719 97	173	985 426 73	4 445 716 3
115	982 131 95	4 443 756 46	174	985 426 42	4 445 721 27
116	982 352 09	4 443 699 1	175	985 356 61	4 445 861 28
117	982 131 95	4 443 756 46	176	985 272 56	4 445 866 63

Номер	X	Y
118	982 161 47	4 443 763 73
119	982 158 69	4 443 760 59
120	982 216 42	4 443 737 18
121	982 271 23	4 443 724 75
122	982 265 85	4 443 728 56
123	981 928 35	4 443 806 67
124	981 928 06	4 443 804 66
125	981 867 02	4 443 802 62
126	981 060 42	4 443 974 77
127	980 960 78	4 443 987 93
128	980 832 53	4 444 014 37
129	980 978 24	4 444 017 75
130	980 958 71	4 443 995 93
131	981 021 83	4 443 981 27
132	981 073 85	4 443 968 17
133	981 073 89	4 443 969 17
134	981 916 46	4 443 773 26
135	981 916 26	4 443 776 66
136	981 777 4	4 443 830 56
137	981 777 1	4 443 829 76
138	981 799 22	4 443 824 63
139	981 799 52	4 443 825 44
140	981 711 67	4 443 845 62
141	981 711 58	4 443 845 01
142	981 737 08	4 443 838 12
143	981 737 37	4 443 839 89
144	984 802 23	4 443 864 44
145	984 783 23	4 443 859 72
146	984 783 17	4 443 859 65
147	984 783 32	4 443 856 4
148	984 802 43	4 443 860 68
149	984 806 12	4 443 867 92
150	984 818 1	4 443 866 91
151	984 822 16	4 443 900 85
152	984 825 11	4 443 896 68
153	984 828 14	4 443 913 74
154	980 911 08	4 444 021 61
155	980 908 26	4 444 027 53
156	980 879 82	4 444 060 41
157	980 856 22	4 444 132 68
158	980 762 96	4 444 549 65
159	980 780 26	4 444 542 19
160	980 852 16	4 444 131 04
161	980 876 9	4 444 058 5

Номер	X	Y
60	980 879 82	4 444 060 41
61	980 908 26	4 444 027 53
62	980 904 66	4 444 035 11
63	980 882 02	4 444 061 7
64	980 857 63	4 444 133 34
65	980 782 41	4 444 470 49

Перечень координат поворотных точек земельного участка 86:04:000001:109990-3/1

Номер	X	Y
1	957 322 95	4 412 562 96
2	957 325 45	4 412 597 96
3	957 308 64	4 412 602 79
4	957 306 7	4 412 599 11
5	957 304 28	4 412 575 78
6	957 314 07	4 412 677 96
7	957 316 74	4 412 679 46
8	957 331 19	4 412 632 49
9	957 338 39	4 412 675 79
10	957 350 84	4 412 927 39
11	957 335 99	4 412 098
12	957 330 12	4 413 007 37
13	957 319 39	4 413 022 15
14	957 312 65	4 413 028 05
15	957 313 61	4 413 023 39
16	957 333 74	4 412 926 09
17	957 321 47	4 412 677 96
18	957 316 36	4 412 656 24
19	957 317 75	4 412 656 63
20	957 314 68	4 412 637 39
21	957 329 13	4 412 998 33
22	957 326 88	4 412 997 87
23	957 327 34	4 412 995 7
24	957 329 59	4 412 996 18
25	957 329 47	4 412 679 8
26	957 329 32	4 412 676 77
27	957 328 81	4 412 673 77
28	957 330 98	4 412 673 41
29	957 331 52	4 412 676 56
30	957 331 67	4 412 679 68
31	957 341 21	4 412 925 67
32	957 340 65	4 412 918 38
33	957 343 84	4 412 918 23
34	957 344 22	4 412 925 81

Перечень координат поворотных точек земельного участка 86:04:000001:109981-3/1

Номер	X	Y
1	984 242 62	4 443 236 03
2	984 227 02	4 443 233 14
3	984 228 15	4 443 231 24
4	984 242 9	4 443 233 96
5	984 302 04	4 443 469 97
6	984 371 1	4 443 267 36
7	984 367 79	4 443 266 74
8	984 362 7	4 443 258 55
9	984 347 04	4 443 255 8
10	984 344 37	4 443 251 19
11	984 361 56	4 443 254 87
12	984 366 1	4 443 256
13	984 497 57	4 443 456 83
14	984 500 46	4 443 461 11
15	984 503 92	4 443 463 55
16	983 689 24	4 443 376 06
17	983 689 44	4 443 372 4
18	983 696 22	4 443 370 42
19	983 696 27	4 443 370 41
20	983 695 96	4 443 374 56
21	983 671 12	4 443 379 36
22	983 671 35	4 443 375 36
23	983 683 4	4 443 373 5
24	983 683 2	4 443 377 17
25	983 633 63	4 443 376 65
26	983 644 18	4 443 380 89
27	983 633 33	4 443 383 09
28	984 522 39	4 443 548 57
29	984 511	4 443 448 97
30	984 509 45	4 443 485 76
31	984 516 18	4 443 483 36
32	984 517 06	4 443 461 41
33	984 517 52	4 443 459 1
34	984 518 59	4 443 459 8
35	984 529 22	4 443 460 01
36	984 519 5	4 443 486 82
37	984 566 29	4 443 546 06
38	982 697 88	4 443 546 89
39	982 697 11	4 443 583 3
40	983 010 06	4 443 513 17
41	983 011 21	4 443 518 51
42	984 561 66	4 443 554 46
43	984 617 07	4 443 641 53
44	984 558 12	4 443 656 74
45	981 062 5	4 443 963 64
46	981 080 42	4 443 874 77
47	981 807 92	4 443 802 62
48	981 808 26	4 443 807 34
49	981 794 16	4 443 810 67
50	981 771 6	4 443 815 46
51	981 731 96	4 443 825 2
52	981 706 56	4 443 831 34
53	980 960 78	4 443 997 93
54	980 962 94	4 444 007 18
55	980 832 53	4 444 014 37
56	980 782 51	4 444 559 37
57	980 782 92	4 444 559 24

Перечень координат поворотных точек
земельного участка 86-04-0000001-109990-3У1

Номер	X	Y
37	957 342.51	4 412 935.42
38	957 339.58	4 412 934.81
39	957 340.95	4 412 928.17
40	957 341.26	4 412 926.66
41	957 333.43	4 412 761
42	957 333.32	4 412 758.8
43	957 335.62	4 412 758.69
44	957 335.73	4 412 760.89
45	957 337.54	4 412 844.2
46	957 337.43	4 412 842.01
47	957 339.72	4 412 841.89
48	957 339.84	4 412 844.09
49	957 260.33	4 413 110.43
50	957 260.84	4 413 090.21
51	957 306.54	4 413 062.22
52	957 307.94	4 413 055.44
53	957 330.92	4 413 028.53
54	957 321.75	4 413 072.87
55	957 312.7	4 413 064.72
56	957 313.95	4 413 058.64
57	957 316.89	4 413 059.25
58	957 315.39	4 413 066.51
59	957 315.05	4 413 068.19
60	957 313.94	4 413 068.66
61	957 307.24	4 413 072.97
62	957 305.66	4 413 070.42
63	957 311.34	4 413 066.94
64	957 312.37	4 413 066.32
65	957 275.04	4 412 549.97
66	957 275.52	4 412 530.78
67	957 316.03	4 412 541.36
68	957 319.61	4 412 562.9
69	957 315.52	4 412 561.94
70	957 301.38	4 412 558.62
71	957 300.94	4 412 556
72	957 306.21	4 412 549.68
73	957 300.24	4 412 548.1
74	957 301	4 412 545.2
75	957 308.84	4 412 547.25
76	957 310.16	4 412 547.6
77	957 310.4	4 412 549.02
78	957 311.74	4 412 556.94
79	957 308.78	4 412 557.45
80	957 307.78	4 412 551.49
81	957 307.53	4 412 550.03
82	957 315.72	4 412 572.26
83	957 321.39	4 412 573.58
84	957 321.67	4 412 575.28
85	957 321.06	4 412 574.89
86	957 320.06	4 412 574.24
87	957 311.92	4 412 571.37

Перечень координат поворотных точек
земельного участка 86-04-0000001-109989-3У1

Номер	X	Y
1	957 260.16	4 413 117.12
2	957 260.33	4 413 110.43
3	957 321.75	4 413 072.87
4	957 330.92	4 413 028.53
5	957 333.18	4 413 041.68
6	957 326.53	4 413 077.5
7	957 313.61	4 413 023.39
8	957 311.64	4 413 014.65
9	957 330.09	4 412 925.52
10	957 318.19	4 412 684.15
11	957 311.43	4 412 675.54
12	957 308.91	4 412 680.82
13	957 318.36	4 412 659.24
14	957 321.47	4 412 677.66
15	957 333.74	4 412 926.09
16	957 275.67	4 412 524.68
17	957 294.82	4 412 529.6
18	957 301.9	4 412 535.03
19	957 315.58	4 412 538.64
20	957 316.03	4 412 541.36
21	957 275.52	4 412 530.78

Перечень координат поворотных точек земельного участка
86-04-0000001-110005-3У1

Номер	X	Y
1	955 587.94	4 416 553.65
2	955 585.74	4 416 552.97
3	955 586.4	4 416 550.87
4	955 588.6	4 416 551.55
5	955 586.77	4 416 622.38
6	955 584.63	4 416 621.82
7	955 585.44	4 416 618.8
8	955 586.37	4 416 615.82
9	955 588.47	4 416 616.48
10	955 587.55	4 416 619.42
11	955 544.74	4 416 705.37
12	955 542.52	4 416 704.79
13	955 543.08	4 416 702.66
14	955 545.31	4 416 703.25
15	955 522.13	4 416 790.41
16	955 519.91	4 416 788.83
17	955 520.47	4 416 787.71
18	955 522.7	4 416 788.29
19	955 498.02	4 416 882.39
20	955 495.12	4 416 881.61
21	955 499.49	4 416 885.18
22	955 502.39	4 416 885.94
23	955 475.4	4 416 967.43
24	955 472.5	4 416 966.68
25	955 476.88	4 416 950.23
26	955 479.78	4 416 951
27	955 368.68	4 417 235.65
28	955 367.53	4 417 232.87
29	955 371.38	4 417 231.35
30	955 372.48	4 417 234.15
31	955 360.13	4 417 239.02
32	955 361.3	4 417 235.33
33	955 365.17	4 417 233.8
34	955 366.38	4 417 236.55
35	955 326.6	4 417 252.24
36	955 327.69	4 417 248.58
37	955 331.59	4 417 247.02
38	955 332.89	4 417 249.82
39	955 363.12	4 417 389.7
40	955 360.24	4 417 388.87
41	955 362.11	4 417 381.87
42	955 365.01	4 417 382.63
43	955 359.16	4 417 398.81
44	955 356.44	4 417 397.56
45	955 359.36	4 417 391.24
46	955 362.22	4 417 392.21
47	955 251.52	4 417 631.2
48	955 248.65	4 417 630.27
49	955 251.87	4 417 623.3
50	955 254.59	4 417 624.56
51	955 248.91	4 417 640.29
52	955 246.02	4 417 639.51
53	955 247.86	4 417 632.57
54	955 250.73	4 417 633.45
55	955 077.5	4 418 762.74
56	955 075.09	4 418 760.96

Номер	X	Y
60	954 857.36	4 420 606.47
61	954 857.98	4 420 599.45
62	954 860.97	4 420 599.71
63	954 857.86	4 420 616.62
64	954 854.97	4 420 615.81
65	954 856.91	4 420 608.99
66	954 859.84	4 420 609.6
67	954 741.35	4 421 024.22
68	954 738.27	4 421 024.22
69	954 740.34	4 421 016.9
70	954 743.22	4 421 017.73
71	954 739	4 421 034.14
72	954 738.1	4 421 026.79
73	954 741.1	4 421 026.79
74	954 741.97	4 421 033.76
75	954 791.24	4 421 448.09
76	954 790.35	4 421 440.95
77	954 793.32	4 421 440.57
78	954 794.24	4 421 448.07
79	954 793.54	4 421 457.77
80	954 790.56	4 421 457.47
81	954 791.26	4 421 450.46
82	954 794.27	4 421 450.46
83	954 770.4	4 421 702.01
84	954 767.38	4 421 702.01
85	954 768.08	4 421 694.67
86	954 771.08	4 421 694.96
87	954 768.42	4 421 711.85
88	954 767.44	4 421 704.47
89	954 770.44	4 421 704.43
90	954 771.4	4 421 711.44
91	954 822.93	4 422 119.61
92	954 821.9	4 422 112.71

Перечень координат поворотных точек земельного участка 86:04:0060001:110005:3У1

Номер	X	Y	Номер	X	Y	Номер	X	Y
94	954 825.85	4 422 119.09	154	955 745.95	4 427 054.77	214	954 292.13	4 430 097.87
95	954 826.1	4 422 129.38	155	955 743.9	4 427 064.93	215	954 292.2	4 430 093.86
96	954 823.56	4 422 122.33	156	955 740.98	4 427 064.26	216	954 295.19	4 430 094
97	954 826.48	4 422 121.68	157	955 742.42	4 427 057.93	217	954 294.89	4 430 110.87
98	954 828.92	4 422 128.36	158	955 745.53	4 427 057.7	218	954 291.92	4 430 110.73
99	954 974.15	4 422 522.8	159	955 713.06	4 427 198.33	219	954 292.01	4 430 105.42
100	954 971.07	4 422 522.8	160	955 710.26	4 427 197.38	220	954 294.99	4 430 105.48
101	954 968.86	4 422 516.73	161	955 711.77	4 427 190.74	221	954 294.25	4 430 150.19
102	954 971.67	4 422 515.69	162	955 714.7	4 427 181.41	222	954 291.26	4 430 150.09
103	954 970.3	4 422 532.27	163	955 708.28	4 427 207.38	223	954 291.37	4 430 143.75
104	954 967.65	4 422 530.87	164	955 705.71	4 427 205.82	224	954 294.36	4 430 143.88
105	954 970.7	4 422 525.51	165	955 709.05	4 427 200.29	225	954 294.18	4 430 154.27
106	954 973.99	4 422 525.51	166	955 711.84	4 427 201.45	226	954 291.18	4 430 154.64
107	954 541.92	4 423 179.1	167	955 573.05	4 427 431.38	227	954 291.22	4 430 152.48
108	954 539.43	4 423 177.43	168	955 570.29	4 427 430.15	228	954 294.21	4 430 152.52
109	954 549.2	4 423 163.5	169	955 573.89	4 427 424.15	229	954 290.26	4 430 205.4
110	954 551.69	4 423 165.17	170	955 578.46	4 427 425.68	230	954 293.25	4 430 205.38
111	954 506.49	4 423 229.18	171	955 569.81	4 427 440.66	231	954 293.19	4 430 208.78
112	954 504	4 423 227.51	172	955 566.94	4 427 439.77	232	954 290.2	4 430 208.64
113	954 513.86	4 423 213.61	173	955 569.06	4 427 432.89	233	954 292.72	4 430 233.14
114	954 516.34	4 423 215.29	174	955 571.85	4 427 433.91	234	954 289.73	4 430 232.91
115	954 479.49	4 423 267.26	175	955 385.38	4 428 034.48	235	954 289.87	4 430 226.38
116	954 476.97	4 423 265.63	176	955 382.63	4 428 033.4	236	954 292.86	4 430 226.51
117	954 478.39	4 423 283.62	177	955 384.75	4 428 026.59	237	954 292.07	4 430 243.37
118	954 480.88	4 423 285.29	178	955 387.56	4 428 027.58	238	954 289.09	4 430 243.23
119	954 471.33	4 423 278.83	179	955 379.86	4 428 042.95	239	954 289.61	4 430 235.97
120	954 468.83	4 423 277.16	180	955 377.37	4 428 041.13	240	954 292.58	4 430 236.31
121	954 472.87	4 423 271.44	181	955 381.36	4 428 035.83	241	954 286.48	4 430 316.68
122	954 475.35	4 423 273.13	182	955 384.18	4 428 037	242	954 283.5	4 430 316.45
123	954 410.55	4 423 385.24	183	954 678.74	4 429 021.37	243	954 283.98	4 430 310.09
124	954 407.61	4 423 384.48	184	954 675.71	4 429 020.38	244	954 286.97	4 430 310.23
125	954 410.7	4 423 377.8	185	954 680	4 429 014.28	245	954 285.68	4 430 327.19
126	954 413.41	4 423 379.06	186	954 682.48	4 429 016.11	246	954 282.69	4 430 327.05
127	954 409.11	4 423 394.71	187	954 676.73	4 429 030.87	247	954 283.26	4 430 318.52
128	954 406.13	4 423 394.41	188	954 673.75	4 429 030.44	248	954 286.24	4 430 319.8
129	954 406.94	4 423 387.21	189	954 674.72	4 429 023.51	249	954 269.8	4 430 517.85
130	954 409.8	4 423 387.9	190	954 677.56	4 429 024.28	250	954 286.82	4 430 517.55
131	955 608.93	4 416 486.91	191	954 636.24	4 429 370.79	251	954 267.15	4 430 513.38
132	955 607.47	4 416 488.47	192	954 633.32	4 429 370.19	252	954 270.14	4 430 513.57
133	955 609.09	4 416 484.65	193	954 634.08	4 429 363.67	253	954 262.11	4 430 609.91
134	955 609.58	4 416 484.81	194	954 637.06	4 429 364.09	254	954 259.12	4 430 609.72
135	954 251.55	4 425 314.02	195	954 633.08	4 429 380.66	255	954 259.69	4 430 602.99
136	954 251.87	4 425 306.54	196	954 630.28	4 429 378.66	256	954 262.67	4 430 603.27
137	954 254.87	4 425 306.73	197	954 632.63	4 429 373.19	257	954 257.7	4 430 663.3
138	954 254.45	4 425 313.03	198	954 635.55	4 429 373.92	258	954 254.69	4 430 663.2
139	954 258.22	4 425 321.84	199	954 455.49	4 429 880.81	259	954 255.23	4 430 656.42
140	954 252.34	4 425 316.54	200	954 452.65	4 429 859.81	260	954 258.23	4 430 656.6
141	954 255.5	4 425 315.44	201	954 454.66	4 429 854.34	261	954 254.58	4 430 673.48
142	954 260.19	4 425 319.59	202	954 457.46	4 429 855.34	262	954 254.55	4 430 665.49
143	955 410.81	4 426 008.34	203	954 452.09	4 429 867.61	263	954 257.56	4 430 665.51
144	955 405.23	4 426 006.02	204	954 449.29	4 429 866.41	264	954 257.59	4 430 673.47
145	955 406.76	4 426 003.44	205	954 451.72	4 429 862.36	265	956 177.23	4 415 729.23
146	955 412.5	4 426 006.96	206	954 453.24	4 429 862.97	266	956 175.81	4 415 726.59
147	955 414.43	4 426 017.61	207	954 453.24	4 429 862.97	267	956 184.7	4 415 721.39
148	955 412.51	4 426 011.38	208	954 454.52	4 429 863.49	268	956 186.21	4 415 723.98
149	955 413.68	4 426 010.85	209	954 449.82	4 429 870.47	269	956 218.99	4 415 695.15
150	955 415.79	4 426 017.19	210	954 447.63	4 429 869.18	270	956 221.86	4 415 696.03

Перечень координат поворотных точек
земельного участка
86:04:0000001:110005:3У1

Номер	X	Y
274	956 216.65	4 415 702.7
275	956 216.65	4 415 702.7
276	956 216.67	4 415 702.71
277	956 217.31	4 415 701.84
278	956 219.34	4 415 703.44
279	956 217.87	4 415 705.24
280	956 215.99	4 415 703.63
281	956 216.66	4 415 702.72
282	956 245.25	4 415 482.51
283	956 245.69	4 415 479.52
284	956 248.93	4 415 479.37
285	956 248.07	4 415 482.4
286	956 248.96	4 415 482.37
287	956 249.82	4 415 479.34
288	956 252.72	4 415 479.21
288	956 252.85	4 415 482.21
290	956 242.57	4 415 481.96
291	956 235.84	4 415 479.33
292	956 236.95	4 415 476.54
293	956 243.27	4 415 479.06
294	956 212.47	4 415 469.61
295	956 207.44	4 415 467.62
296	956 207.1	4 415 468.47
297	956 206.32	4 415 468.16
298	956 207.52	4 415 463.79
299	956 208.77	4 415 464.29
300	956 208.26	4 415 465.58
301	956 213.28	4 415 467.57
302	956 498.48	4 414 563.95
303	956 495.56	4 414 563.3
304	956 497.08	4 414 556.62
305	956 500.08	4 414 556.84
306	956 500.34	4 414 553.76
307	956 497.34	4 414 553.6
308	956 497.15	4 414 546.87
309	956 500.14	4 414 546.8
310	956 489.32	4 414 271.2
311	956 489.11	4 414 263.72
312	956 492.12	4 414 264.18
313	956 492.32	4 414 271.11
314	954 259.36	4 425 228.88
315	954 257.07	4 425 228.73
316	954 257.21	4 425 226.55
317	954 259.51	4 425 226.69
318	956 492.61	4 414 261.85
319	956 489.55	4 414 261.32
320	956 492.8	4 414 254.33
321	956 495.52	4 414 255.58

Перечень координат поворотных точек земельного участка 86:04:0000001:110005:3У1

Номер	X	Y	Номер	X	Y
1	984 115.09	4 443 228.94	60	983 476.55	4 443 429.52
2	984 121.11	4 443 228.66	61	983 480.56	4 443 429.42
3	984 120.87	4 443 222.65	62	983 480.5	4 443 426.41
4	984 114.85	4 443 222.93	63	983 476.49	4 443 426.57
5	984 175.45	4 443 238.29	64	984 456.53	4 443 430.89
6	984 179.46	4 443 238.14	65	984 456.28	4 443 426.64
7	984 179.4	4 443 235.13	66	984 453.86	4 443 426.76
8	984 175.39	4 443 235.28	67	983 427.67	4 443 440.48
9	984 069.17	4 443 242.58	68	983 431.68	4 443 440.34
10	984 072.8	4 443 242.44	69	983 431.51	4 443 437.38
11	984 072.61	4 443 241.45	70	983 427.81	4 443 437.48
12	984 074.87	4 443 241.02	71	983 369.29	4 443 453.29
13	984 075.12	4 443 242.35	72	983 373.3	4 443 453.19
14	984 075.19	4 443 242.35	73	983 373.13	4 443 450.19
15	984 074.95	4 443 236.28	74	983 369.11	4 443 450.28
16	984 068.83	4 443 236.56	75	983 310.22	4 443 466.19
17	984 234.67	4 443 249.34	76	983 314.14	4 443 465.92
18	984 238.38	4 443 247.73	77	983 313.96	4 443 462.91
19	984 237.2	4 443 244.98	78	983 309.94	4 443 463.23
20	984 233.49	4 443 246.58	79	983 252.4	4 443 478.84
21	984 293.45	4 443 260.33	80	983 256.41	4 443 478.79
22	984 297.48	4 443 260.17	81	983 256.35	4 443 475.78
23	984 297.41	4 443 257.17	82	983 252.34	4 443 475.94
24	984 293.39	4 443 257.32	83	984 488.54	4 443 480.42
25	984 352	4 443 272.81	84	984 490.3	4 443 480.38
26	984 358.02	4 443 272.64	85	984 490.13	4 443 477.37
27	984 357.89	4 443 266.68	86	984 488.65	4 443 477.51
28	984 351.87	4 443 266.85	87	983 194.02	4 443 491.75
29	984 048.18	4 443 299.51	88	983 198.03	4 443 491.6
30	984 054	4 443 298.1	89	983 197.97	4 443 488.59
31	984 052.64	4 443 292.23	90	983 193.95	4 443 488.74
32	984 046.83	4 443 293.69	91	983 135.63	4 443 504.55
33	984 367.72	4 443 324.4	92	983 139.65	4 443 504.45
34	984 389.61	4 443 324.35	93	983 139.58	4 443 501.45
35	984 389.43	4 443 321.34	94	983 135.57	4 443 501.55
36	984 385.83	4 443 321.48	95	983 077.57	4 443 517.62
37	983 881.01	4 443 339.93	96	983 081.49	4 443 516.81
38	983 884.93	4 443 338.98	97	983 080.76	4 443 513.87
39	983 884.31	4 443 336.04	98	983 076.84	4 443 514.72
40	983 880.4	4 443 336.95	99	984 520.48	4 443 529.76
41	984 422.34	4 443 377.99	100	984 524.5	4 443 529.66
42	984 422.96	4 443 377.97	101	984 524.43	4 443 526.66
43	984 422.78	4 443 374.96	102	984 520.42	4 443 526.75
44	984 420.45	4 443 375.05	103	983 019.08	4 443 530
45	983 716.49	4 443 379.56	104	983 022.99	4 443 529.18
46	983 717.19	4 443 379.4	105	983 022.37	4 443 526.29
47	983 716.27	4 443 375.52	106	983 018.46	4 443 527.14
48	983 710.45	4 443 376.93	107	982 960.37	4 443 542.42
49	983 710.82	4 443 378.45	108	982 964.4	4 443 541.58
50	983 715.95	4 443 377.3	109	982 963.78	4 443 538.67
51	983 567.14	4 443 410.37	110	982 959.86	4 443 539.46
52	983 573.16	4 443 410.19	111	982 901.99	4 443 554.78
53	983 573	4 443 408.17	112	982 905.91	4 443 553.94
54	983 566.98	4 443 406.34	113	982 905.29	4 443 550.96
55	983 521.96	4 443 419.46	114	982 901.38	4 443 551.83
56	983 525.98	4 443 419.37	115	984 554.8	4 443 578.98
			116	984 558.81	4 443 578.89

Номер	X	Y	Номер	X	Y	Номер	X	Y
119	984 589.34	4 443 628.59	178	981 872.35	4 443 807.25	238	984 911.39	4 444 188.83
120	984 593.24	4 443 628.44	179	981 871.63	4 443 804.26	239	984 915.41	4 444 188.68
121	984 593.18	4 443 625.43	180	981 867.81	4 443 805.18	240	984 915.23	4 444 185.67
122	984 589.16	4 443 625.58	181	984 729.78	4 443 815.55	241	984 911.33	4 444 185.82
123	982 489.81	4 443 653.41	182	984 733.68	4 443 815.46	242	984 922.7	4 444 227.7
124	982 493.73	4 443 652.4	183	984 733.62	4 443 812.45	243	984 928.72	4 444 227.52
125	982 493.01	4 443 649.48	184	984 729.6	4 443 812.55	244	984 928.56	4 444 223.5
126	982 489.09	4 443 650.46	185	981 814.72	4 443 821.1	245	984 922.54	4 444 223.67
127	982 435.54	4 443 666.88	186	981 819.53	4 443 820.13	246	984 941.65	4 444 268.84
128	982 439.35	4 443 665.97	187	981 817.91	4 443 817.23	247	984 945.67	4 444 268.74
129	982 438.73	4 443 663.01	188	981 813.09	4 443 818.14	248	984 945.6	4 444 265.73
130	982 434.81	4 443 663.97	189	981 758.78	4 443 834.49	249	984 941.59	4 444 265.82
131	984 622.08	4 443 678.38	190	981 762.69	4 443 833.58	250	980 839.76	4 444 296.3
132	984 626.6	4 443 678.25	191	981 761.96	4 443 830.67	251	980 840.41	4 444 293.38
133	984 627.29	4 443 678.24	192	981 758.06	4 443 831.61	252	980 839.59	4 444 293.19
134	984 628.11	4 443 678.21	193	981 701.27	4 443 848.34	253	980 838.91	4 444 296.08
135	984 627.95	4 443 674.18	194	981 705.19	4 443 847.43	254	984 959.28	4 444 310.54
136	984 621.92	4 443 674.35	195	981 704.45	4 443 844.52	255	984 963.29	4 444 310.44
137	982 378.81	4 443 681.06	196	981 700.65	4 443 845.46	256	984 963.23	4 444 307.43
138	982 382.73	4 443 680.1	197	981 654.52	4 443 859.16	257	984 959.21	4 444 307.53
139	982 382	4 443 677.16	198	981 658.43	4 443 858.25	258	980 826.83	4 444 350.88
140	982 378.08	4 443 678.15	199	981 657.8	4 443 855.75	259	980 827.51	4 444 350.87
141	982 325.31	4 443 694.64	200	981 653.88	4 443 856.66	260	980 828.19	4 444 347.85
142	982 329.22	4 443 693.69	201	984 765.15	4 443 861.52	261	980 826.76	4 444 347.88
143	982 328.49	4 443 690.78	202	984 769.17	4 443 861.37	262	984 975.32	4 444 352.81
144	982 324.58	4 443 691.68	203	984 768.99	4 443 858.36	263	984 981.34	4 444 352.63
145	984 658.91	4 443 723.72	204	984 765.09	4 443 858.52	264	984 981.18	4 444 348.61
146	984 662.92	4 443 723.63	205	984 796.26	4 443 902.11	265	984 975.16	4 444 348.78
147	984 662.86	4 443 720.62	206	984 800.16	4 443 902.01	266	985 004.75	4 444 401.84
148	984 658.85	4 443 720.72	207	984 800.1	4 443 899	267	985 008.76	4 444 401.74
149	982 211.27	4 443 724.39	208	984 796.09	4 443 899.15	268	985 008.7	4 444 398.74
150	982 215.07	4 443 723.38	209	984 835.9	4 443 953.34	269	985 004.68	4 444 398.83
151	982 214.34	4 443 720.46	210	984 839.91	4 443 953.24	270	980 814.16	4 444 405.21
152	982 210.53	4 443 721.48	211	984 839.85	4 443 950.24	271	980 815.34	4 444 405.18
153	982 153.76	4 443 738.56	212	984 835.84	4 443 950.34	272	980 816.02	4 444 402.13
154	982 157.77	4 443 738.41	213	984 870.82	4 444 000.31	273	980 814.09	4 444 402.2
155	982 157.7	4 443 735.45	214	984 872.3	4 444 000.25	274	985 032.71	4 444 451.43
156	982 153.69	4 443 735.55	215	984 872.26	4 444 000.2	275	985 036.72	4 444 451.33
157	982 092.51	4 443 755.57	216	984 874.14	4 443 998.89	276	985 036.6	4 444 449.16
158	982 098.54	4 443 755.39	217	984 875.09	4 444 000.12	277	985 036.58	4 444 448.93
159	982 098.3	4 443 749.38	218	984 876.84	4 444 000.03	278	985 036.55	4 444 448.32
160	982 092.38	4 443 749.55	219	984 876.7	4 443 994.61	279	985 032.65	4 444 448.42
161	982 047.21	4 443 765.26	220	984 870.88	4 443 994.79	280	980 801.15	4 444 459.43
162	982 051.14	4 443 764.36	221	980 917.85	4 444 031.08	281	980 803.23	4 444 459.38
163	982 050.41	4 443 761.39	222	980 919.89	4 444 028.58	282	980 803.91	4 444 456.36
164	982 046.59	4 443 762.3	223	980 923.11	4 444 027.61	283	980 801.11	4 444 456.42
165	984 694.29	4 443 769.64	224	980 919.19	4 444 023.25	284	980 801.09	4 444 456.47
166	984 698.3	4 443 769.55	225	980 914.56	4 444 027.32	285	985 047.61	4 444 462.52
167	984 698.24	4 443 766.54	226	984 878.94	4 444 050.19	286	985 053.63	4 444 462.24
168	984 694.23	4 443 766.64	227	984 884.85	4 444 050.02	287	985 053.39	4 444 478.22
169	981 985.24	4 443 779.79	228	984 884.8	4 444 045.99	288	985 047.37	4 444 478.56
170	981 989.15	4 443 778.94	229	984 878.78	4 444 046.21	289	980 788.37	4 444 513.54
171	981 988.53	4 443 775.97	230	984 889.51	4 444 100.1	290	980 792.39	4 444 513.44
172	981 984.62	4 443 776.82	231	984 893.41	4 444 099.95	291	980 792.32	4 444 510.43
173	981 926.61	4 443 793.83	232	984 893.35	4 444 096.95	292	980 788.31	4 444 510.59
174	981 930.53	4 443 792.93	233	984 889.33	4 444 097.09	293	985 068.61	4 444 515.7
175	981 929.8	4 443 789.96	234	984 897.8	4 444 152.88	294	985 072.82	4 444 515.6

Перечень координат поворотных точек земельного участка № 04-0060001-110005-3У1

Лист 97 из 134

Номер	X	Y	Номер	X	Y	Номер	X	Y
298	985 093.21	4 444 552.03	358	985 335.09	4 445 287.42	418	985 217.51	4 445 990.87
299	985 092.93	4 444 547.11	359	985 354.1	4 445 347.32	419	985 217.45	4 445 987.86
300	985 092.36	4 444 547.4	360	985 358.12	4 445 347.17	420	985 213.44	4 445 987.96
301	985 091.56	4 444 546.04	361	985 358.11	4 445 346.78	421	985 174.75	4 446 024.82
302	985 086.82	4 444 546.29	362	985 356.8	4 445 347.2	422	985 178.76	4 446 024.72
303	980 781.04	4 444 567.79	363	985 356.06	4 445 345.2	423	985 178.59	4 446 021.71
304	980 781.09	4 444 564.84	364	985 358.06	4 445 344.52	424	985 174.68	4 446 021.82
305	980 777.08	4 444 564.83	365	985 358.05	4 445 344.22			
306	980 777.14	4 444 567.78	366	985 354.04	4 445 344.32			
307	985 108.01	4 444 609.09	367	985 373.06	4 445 404.17			
308	985 112.03	4 444 608.99	368	985 377.07	4 445 404.07			
309	985 111.96	4 444 605.98	369	985 377.01	4 445 401.07			
310	985 107.95	4 444 606.08	370	985 373	4 445 401.21			
311	985 126.42	4 444 664.38	371	985 392.01	4 445 461.06			
312	985 130.43	4 444 664.22	372	985 396.02	4 445 460.96			
313	985 130.37	4 444 661.22	373	985 395.96	4 445 457.96			
314	985 126.35	4 444 661.37	374	985 391.94	4 445 458.06			
315	985 145.48	4 444 721.23	375	985 410.96	4 445 517.97			
316	985 149.49	4 444 721.14	376	985 414.97	4 445 517.81			
317	985 149.32	4 444 718.12	377	985 414.81	4 445 514.81			
318	985 145.3	4 444 718.22	378	985 410.89	4 445 514.86			
319	985 164.42	4 444 778.14	379	985 429.92	4 445 574.8			
320	985 168.43	4 444 777.98	380	985 433.93	4 445 574.71			
321	985 168.25	4 444 775.03	381	985 433.87	4 445 571.7			
322	985 164.35	4 444 775.13	382	985 429.85	4 445 571.85			
323	985 183.35	4 444 834.99	383	985 447.4	4 445 633.23			
324	985 187.38	4 444 834.89	384	985 453.42	4 445 632.95			
325	985 187.31	4 444 831.88	385	985 453.18	4 445 628.94			
326	985 183.29	4 444 831.98	386	985 447.16	4 445 627.22			
327	985 202.3	4 444 891.9	387	985 423	4 445 686.33			
328	985 206.32	4 444 891.74	388	985 426.76	4 445 685.06			
329	985 206.25	4 444 888.74	389	985 425.8	4 445 682.21			
330	985 202.24	4 444 888.88	390	985 422	4 445 683.38			
331	985 221.25	4 444 948.74	391	985 394.25	4 445 740.41			
332	985 225.26	4 444 948.64	392	985 398.26	4 445 740.26			
333	985 225.19	4 444 945.64	393	985 398.2	4 445 737.26			
334	985 221.18	4 444 945.74	394	985 394.18	4 445 737.41			
335	985 240.2	4 445 005.64	395	985 366.89	4 445 794.66			
336	985 244.21	4 445 005.5	396	985 371	4 445 794.56			
337	985 244.15	4 445 002.49	397	985 370.94	4 445 791.55			
338	985 240.13	4 445 002.64	398	985 366.93	4 445 791.65			
339	985 259.14	4 445 062.49	399	985 338.38	4 445 850.55			
340	985 263.15	4 445 062.4	400	985 343.87	4 445 850.29			
341	985 263.09	4 445 059.39	401	985 344.29	4 445 850.27			
342	985 259.08	4 445 059.49	402	985 344.26	4 445 849.6			
343	985 278.3	4 445 119.77	403	985 344.05	4 445 844.26			
344	985 282.32	4 445 119.67	404	985 338.03	4 445 844.6			
345	985 282.15	4 445 116.67	405	985 310.65	4 445 885			
346	985 278.12	4 445 116.77	406	985 314.66	4 445 884.85			
347	985 297.25	4 445 176.68	407	985 314.6	4 445 881.84			
348	985 301.27	4 445 176.58	408	985 310.59	4 445 881.99			
349	985 301.09	4 445 173.57	409	985 281.46	4 445 921.08			
350	985 297.19	4 445 173.67	410	985 285.47	4 445 920.99			
351	985 316.2	4 445 233.58	411	985 285.4	4 445 917.98			
352	985 320.21	4 445 233.42	412	985 281.39	4 445 918.14			
353	985 320.15	4 445 230.42	413	985 250.67	4 445 958.71			
354	985 316.13	4 445 230.57	414	985 256.58	4 445 958.53			

Перечень координат поворотных точек земельного участка № 04-0060001-117039-3У1

Номер	X	Y
1	954 895.07	4 420 376.09
2	954 893.27	4 420 372.64
3	954 901.75	4 420 276.19
4	954 903.9	4 420 275.85
5	954 888.84	4 420 446.71
6	954 885.93	4 420 444.83
7	954 889.41	4 420 416.62
8	954 892.67	4 420 403.33

Перечень координат поворотных точек земельного участка № 04-0060001-103576-3У1

Номер	X	Y
1	984 347.04	4 443 255.6
2	984 317.7	4 443 250.09
3	984 342.31	4 443 247.98
4	984 344.37	4 443 251.18
5	985 141.73	4 446 045
6	985 157.35	4 446 031.74
7	985 176.28	4 446 025.64
8	985 159.18	4 446 039.5

Перечень координат поворотных точек земельного участка № 04-0060001-109667-3У1

Номер	X	Y
1	957 343.84	4 412 918.23
2	957 344.22	4 412 925.81
3	957 341.21	4 412 925.67
4	957 340.85	4 412 918.38
5	957 340.95	4 412 928.17
6	957 343.97	4 412 928.42
7	957 342.51	4 412 935.42
8	957 339.58	4 412 934.81
9	957 315.05	4 413 068.19
10	957 315.39	4 413 068.51
11	957 312.7	4 413 064.72
12	957 313.95	4 413 058.64
13	957 316.89	4 413 059.25
14	957 311.34	4 413 068.94
15	957 313.94	4 413 068.68
16	957 315.05	4 413 068.19
17	957 307.24	4 413 072.97
18	957 305.67	4 413 070.42
19	957 307.78	4 412 551.49
20	957 310.4	4 412 549.02
21	957 311.74	4 412 556.94
22	957 308.78	4 412 557.45
23	957 301.01	4 412 545.2
24	957 308.84	4 412 547.25
25	957 308.21	4 412 549.68
26	957 300.25	4 412 548.1

Перечень координат поворотных точек земельного участка 86-04-0000001-24347-3/1

Номер	X	Y
1	983 696.46	4 443 367.26
2	983 696.22	4 443 370.42
3	983 689.44	4 443 372.4
4	983 689.63	4 443 368.9
5	983 683.6	4 443 369.99
6	983 683.4	4 443 373.5
7	983 671.35	4 443 375.38
8	983 671.53	4 443 372.2

Перечень координат поворотных точек земельного участка 86-04-0000001-22138-3/1

Номер	X	Y
1	984 520.06	4 443 458.23
2	984 519.59	4 443 459.8
3	984 517.52	4 443 459.1
4	984 517.8	4 443 457.65
5	984 501.3	4 443 511.94
6	984 503.45	4 443 513.32
7	984 501.84	4 443 517.29
8	984 499.94	4 443 515.39
9	984 498.81	4 443 452.07
10	984 503.12	4 443 458.74
11	984 505.31	4 443 458.57
12	984 503.86	4 443 463.51
13	984 500.46	4 443 461.11
14	984 497.57	4 443 456.63
15	984 498.66	4 443 452.93

Перечень координат поворотных точек земельного участка 86-04-0000001-10466-1/1

Номер	X	Y
1	983 695.31	4 443 382.82
2	983 695.17	4 443 384.63
3	983 690.55	4 443 385.73
4	983 690.25	4 443 383.75
5	983 693.26	4 443 383.3

Перечень координат поворотных точек земельного участка 86-04-0000001-109670-3/2

Номер	X	Y	Номер	X	Y
1	980 696.39	4 444 898.77	59	980 380.76	4 446 098.21
2	980 698.29	4 444 899.16	60	980 383.15	4 446 102.99
3	980 697.8	4 444 901.32	61	980 317.77	4 446 138.66
4	980 695.87	4 444 900.96	62	980 318.11	4 446 137.12
5	980 691.49	4 444 929.7	63	980 317.61	4 446 135.5
6	980 691.01	4 444 931.86	64	980 319.3	4 446 137.08
7	980 688.69	4 444 931.35	65	980 408.73	4 446 156.9
8	980 689.17	4 444 929.22	66	980 407.01	4 446 156.02
9	980 673.22	4 445 008.75	67	980 408.1	4 446 154.04
10	980 671.02	4 445 008.27	68	980 409.87	4 446 154.93
11	980 671.5	4 445 006.12	69	980 266.51	4 446 196.31
12	980 673.74	4 445 006.63	70	980 264.86	4 446 194.78
13	980 640.46	4 445 155.74	71	980 268.36	4 446 193.16
14	980 638.25	4 445 155.25	72	980 268.04	4 446 194.74
15	980 638.73	4 445 153.08	73	980 215.21	4 446 250.82
16	980 640.98	4 445 153.8	74	980 216.89	4 446 252.4
17	980 624.86	4 445 225.92	75	980 215.36	4 446 253.98
18	980 622.65	4 445 225.42	76	980 213.71	4 446 252.42
19	980 623.13	4 445 223.27	77	980 164.11	4 446 311.52
20	980 625.39	4 445 223.77	78	980 162.46	4 446 309.98
21	980 609.15	4 445 296.09	79	980 163.97	4 446 308.37
22	980 606.95	4 445 295.6	80	980 165.65	4 446 308.96
23	980 607.43	4 445 293.44	81	980 062.38	4 446 426.14
24	980 609.88	4 445 293.96	82	980 060.73	4 446 424.6
25	980 593.45	4 445 366.06	83	980 062.23	4 446 422.98
26	980 591.25	4 445 385.56	84	980 063.91	4 446 424.55
27	980 591.73	4 445 363.41	85	980 012.2	4 446 483.21
28	980 593.98	4 445 363.92	86	980 010.55	4 446 481.67
29	980 576.72	4 445 431.39	87	980 012.04	4 446 480.06
30	980 578.86	4 445 431.9	88	980 013.73	4 446 481.64
31	980 578.41	4 445 433.78	89	979 961.92	4 446 540.09
32	980 575	4 445 433.88	90	979 960.27	4 446 538.55
33	980 575.07	4 445 436.88	91	979 961.77	4 446 536.93
34	980 577.89	4 445 436.8	92	979 963.45	4 446 538.51
35	980 577.74	4 445 437.97	93	979 911.32	4 446 597.04
36	980 575.56	4 445 437.68	94	979 909.67	4 446 595.5
37	980 566.85	4 445 499.45	95	979 911.18	4 446 593.88
38	980 567.95	4 445 489.61	96	979 912.86	4 446 595.45
39	980 567.67	4 445 501.55	97	979 861.15	4 446 653.91
40	980 566.57	4 445 501.41	98	979 859.51	4 446 652.37
41	980 535.32	4 445 747.01	99	979 861.01	4 446 650.76
42	980 532.35	4 445 746.59	100	979 862.68	4 446 652.33
43	980 534.69	4 445 729.72	101	979 810.67	4 446 710.76
44	980 537.67	4 445 730.11	102	979 809.02	4 446 709.23
45	980 472.75	4 445 964.09	103	979 810.53	4 446 707.6
46	980 469.61	4 445 964.18	104	979 812.2	4 446 709.19
47	980 469.53	4 445 964.13	105	979 760.36	4 446 764.58
48	980 470.77	4 445 962.71	106	979 762.02	4 446 766.16
49	980 420.23	4 446 020.31	107	979 760.48	4 446 767.73
50	980 421.91	4 446 021.88	108	979 758.84	4 446 766.19
51	980 420.37	4 446 023.46	109	979 710.1	4 446 824.7
52	980 418.73	4 446 021.92	110	979 708.45	4 446 823.15
53	980 370.3	4 446 076.4	111	979 709.96	4 446 821.55
54	980 373.47	4 446 079.64	112	979 711.64	4 446 823.12
55	980 369.24	4 446 084.16	113	979 660.09	4 446 879.59
56	980 366.14	4 446 081.09	114	979 660.17	4 446 880.88
57	980 380.61	4 446 104.41	115	979 659.42	4 446 881.65

Номер	X	Y	Номер	X	Y	Номер	X	Y
118	978 609.33	4 446 938.62	178	978 924.95	4 447 713.5	238	978 219.74	4 448 501.98
119	979 607.68	4 446 937.08	179	978 922.78	4 447 711.43	239	978 165.91	4 448 557.99
120	979 609.18	4 446 935.48	180	978 889.05	4 447 753.37	240	978 167.59	4 448 559.56
121	979 610.87	4 446 937.06	181	978 087.46	4 447 755.15	241	978 168.06	4 448 561.13
122	979 558.95	4 446 995.59	182	978 885.26	4 447 753.1	242	978 164.42	4 448 559.59
123	979 557.3	4 446 994.05	183	978 888.87	4 447 751.3	243	978 113.48	4 448 616.1
124	979 558.8	4 446 992.43	184	978 782.78	4 447 866.73	244	978 115.17	4 448 617.68
125	979 560.48	4 446 994.02	185	978 781.13	4 447 867.19	245	978 113.64	4 448 619.25
126	979 505.72	4 447 051.79	188	978 782.63	4 447 865.58	246	978 111.99	4 448 617.72
127	979 509.46	4 447 051.68	187	978 784.32	4 447 867.16	247	978 060.74	4 448 674.52
128	979 507.12	4 447 054.32	189	979 730.18	4 447 922.24	248	978 052.42	4 448 676.1
129	979 505.48	4 447 052.86	189	978 731.86	4 447 923.81	249	978 061.09	4 448 677.46
130	979 505.38	4 447 051.8	190	978 730.32	4 447 925.39	250	978 060.66	4 448 677.47
131	979 458.67	4 447 110.06	191	978 728.87	4 447 923.84	251	978 059.23	4 448 676.13
132	979 457.02	4 447 108.52	192	978 676.85	4 447 983.7	252	978 009.4	4 448 735.84
133	979 458.53	4 447 106.91	193	978 675.72	4 447 982.81	253	978 007.75	4 448 734.3
134	979 460.21	4 447 108.49	194	978 675.72	4 447 982.62	254	978 008.26	4 448 732.68
135	979 408.49	4 447 167.25	195	978 675.71	4 447 982.61	255	978 010.93	4 448 734.26
136	979 408.84	4 447 165.71	196	978 679.85	4 447 977.96	256	977 957.49	4 448 794.2
137	979 408.34	4 447 164.09	197	978 681.01	4 447 978.97	257	977 955.84	4 448 792.66
138	979 410.02	4 447 165.67	198	978 627.03	4 448 039.64	258	977 957.34	4 448 791.04
139	979 358.61	4 447 224.65	199	978 626	4 448 038.67	259	977 959.02	4 448 792.62
140	979 356.96	4 447 223.12	200	978 627.47	4 448 037.02	260	977 905.66	4 448 853.09
141	979 358.46	4 447 221.49	201	978 628.56	4 448 038.04	261	977 904.01	4 448 851.54
142	979 360.15	4 447 223.08	202	978 574.82	4 448 096.39	262	977 905.51	4 448 849.82
143	979 308.43	4 447 281.73	203	978 576.28	4 448 094.75	263	977 907.2	4 448 851.49
144	979 306.78	4 447 280.19	204	978 577.42	4 448 095.81	264	977 853.85	4 448 911.53
145	979 308.28	4 447 278.57	205	978 575.88	4 448 097.38	265	977 852.2	4 448 910
146	979 309.97	4 447 280.15	206	978 523.75	4 448 154	266	977 853.7	4 448 908.39
147	979 258.66	4 447 339.04	207	978 525.21	4 448 152.35	267	977 855.38	4 448 909.86
148	979 257	4 447 337.49	208	978 526.17	4 448 153.25	268	977 802.04	4 448 970
149	979 256.51	4 447 335.89	209	978 524.63	4 448 154.82	269	977 800.39	4 448 968.46
150	979 260.19	4 447 337.46	210	978 471.17	4 448 213.3	270	977 801.89	4 448 966.84
151	979 216.72	4 447 384.81	211	978 475.28	4 448 208.66	271	977 803.57	4 448 968.43
152	979 215.07	4 447 383.36	212	978 476.39	4 448 209.62	272	977 750.12	4 449 028.57
153	979 216.58	4 447 381.76	213	978 472.26	4 448 214.29	273	977 748.47	4 449 027.02
154	979 218.25	4 447 383.33	214	978 422.97	4 448 267.68	274	977 749.96	4 449 025.41
155	979 174.42	4 447 427.93	215	978 424.27	4 448 268.9	275	977 751.65	4 449 026.99
156	979 176.1	4 447 429.51	216	978 422.74	4 448 270.48	276	977 698.16	4 449 087.87
157	979 174.56	4 447 431.08	217	978 421.5	4 448 269.31	277	977 697.84	4 449 087.78
158	979 172.91	4 447 429.54	218	978 371.99	4 448 328.69	278	977 697.84	4 449 087.75
159	979 132.08	4 447 473.65	219	978 370.34	4 448 327.13	279	977 697.57	4 449 084.73
160	979 134.26	4 447 475.73	220	978 371.84	4 448 325.53	280	977 697.76	4 449 084.44
161	979 133.84	4 447 476.2	221	978 373.52	4 448 327.1	281	977 696.83	4 449 086.18
162	979 131.38	4 447 478.27	222	978 321.14	4 448 386.66	282	977 648.92	4 449 143.2
163	979 130.46	4 447 475.47	223	978 319.49	4 448 385.13	283	977 648.61	4 449 144.78
164	979 081.2	4 447 536.36	224	978 320.99	4 448 383.5	284	977 647.08	4 449 146.36
165	979 079.55	4 447 534.84	225	978 322.68	4 448 385.08	285	977 645.43	4 449 144.82
166	979 081.05	4 447 533.22	226	978 271.43	4 448 439.9	286	977 546.58	4 449 264.2
167	979 082.74	4 447 534.8	227	978 272.8	4 448 441.12	287	977 545.05	4 449 265.98
168	979 028.86	4 447 585.9	228	978 269.04	4 448 441.24	288	977 542.65	4 449 264.16
169	979 026.21	4 447 594.36	229	978 269.07	4 448 441.21	289	977 544.36	4 449 262.18
170	979 029.71	4 447 592.75	230	978 269	4 448 441.35	290	977 493.07	4 449 317.64
171	979 031.39	4 447 594.33	231	978 269.18	4 448 444.2	291	977 494.61	4 449 319.2
172	978 977.41	4 447 654.55	232	978 270.6	4 448 444.16	292	977 490.91	4 449 322.91
173	978 975.76	4 447 653.01	233	978 268.84	4 448 448.02	293	977 489.32	4 449 322.96
174	978 977.27	4 447 651.39	234	978 267.3	4 448 444.56	294	977 488.53	4 449 322.17

Перечень координат поворотных точек земельного участка
86:04:0060001:109670:3У2

Номер	X	Y	Номер	X	Y
298	977 440.14	4 449 378.06	358	975 912.92	4 449 783.98
299	977 385.6	4 449 436.89	359	975 913.07	4 449 785.29
300	977 383.95	4 449 435.36	360	975 837.15	4 449 791.47
301	977 385.45	4 449 433.74	361	975 837.34	4 449 793.78
302	977 387.13	4 449 435.31	362	975 834.19	4 449 794.06
303	977 332.47	4 449 494.57	363	975 834.12	4 449 794.05
304	977 330.82	4 449 493.02	364	975 831.05	4 449 794.2
305	977 332.32	4 449 491.41	365	975 831.01	4 449 791.89
306	977 334	4 449 492.99	366	975 834.01	4 449 791.75
307	977 280.84	4 449 547.39	367	975 754.64	4 449 796.09
308	977 282.39	4 449 548.9	368	975 754.49	4 449 793.83
309	977 278.41	4 449 549.03	369	975 756.69	4 449 793.68
310	977 278.48	4 449 552.04	370	975 756.84	4 449 795.99
311	977 279.32	4 449 552.01			
312	977 277.78	4 449 553.43			
313	977 276.26	4 449 551.82			
314	977 278.39	4 449 549.01			
315	977 218.45	4 449 608.15			
316	977 218.53	4 449 608.1			
317	977 217.78	4 449 606.45			
318	977 150.15	4 449 644.11			
319	977 149.43	4 449 641.94			
320	977 151.53	4 449 641.24			
321	977 152.28	4 449 643.44			
322	977 069.32	4 449 663.88			
323	977 069.71	4 449 666.05			
324	977 068.87	4 449 666.28			
325	977 068.25	4 449 663.94			
326	977 004.04	4 449 670.95			
327	977 004.15	4 449 671.98			
328	976 997.8	4 449 672.64			
329	976 997.66	4 449 671.69			
330	976 924.29	4 449 678.7			
331	976 924.38	4 449 680.31			
332	976 922.16	4 449 680.52			
333	976 922.1	4 449 680.03			
334	976 224.09	4 449 753.98			
335	976 221.89	4 449 754.23			
336	976 221.81	4 449 753.02			
337	976 224.01	4 449 752.88			
338	976 142.3	4 449 763.17			
339	976 142.08	4 449 760.35			
340	976 148.26	4 449 759.76			
341	976 148.52	4 449 782.48			
342	976 066.28	4 449 770.57			
343	976 066.12	4 449 768.33			
344	976 068.32	4 449 768.15			
345	976 068.48	4 449 770.46			
346	975 994.15	4 449 776.81			
347	975 990.13	4 449 777.28			
348	975 990.27	4 449 778.36			
349	975 988.6	4 449 778.81			
350	975 988.28	4 449 778.76			
351	975 993.95	4 449 775.66			
352	975 743.47	4 449 786.58			
353	975 741.86	4 449 785.07			
354	975 743.39	4 449 783.4			

Перечень координат поворотных точек земельного участка 86:04:0060001:109671:3У2

Номер	X	Y	Номер	X	Y
45	955 039	4 435 647.99	1	954 903.2	4 434 826.29
46	955 039.65	4 435 649.99	2	954 905.52	4 434 826.35
47	955 061.97	4 435 729.99	3	954 905.68	4 434 828.14
48	955 061.32	4 435 727.88	4	954 903.39	4 434 828.35
49	955 063.51	4 435 727.21	5	954 912.87	4 434 908.66
50	955 064.16	4 435 729.31	6	954 913.06	4 434 912.05
51	955 086.46	4 435 809.31	7	954 910.78	4 434 912.24
52	955 085.81	4 435 807.21	8	954 910.58	4 434 910.05
53	955 088	4 435 808.52	9	954 918.16	4 434 996.11
54	955 088.66	4 435 808.63	10	954 917.97	4 434 993.91
55	955 110.86	4 435 888.63	11	954 920.25	4 434 993.71
56	955 110.32	4 435 886.53	12	954 920.45	4 434 995.91
57	955 112.52	4 435 885.85	13	954 925.54	4 435 078.96
58	955 113.17	4 435 887.94	14	954 925.34	4 435 077.77
59	955 135.48	4 435 967.95	15	954 927.64	4 435 077.58
60	955 134.83	4 435 965.85	16	954 927.83	4 435 079.77
61	955 137.02	4 435 965.17	17	954 932.92	4 435 163.82
62	955 137.67	4 435 967.27	18	954 932.73	4 435 161.63
63	955 161.41	4 436 042.87	19	954 935.01	4 435 161.43
64	955 161.82	4 436 044.48	20	954 935.21	4 435 163.63
65	955 163.9	4 436 044.75	21	954 940.3	4 435 247.67
66	955 161.2	4 436 047.28	22	954 940.1	4 435 245.47
67	955 159.96	4 436 047.1	23	954 942.4	4 435 245.28
68	955 159.12	4 436 044.72	24	954 942.59	4 435 247.47
69	955 239.35	4 436 055.79	25	954 949.77	4 435 329.16
70	955 241.52	4 436 056.11	26	954 949.97	4 435 331.34
71	955 241.2	4 436 058.38	27	954 947.68	4 435 331.53
72	955 239.02	4 436 058.07	28	954 947.49	4 435 329.34
73	955 320.92	4 436 069.63	29	954 957.48	4 435 412.56
74	955 318.75	4 436 069.32	30	954 957.6	4 435 413.89
75	955 319.06	4 436 067.04	31	954 957.99	4 435 415
76	955 321.25	4 436 067.34	32	954 955.04	4 435 415.67
77	955 400.56	4 436 080.85	33	954 954.7	4 435 414.72
78	955 398.38	4 436 080.54	34	954 954.53	4 435 412.89
79	955 398.71	4 436 078.26	35	954 983.45	4 435 493.76
80	955 400.89	4 436 078.58	36	954 982.72	4 435 491.7
81	955 480.18	4 436 092.08	37	954 984.88	4 435 490.93
82	955 478	4 436 091.77	38	954 985.62	4 435 492.99
83	955 478.32	4 436 089.49	39	955 011.51	4 435 571.89
84	955 480.5	4 436 089.8	40	955 010.76	4 435 569.82
85	955 559.81	4 436 103.31	41	955 012.93	4 435 569.04
86	955 557.64	4 436 103.01	42	955 013.66	4 435 571.12

Номер	X	Y	Номер	X	Y	Номер	X	Y
88	955 639.44	4 436 114.55	149	956 404.01	4 436 389.76	209	957 165.64	4 437 051.53
90	955 637.26	4 436 114.23	150	956 419.77	4 436 465.19	210	957 226.92	4 437 091.09
91	955 637.58	4 436 111.96	151	956 419.32	4 436 463.04	211	957 225.03	4 437 089.98
92	955 639.78	4 436 112.27	152	956 421.58	4 436 462.57	212	957 226.21	4 437 087.99
93	955 719.06	4 436 125.77	153	956 422.02	4 436 464.73	213	957 228.1	4 437 089.11
94	955 716.89	4 436 125.47	154	956 430.16	4 436 514.92	214	957 307.66	4 437 135.77
95	955 717.21	4 436 123.19	155	956 429.71	4 436 512.78	215	957 310.45	4 437 137.57
96	955 719.39	4 436 123.5	156	956 431.96	4 436 512.29	216	957 310.28	4 437 137.83
97	955 796.83	4 436 134.41	157	956 432.41	4 436 514.44	217	957 308.82	4 437 140.1
98	955 799.01	4 436 134.73	158	956 445.5	4 436 577.1	218	957 307.56	4 437 139.27
99	955 798.68	4 436 137	159	956 445.8	4 436 578.53	219	957 360.25	4 437 170.75
100	955 796.5	4 436 136.69	160	956 443.27	4 436 577.66	220	957 362.09	4 437 171.95
101	955 878.31	4 436 148.23	161	956 443.25	4 436 577.56	221	957 360.84	4 437 173.87
102	955 876.13	4 436 147.91	162	956 455.95	4 436 636.32	222	957 359.01	4 437 172.66
103	955 876.46	4 436 145.64	163	956 455.5	4 436 636.16	223	957 418.59	4 437 211.84
104	955 878.64	4 436 145.95	164	956 457.76	4 436 635.69	224	957 416.76	4 437 210.63
105	955 955.74	4 436 156.48	165	956 458.2	4 436 637.85	225	957 418.03	4 437 208.7
106	955 957.31	4 436 156.71	166	956 506.58	4 436 816.81	226	957 419.66	4 437 209.93
107	955 959.02	4 436 157.26	167	956 506.96	4 436 817.93	227	957 474.38	4 437 245.75
108	955 958.35	4 436 160.17	168	956 508.59	4 436 818.25	228	957 473.11	4 437 247.67
109	955 956.71	4 436 159.64	169	956 505.75	4 436 820.89	229	957 471.28	4 437 246.46
110	955 955.17	4 436 159.43	170	956 504.77	4 436 820.49	230	957 472.55	4 437 244.54
111	956 032.02	4 436 181.58	171	956 504.12	4 436 818.83	231	957 535.34	4 437 285.82
112	956 034.1	4 436 182.28	172	956 587.95	4 436 833.99	232	957 534.06	4 437 287.72
113	956 033.74	4 436 183.4	173	956 590.11	4 436 834.39	233	957 532.23	4 437 286.51
114	956 031.62	4 436 182.81	174	956 589.87	4 436 836.60	234	957 533.5	4 437 284.6
115	956 112.42	4 436 203.28	175	956 587.51	4 436 836.24	235	957 615.57	4 437 415.58
116	956 111.99	4 436 205.53	176	956 671.77	4 436 852.45	236	957 615.04	4 437 413.44
117	956 110.57	4 436 205.33	177	956 669.61	4 436 852.05	237	957 617.27	4 437 412.89
118	956 110.92	4 436 203.06	178	956 670.04	4 436 849.79	238	957 617.8	4 437 415.03
119	956 185.03	4 436 217.22	179	956 672.2	4 436 850.21	239	957 635.41	4 437 506.1
120	956 186.88	4 436 217.93	180	956 753.2	4 436 868.13	240	957 633.81	4 437 499.9
121	956 185.7	4 436 220.67	181	956 751.04	4 436 867.72	241	957 636.11	4 437 499.26
122	956 184.23	4 436 220.1	182	956 751.48	4 436 865.46	242	957 638.24	4 437 498.71
123	956 182.43	4 436 219.76	183	956 753.63	4 436 865.87	243	957 639.94	4 437 504.74
124	956 183.53	4 436 216.93	184	956 835.08	4 436 883.9	244	957 637.84	4 437 505.39
125	956 259.64	4 436 248.93	185	956 832.92	4 436 883.48	245	957 581.75	4 437 498.96
126	956 257.58	4 436 248.15	186	956 833.36	4 436 881.22	246	957 582.74	4 437 498.99
127	956 258.41	4 436 246.01	187	956 835.52	4 436 881.64	247	957 583.16	4 437 501.99
128	956 260.46	4 436 246.79	188	956 915.23	4 436 896.68	248	957 581.83	4 437 501.96
129	956 073.06	4 436 266.85	189	956 916.67	4 436 896.96	249	957 580.8	4 437 502.16
130	956 070.88	4 436 266.53	190	956 918.08	4 436 897.83	250	957 580.49	4 437 499.19
131	956 071.23	4 436 264.26	191	956 916.5	4 436 900.43	251	957 658.96	4 437 572.46
132	956 073.4	4 436 264.58	192	956 915.18	4 436 899.62	252	957 658.31	4 437 570.36
133	956 335.27	4 436 278.97	193	956 913.7	4 436 899.35	253	957 660.49	4 437 569.67
134	956 332.97	4 436 277.29	194	956 978.25	4 436 938.24	254	957 661.15	4 437 571.77
135	956 330	4 436 276.13	195	956 976.37	4 436 937.08	255	957 682.91	4 437 640.68
136	956 330.81	4 436 274.09	196	956 977.58	4 436 935.13	256	957 680.72	4 437 641.36
137	956 333.97	4 436 275.31	197	956 979.46	4 436 936.29	257	957 680.06	4 437 639.27
138	956 336.52	4 436 277.16	198	957 040.29	4 436 976.64	258	957 682.26	4 437 638.57
139	956 390.28	4 436 315.74	199	957 038.41	4 436 975.48	259	957 704.3	4 437 708.67
140	956 391.36	4 436 316.58	200	957 039.63	4 436 973.54	260	957 704.84	4 437 711.72
141	956 391.62	4 436 317.79	201	957 041.5	4 436 974.7	261	957 702.67	4 437 712.11
142	956 388.97	4 436 319.51	202	957 103.55	4 437 013.1	262	957 702.18	4 437 709.24
143	956 388.77	4 436 318.58	203	957 102.34	4 437 015.04	263	957 701.26	4 437 706.34
144	956 388.69	4 436 318.18	204	957 100.46	4 437 013.88	264	957 703.38	4 437 705.67
145	956 387.78	4 436 317.51	205	957 101.67	4 437 011.93	265	957 720.55	4 437 795.67

Перечень координат поворотных точек земельного участка
86.04.000001.109671.3У2

Номер	X	Y	Номер	X	Y
269	957 735.08	4 437 886.37	329	958 100.19	4 438 741.77
270	957 734.68	4 437 884.21	330	958 102.43	4 438 741.22
271	957 736.95	4 437 883.8	331	958 102.93	4 438 743.37
272	957 737.35	4 437 885.95	332	958 118.25	4 438 817.88
273	957 751.48	4 437 974.49	333	958 117.73	4 438 815.75
274	957 751.08	4 437 972.32	334	958 119.97	4 438 815.21
275	957 753.33	4 437 971.91	335	958 120.48	4 438 817.36
276	957 753.74	4 437 974.06	336	958 135.8	4 438 881.86
277	957 769.72	4 438 060.02	337	958 135.29	4 438 889.73
278	957 770.12	4 438 062.18	338	958 137.52	4 438 889.19
279	957 767.87	4 438 062.6	339	958 138.04	4 438 891.34
280	957 767.46	4 438 060.43	340	958 155.41	4 438 963.15
281	957 786.35	4 438 147.49	341	958 155.73	4 438 964.54
282	957 786.59	4 438 148.76	342	958 155.68	4 438 965.71
283	957 787.27	4 438 149.58	343	958 152.66	4 438 966.02
284	957 784.57	4 438 150.98	344	958 152.72	4 438 964.78
285	957 783.86	4 438 150.11	345	958 152.41	4 438 963.43
286	957 783.57	4 438 148.62	346	958 151.43	4 439 050.54
287	957 810.66	4 438 178.08	347	958 149.13	4 439 050.43
288	957 811.44	4 438 178.99	348	958 149.23	4 439 048.24
289	957 812.76	4 438 179.34	349	958 151.53	4 439 048.34
290	957 811.32	4 438 182	350	958 147.52	4 439 135.72
291	957 810.67	4 438 181.82	351	958 145.23	4 439 135.61
292	957 809.78	4 438 181.58	352	958 145.33	4 439 133.41
293	957 808.99	4 438 180.64	353	958 147.62	4 439 133.52
294	957 895.39	4 438 203.91	354	958 141.43	4 439 218.44
295	957 893.27	4 438 203.35	355	958 143.72	4 439 218.55
296	957 893.85	4 438 201.12	356	958 143.63	4 439 220.79
297	957 895.99	4 438 201.69	357	958 141.33	4 439 220.64
298	957 977.99	4 438 223	358	957 884.06	4 439 289.59
299	957 979.86	4 438 223.51	359	957 885.75	4 439 290.36
300	957 980.34	4 438 225.48	360	957 886.84	4 439 290.42
301	957 977.71	4 438 227.13	361	957 886.59	4 439 293.41
302	957 977.42	4 438 225.92	362	957 885.14	4 439 293.34
303	957 975.63	4 438 226.44	363	957 883.23	4 439 292.48
304	957 997.08	4 438 297.36	364	957 970.73	4 439 297.3
305	957 997.6	4 438 299.5	365	957 968.53	4 439 297.19
306	957 995.36	4 438 300.03	366	957 968.65	4 439 294.89
307	957 994.86	4 438 297.86	367	957 970.85	4 439 295.01
308	958 012.92	4 438 374	368	958 055.2	4 439 301.56
309	958 012.41	4 438 371.86	369	958 053	4 439 301.45
310	958 014.65	4 438 371.33	370	958 053.13	4 439 299.15
311	958 015.15	4 438 373.47	371	958 055.32	4 439 299.26
312	958 030.47	4 438 447.98	372	958 140.07	4 439 306.08
313	958 029.96	4 438 445.84	373	958 137.2	4 439 305.96
314	958 032.19	4 438 445.3	374	958 137.2	4 438 303
315	958 032.69	4 438 447.45			
316	958 048.9	4 438 525.64			
317	958 048.39	4 438 523.51			
318	958 050.83	4 438 522.97			
319	958 051.14	4 438 525.12			
320	958 066.44	4 438 599.53			
321	958 065.93	4 438 597.39			
322	958 068.16	4 438 598.86			
323	958 068.67	4 438 599			
324	958 083.14	4 438 669.92			
325	958 082.63	4 438 667.79			

Перечень координат поворотных точек земельного участка 86.04.000001.110006.3У2

Номер	X	Y
1	954 255.89	4 430 832.82
2	954 258.19	4 430 832.81
3	954 258.17	4 430 830.61
4	954 255.88	4 430 830.62
5	954 258.67	4 430 916.19
6	954 258.66	4 430 913.97
7	954 256.37	4 430 913.99
8	954 256.38	4 430 916.19
9	954 256.87	4 430 999.55
10	954 259.16	4 430 999.54
11	954 259.16	4 430 997.33
12	954 256.85	4 430 997.35
13	954 257.36	4 431 082.92
14	954 259.65	4 431 082.91
15	954 259.65	4 431 080.71
16	954 257.34	4 431 080.73
17	954 190.99	4 431 164.41
18	954 190.99	4 431 163.9
19	954 188.74	4 431 163.93
20	954 188.74	4 431 164.19
21	954 188.76	4 431 166.19
22	954 190.99	4 431 166.18
23	954 190.99	4 431 165.41
24	954 188.75	4 431 165.21
25	954 260.06	4 431 168.26
26	954 260.3	4 431 161.97
27	954 255.86	4 431 161.81
28	954 255.57	4 431 168.05
29	954 174.23	4 431 175.16
30	954 177.73	4 431 173.19
31	954 176.32	4 431 170.54
32	954 172.72	4 431 172.49
33	954 260.55	4 431 251.53
34	954 260.56	4 431 245.46
35	954 258.35	4 431 245.41
36	954 258.35	4 431 251.49
37	954 258.48	4 431 333.01
38	954 259.52	4 431 330.8
39	954 257.22	4 431 330.78
40	954 257.18	4 431 332.96
41	954 257.82	4 431 416.35
42	954 257.86	4 431 414.15
43	954 255.56	4 431 414.1
44	954 255.52	4 431 416.3
45	954 256.15	4 431 489.67
46	954 256.19	4 431 487.47
47	954 253.89	4 431 487.42
48	954 253.84	4 431 489.62
49	954 254.47	4 431 582.99
50	954 254.51	4 431 580.79
51	954 252.22	4 431 580.75
52	954 252.18	4 431 582.94
53	954 252.81	4 431 666.38
54	954 252.85	4 431 664.18
55	954 250.55	4 431 664.13
56	954 250.51	4 431 666.33
57	954 251.15	4 431 749.73

Номер	X	Y	Номер	X	Y	Номер	X	Y
60	954 248.85	4 431 749.68	120	954 432.35	4 432 939.27	180	954 755.76	4 433 952.56
61	954 249.48	4 431 833.08	121	954 468.52	4 433 021.9	181	954 753.62	4 433 951.69
62	954 249.52	4 431 830.88	122	954 470.83	4 433 020.97	182	954 752.8	4 433 953.73
63	954 247.22	4 431 830.84	123	954 469.74	4 433 018.95	183	954 730.49	4 434 015.97
64	954 247.18	4 431 833.04	124	954 467.83	4 433 019.88	184	954 731.71	4 434 013.43
65	954 247.82	4 431 916.41	125	954 503.82	4 433 102.5	185	954 729.11	4 434 012.17
66	954 247.86	4 431 914.22	126	954 505.92	4 433 101.58	186	954 728.16	4 434 014.68
67	954 245.56	4 431 914.17	127	954 505.03	4 433 099.56	187	954 844.34	4 434 157.51
68	954 245.52	4 431 916.37	128	954 502.93	4 433 100.48	188	954 846.63	4 434 157.31
69	954 246.15	4 431 999.76	129	954 539.1	4 433 183.11	189	954 846.43	4 434 155.13
70	954 246.19	4 431 997.56	130	954 541.21	4 433 182.19	190	954 844.15	4 434 155.32
71	954 243.89	4 431 997.52	131	954 540.32	4 433 180.17	191	954 851.72	4 434 241.37
72	954 243.85	4 431 999.71	132	954 538.21	4 433 181.09	192	954 854.01	4 434 241.18
73	954 244.49	4 432 083.11	133	954 574.39	4 433 283.72	193	954 853.82	4 434 239
74	954 244.53	4 432 080.91	134	954 576.49	4 433 282.81	194	954 851.53	4 434 239.19
75	954 242.23	4 432 080.86	135	954 575.6	4 433 280.79	195	954 858.95	4 434 326.99
76	954 242.19	4 432 083.06	136	954 573.5	4 433 281.7	196	954 861.95	4 434 326.78
77	954 242.83	4 432 166.45	137	954 610.5	4 433 346.11	197	954 861.36	4 434 320.02
78	954 242.87	4 432 164.26	138	954 612.51	4 433 345.24	198	954 858.38	4 434 320.33
79	954 240.57	4 432 164.21	139	954 610.05	4 433 339.57	199	954 866.27	4 434 410.36
80	954 240.53	4 432 166.41	140	954 608.03	4 433 340.43	200	954 869.25	4 434 410.09
81	954 241.16	4 432 249.8	141	954 642.27	4 433 426.09	201	954 868.67	4 434 403.38
82	954 241.2	4 432 247.59	142	954 644.41	4 433 425.27	202	954 865.68	4 434 403.59
83	954 238.9	4 432 247.55	143	954 643.62	4 433 423.21	203	954 873.87	4 434 492.94
84	954 238.86	4 432 249.75	144	954 641.47	4 433 424.02	204	954 876.18	4 434 492.76
85	954 239.5	4 432 333.15	145	954 672	4 433 511.18	205	954 875.96	4 434 490.55
86	954 239.54	4 432 330.95	146	954 676.81	4 433 509.61	206	954 873.68	4 434 490.76
87	954 237.24	4 432 330.9	147	954 674.65	4 433 503.93	207	954 881.25	4 434 576.81
88	954 237.2	4 432 333.1	148	954 670.07	4 433 505.4	208	954 883.53	4 434 576.61
89	954 235.55	4 432 416.91	149	954 627	4 433 540.17	209	954 883.35	4 434 574.42
90	954 238.49	4 432 416.47	150	954 628.39	4 433 539.89	210	954 881.05	4 434 574.63
91	954 238.2	4 432 415.21	151	954 629.44	4 433 539.18	211	954 886.98	4 434 664.68
92	954 238.21	4 432 414.27	152	954 628.22	4 433 536.4	212	954 891.27	4 434 664.49
93	954 235.22	4 432 414.54	153	954 627.28	4 433 537.03	213	954 891.08	4 434 662.29
94	954 235.21	4 432 415.39	154	954 626.04	4 433 537.29	214	954 888.79	4 434 662.49
95	954 253.72	4 432 494.62	155	954 697.25	4 433 569.14	215	954 896.01	4 434 744.44
96	954 255.97	4 432 494.11	156	954 699.39	4 433 568.31	216	954 896.3	4 434 744.24
97	954 255.47	4 432 491.96	157	954 698.6	4 433 566.26	217	954 898.1	4 434 742.04
98	954 253.23	4 432 492.47	158	954 696.46	4 433 567.08	218	954 895.82	4 434 742.24
99	954 271.56	4 432 572.7	159	954 728.01	4 433 649.16			
100	954 274.35	4 432 571.08	160	954 730.16	4 433 648.33			
101	954 273.94	4 432 570.72	161	954 729.37	4 433 646.27			
102	954 273.67	4 432 569.58	162	954 727.22	4 433 647.09			
103	954 270.82	4 432 570.54	163	954 758.78	4 433 729.18			
104	954 271.06	4 432 571.54	164	954 760.91	4 433 728.37			
105	954 330.52	4 432 707.67	165	954 760.13	4 433 726.31			
106	954 333.28	4 432 706.48	166	954 757.98	4 433 727.13			
107	954 326.47	4 432 690.86	167	954 788.51	4 433 809.11			
108	954 323.73	4 432 692.07	168	954 791.54	4 433 809.04			
109	954 363.05	4 432 781.77	169	954 791.72	4 433 807.77			
110	954 365.8	4 432 780.57	170	954 791.32	4 433 806.68			
111	954 361.28	4 432 770.24	171	954 788.2	4 433 806.72			
112	954 358.52	4 432 771.44	172	954 788.67	4 433 807.95			
113	954 397.95	4 432 860.66	173	954 780.22	4 433 892.56			
114	954 400.06	4 432 859.76	174	954 780.55	4 433 891.73			
115	954 399.18	4 432 857.74	175	954 780.75	4 433 890.35			
116	954 397.07	4 432 859.65	176	954 777.84	4 433 889.65			

Перечень координат поворотных точек земельного участка
86:04:0000001:109985:3V2

Номер	X	Y	Номер	X	Y
1	954 323.73	4 432 692.07	81	957 596.35	4 437 338.6
2	954 320.3	4 432 683.86	82	957 595.82	4 437 336.46
3	954 323.07	4 432 682.67	83	957 598.05	4 437 335.91
4	954 326.47	4 432 690.86	84	957 598.58	4 437 338.04
5	954 358.52	4 432 771.44	85	957 539.17	4 437 507.24
6	954 330.52	4 432 707.67	86	957 538.9	4 437 505.06
7	954 333.28	4 432 706.48	87	957 541.17	4 437 504.78
8	954 361.28	4 432 770.24	88	957 541.45	4 437 506.95
9	954 594.59	4 433 542.72	89	957 869.41	4 439 282.94
10	954 594.37	4 433 540.53	90	957 867.55	4 439 281.77
11	954 596.66	4 433 540.31	91	957 868.78	4 439 279.82
12	954 596.87	4 433 542.5	92	957 870.63	4 439 281.01
13	954 783.65	4 434 051.65			
14	954 781.87	4 434 050.19			
15	954 783.26	4 434 048.5			
16	954 785.03	4 434 049.95			
17	954 837.83	4 434 088.52			
18	954 837.64	4 434 086.33			
19	954 839.92	4 434 086.15			
20	954 840.12	4 434 088.32			
21	954 905.52	4 434 826.35			
22	954 903.2	4 434 828.29			
23	954 903.14	4 434 825.67			
24	954 905.44	4 434 825.48			
25	956 034.11	4 436 182.28			
26	956 032.02	4 436 181.58			
27	956 032.32	4 436 180.6			
28	956 034.44	4 436 181.22			
29	956 094.81	4 436 202.43			
30	956 092.63	4 436 202.11			
31	956 092.98	4 436 199.84			
32	956 095.15	4 436 200.16			
33	956 112.42	4 436 203.28			
34	956 113.09	4 436 203.38			
35	956 112.75	4 436 205.65			
36	956 111.99	4 436 205.53			
37	956 056.63	4 436 292.67			
38	956 054.7	4 436 291.81			
39	956 055.82	4 436 289.8			
40	956 057.75	4 436 290.86			
41	956 465.58	4 436 684.4			
42	956 465.11	4 436 682.14			
43	956 467.25	4 436 681.67			
44	956 467.74	4 436 683.93			
45	956 487.42	4 436 768.45			
46	956 486.79	4 436 766.24			
47	956 488.89	4 436 765.61			
48	956 489.54	4 436 767.83			
49	957 313.78	4 437 142.87			
50	957 309.05	4 437 139.75			
51	957 310.28	4 437 137.84			
52	957 313.91	4 437 140.24			
53	957 333.11	4 437 155.6			
54	957 327.77	4 437 152.08			
55	957 327.91	4 437 149.45			
56	957 335.59	4 437 154.51			
57	957 350.25	4 437 170.75			

Перечень координат поворотных точек земельного участка
86:04:0000001:109984:3V2

Номер	X	Y
1	980 714.59	4 444 824.84
2	980 715.04	4 444 822.7
3	980 714.42	4 444 822.58
4	980 713.91	4 444 824.71
5	980 658.06	4 445 087.67
6	980 657.42	4 445 081.32
7	980 654.67	4 445 080.79
8	980 653.28	4 445 087.12
9	980 566.57	4 445 501.41
10	980 566.85	4 445 489.45
11	980 587.95	4 445 499.61
12	980 587.98	4 445 499.38
13	980 565.89	4 445 499.08
14	980 565.59	4 445 501.26
15	980 557.4	4 445 567.63
16	980 557.72	4 445 565.43
17	980 555.75	4 445 565.15
18	980 555.45	4 445 567.35
19	980 537.67	4 445 730.11
20	980 537.81	4 445 728.36
21	980 534.84	4 445 727.97
22	980 534.69	4 445 729.72
23	980 525.11	4 445 821.28
24	980 525.98	4 445 814.94
25	980 523.09	4 445 814.59
26	980 522.37	4 445 821.05
27	979 660.09	4 446 879.59
28	979 660.64	4 446 879.57
29	979 659.47	4 446 878.5
30	978 934.79	4 447 702.23
31	978 939.09	4 447 697.39
32	978 936.96	4 447 695.55
33	978 932.71	4 447 700.33
34	978 875.43	4 447 768.62
35	978 879.73	4 447 763.78
36	978 877.6	4 447 761.94
37	978 873.35	4 447 768.72
38	977 594.18	4 449 205.66
39	977 594.16	4 449 204.88
40	977 593.79	4 449 205.35
41	977 595.57	4 449 206.74
42	977 596.5	4 449 205.61
43	977 594.19	4 449 205.67
44	977 087.46	4 449 666.47
45	977 088.87	4 449 666.28
46	977 088.25	4 449 663.94
47	977 087.16	4 449 664.2
48	975 741.89	4 449 770.98
49	975 741.96	4 449 767.86
50	975 738.03	4 449 767.46

Перечень координат поворотных точек земельного участка
86:04:000001:109672:3У2

Номер	X	Y
1	959 750 29	4 449 731.83
2	959 749 23	4 449 729.76
3	959 751 12	4 449 728.74
4	959 752 18	4 449 730.78
5	959 712 87	4 449 647.44
6	959 713 93	4 449 649.47
7	959 712 05	4 449 650.53
8	959 710 98	4 449 648.46
9	959 673 33	4 449 569.15
10	959 672 27	4 449 567.09
11	959 674 16	4 449 566.06
12	959 675 22	4 449 568.1
13	959 635 61	4 449 484.64
14	959 636 68	4 449 486.66
15	959 634 79	4 449 487.73
16	959 633 71	4 449 485.66
17	959 597 16	4 449 403.31
18	959 598 23	4 449 405.36
19	959 596 35	4 449 406.4
20	959 595 27	4 449 404.34
21	959 557 78	4 449 325.24
22	959 556 71	4 449 323.18
23	959 558 59	4 449 322.15
24	959 559 57	4 449 324.2
25	959 520 09	4 449 240.78
26	959 521 16	4 449 242.82
27	959 519 27	4 449 243.88
28	959 518 21	4 449 241.81
29	959 481 65	4 449 159.36
30	959 482 71	4 449 161.4
31	959 480 82	4 449 162.45
32	959 479 76	4 449 160.39
33	959 443 14	4 449 078.04
34	959 444 21	4 449 080.09
35	959 442 32	4 449 081.14
36	959 441 25	4 449 079.07
37	959 404 58	4 448 996.79
38	959 405 66	4 448 998.82
39	959 404 95	4 448 999.21
40	959 404 86	4 448 997.52
41	959 403 13	4 448 997.57
42	959 238 16	4 448 721.2
43	959 238 88	4 448 722.1
44	959 236 87	4 448 723.57
45	959 236 19	4 448 722.63
46	959 222 05	4 448 728.22
47	959 223 01	4 448 730.2
48	959 220 23	4 448 731.6
49	959 219 14	4 448 729.68
50	959 365 99	4 448 915.36
51	959 367 06	4 448 917.39
52	959 365 16	4 448 918.44
53	959 364 1	4 448 916.37
54	959 281 78	4 448 780.28
55	959 280 35	4 448 778.42
56	959 282 03	4 448 777.08

Перечень координат поворотных точек земельного участка
86:04:000001:109984:3У1

Номер	X	Y
1	980 679 51	4 444 952.95
2	980 674 59	4 444 952.19
3	980 680 31	4 444 926.42
4	980 677 71	4 444 925.88
5	980 681 77	4 444 907.75
6	980 762 06	4 444 549.65
7	980 762 02	4 444 559.24
8	980 761 8	4 444 605.19
9	980 694 39	4 444 955.25
10	980 883 42	4 444 953.58
11	980 686 94	4 444 938.64
12	980 689 37	4 444 939.17
13	980 691 02	4 444 931.86
14	980 691 5	4 444 929.7
15	980 693 11	4 444 922.53
16	980 690 88	4 444 922
17	980 694 2	4 444 908.02
18	980 696 2	4 444 908.44
19	980 697 8	4 444 901.32
20	980 698 29	4 444 899.16
21	980 699 95	4 444 891.5
22	980 698 14	4 444 891.38
23	980 713 91	4 444 824.71
24	980 714 59	4 444 824.84
25	980 715 04	4 444 822.7
26	980 714 42	4 444 822.58
27	980 744 84	4 444 694.04
28	980 761 72	4 444 622.75
29	980 761 52	4 444 664.44
30	980 701 78	4 444 931.14
31	980 688 79	4 444 948.58
32	980 688 61	4 444 945.57
33	980 692 62	4 444 945.47
34	980 692 69	4 444 948.49
35	980 750 92	4 444 676.33
36	980 750 85	4 444 673.31
37	980 754 87	4 444 673.22
38	980 754 93	4 444 676.17
39	980 701 24	4 444 894.25
40	980 701 06	4 444 891.24
41	980 705 08	4 444 891.09
42	980 705 14	4 444 894.1
43	980 738 47	4 444 730.55
44	980 738 4	4 444 727.54
45	980 742 42	4 444 727.44
46	980 742 49	4 444 730.4
47	980 713 57	4 444 839.97
48	980 713 5	4 444 836.96
49	980 717 52	4 444 836.86
50	980 717 58	4 444 839.87
51	980 726 01	4 444 785.74
52	980 725 94	4 444 782.73

Перечень координат поворотных точек земельного участка
86:04:000001:32239:3У2

Номер	X	Y
1	980 575 07	4 445 436.88
2	980 575	4 445 433.88
3	980 578 41	4 445 433.78
4	980 577 89	4 445 436.8
5	980 471 48	4 445 965.99
6	980 469 61	4 445 964.18
7	980 472 75	4 445 964.09
8	980 473 06	4 445 964.38
9	980 113 07	4 446 369.36
10	980 112 92	4 446 369.36
11	980 111 35	4 446 367.9
12	980 112 78	4 446 366.35
13	980 112 93	4 446 366.35
14	980 114 53	4 446 367.84
15	979 660 18	4 446 880.87
16	979 660 1	4 446 879.59
17	979 660 64	4 446 879.57
18	979 661 07	4 446 879.97
19	979 505 72	4 447 051.79
20	979 508 47	4 447 048.69
21	979 509 96	4 447 048.66
22	979 511 27	4 447 049.78
23	979 509 46	4 447 051.68
24	979 133 84	4 447 476.2
25	979 132 69	4 447 477.44
26	979 131 36	4 447 476.27
27	978 834 88	4 447 812.26
28	978 833 6	4 447 811.07
29	978 833 57	4 447 809.83
30	978 835 45	4 447 809.78
31	978 836 42	4 447 810.7
32	978 269 18	4 448 444.2
33	978 269	4 448 441.28
34	978 269 04	4 448 441.24
35	978 272 8	4 448 441.12
36	978 273 24	4 448 441.36
37	978 270 6	4 448 444.16
38	977 697 57	4 449 084.73
39	977 697 64	4 449 087.75
40	977 696 25	4 449 086 08
41	977 594 18	4 449 205 67
42	977 594 18	4 449 205 66
43	977 594 18	4 449 204 88
44	977 595 13	4 449 203 61
45	977 596 96	4 449 205 05
46	977 596 5	4 449 205 61
47	977 278 48	4 449 552 04
48	977 278 41	4 449 549 03
49	977 282 38	4 449 548 8
50	977 282 46	4 449 548 99
51	977 279 32	4 449 552 01
52	977 218 73	4 449 608 54
53	977 218 53	4 449 608 1
54	977 218 45	4 449 606 15
55	977 219 79	4 449 606 54
56	977 220 77	4 449 607 65
57	975 990 27	4 449 776 36

Номер	X	Y	Номер	X	Y	Номер	X	Y
54	980 730.02	4 444 785.64	114	980 550.2	4 445 660.32	174	980 626.64	4 445 216.83
55	980 675.97	4 444 967.93	115	980 550.22	4 445 658.66	175	980 630.65	4 445 216.73
56	980 671.23	4 444 967.34	116	980 551.71	4 445 658.68	176	980 630.72	4 445 219.74
57	980 673.29	4 444 958.1	117	980 542.51	4 445 744.71	177	980 559.84	4 445 567.95
58	980 678.12	4 444 958.85	118	980 541.06	4 445 755.04	178	980 557.4	4 445 567.63
59	980 691.08	4 444 970.18	119	980 527.57	4 445 754.7	179	980 555.45	4 445 567.35
60	980 679.89	4 444 968.54	120	980 528.67	4 445 748.15	180	980 555.75	4 445 565.15
61	980 682.04	4 444 959.44	121	980 572.63	4 445 421.7	181	980 557.72	4 445 565.43
62	980 693.08	4 444 961.13	122	980 648.98	4 445 099.1	182	980 560	4 445 565.77
63	980 672.43	4 444 982.92	123	980 664.67	4 445 101.16	183	980 624.86	4 445 225.92
64	980 667.93	4 444 982.23	124	980 667.93	4 445 101.6	184	980 622.65	4 445 225.42
65	980 668.19	4 444 981.06	125	980 646.38	4 445 193.98	185	980 623.13	4 445 223.27
66	980 672.73	4 444 981.64	126	980 645.38	4 445 193.85	186	980 625.39	4 445 223.77
67	980 687.73	4 444 985.29	127	980 645.26	4 445 194.82	187	980 561.62	4 445 549.5
68	980 676.33	4 444 983.52	128	980 646.26	4 445 195	188	980 561.55	4 445 546.49
69	980 676.64	4 444 982.18	129	980 636.94	4 445 244.94	189	980 565.57	4 445 546.39
70	980 688.04	4 444 983.89	130	980 592.83	4 445 437.71	190	980 565.63	4 445 549.4
71	980 647.73	4 445 087.31	131	980 562.02	4 445 637.44	191	980 614.27	4 445 274.07
72	980 644.73	4 445 086.92	132	980 554.12	4 445 636.22	192	980 614.2	4 445 271.06
73	980 685.55	4 444 982.97	133	980 552.82	4 445 648.31	193	980 618.22	4 445 270.96
74	980 669.89	4 444 993.63	134	980 550.38	4 445 648.24	194	980 618.28	4 445 273.97
75	980 664.62	4 445 089.53	135	980 535.32	4 445 747.01	195	980 568.78	4 445 501.95
76	980 651.65	4 445 087.82	136	980 532.35	4 445 746.59	196	980 566.54	4 445 501.63
77	980 673.79	4 444 994.24	137	980 534.69	4 445 729.72	197	980 566.57	4 445 501.41
78	980 685.35	4 444 996.03	138	980 534.84	4 445 727.97	198	980 565.59	4 445 501.28
79	980 656.06	4 445 087.67	139	980 537.81	4 445 728.36	199	980 565.89	4 445 499.06
80	980 653.28	4 445 087.12	140	980 537.67	4 445 730.11	200	980 567.98	4 445 499.38
81	980 654.67	4 445 080.79	141	980 651.59	4 445 111.33	201	980 567.95	4 445 499.61
82	980 657.42	4 445 081.32	142	980 651.41	4 445 108.32	202	980 569.14	4 445 499.79
83	980 676.35	4 445 002.86	143	980 655.42	4 445 108.22	203	980 609.15	4 445 296.09
84	980 676.28	4 444 999.85	144	980 655.49	4 445 111.23	204	980 606.95	4 445 295.6
85	980 680.3	4 444 999.71	145	980 538.86	4 445 715.86	205	980 607.43	4 445 293.44
86	980 680.36	4 445 002.72	146	980 538.8	4 445 712.86	206	980 609.68	4 445 293.96
87	980 663.91	4 445 057.1	147	980 542.81	4 445 712.76	207	980 569.27	4 445 494.07
88	980 663.85	4 445 054.08	148	980 542.88	4 445 715.76	208	980 569.21	4 445 491.06
89	980 667.86	4 445 053.99	149	980 640.46	4 445 155.74	209	980 573.22	4 445 490.91
90	980 667.92	4 445 057	150	980 638.25	4 445 156.25	210	980 573.29	4 445 493.92
91	980 673.22	4 445 008.75	151	980 638.73	4 445 153.08	211	980 601.95	4 445 328.3
92	980 671.02	4 445 008.27	152	980 640.89	4 445 153.6	212	980 601.77	4 445 325.34
93	980 671.5	4 445 006.12	153	980 543.51	4 445 688.42	213	980 605.78	4 445 325.19
94	980 673.74	4 445 006.63	154	980 540.53	4 445 689	214	980 605.96	4 445 326.2
95	980 523.56	4 445 754.58	155	980 542.88	4 445 671.12	215	980 575	4 445 433.88
96	980 511.02	4 445 754.31	156	980 541.23	4 445 670.94	216	980 576.72	4 445 431.39
97	980 515.31	4 445 751.38	157	980 545.3	4 445 629.88	217	980 578.86	4 445 431.9
98	980 516.19	4 445 745.04	158	980 548.36	4 445 630.21	218	980 578.41	4 445 433.78
99	980 518.14	4 445 743.55	159	980 549.17	4 445 624.37	219	980 581.02	4 445 433.7
100	980 519.6	4 445 733.07	160	980 552.15	4 445 624.78	220	980 581.09	4 445 436.71
101	980 525.84	4 445 676.64	161	980 549.79	4 445 641.67	221	980 577.89	4 445 436.8
102	980 545.26	4 445 534.62	162	980 548.62	4 445 641.25	222	980 577.74	4 445 437.97
103	980 560.95	4 445 432.29	163	980 543.33	4 445 671.18	223	980 575.56	4 445 437.68
104	980 568.57	4 445 399.35	164	980 545.86	4 445 671.53	224	980 575.07	4 445 436.88
105	980 617.72	4 445 178.13	165	980 639.14	4 445 165.61	225	980 593.45	4 445 366.06
106	980 635.22	4 445 100.84	166	980 639.07	4 445 162.6	226	980 591.25	4 445 365.56
107	980 633.97	4 445 097.12	167	980 642.98	4 445 162.44	227	980 591.73	4 445 363.41
108	980 645.05	4 445 098.58	168	980 643.15	4 445 165.45	228	980 593.98	4 445 363.92
109	980 568.74	4 445 421	169	980 554.07	4 445 604.99	229	980 589.5	4 445 382.58
110	980 524.78	4 445 747.56	170	980 554.01	4 445 601.99	230	980 589.44	4 445 379.57

Номер	X	Y	Номер	X	Y	Номер	X	Y
234	980 513.2	4 445 795.74	294	978 522.66	4 447 063.83	354	976 537.32	4 449 726.46
235	980 510.23	4 445 795.34	295	978 492.84	4 447 098.3	355	976 540.9	4 449 726.06
236	980 515.03	4 445 760.53	296	979 491.75	4 447 098.38	356	976 540.81	4 449 724.3
237	980 522.57	4 445 760.69	297	979 492.36	4 447 098.85	357	976 589.44	4 449 719.21
238	980 519.96	4 445 776.28	298	979 384.34	4 447 223.66	358	976 589.52	4 449 721.63
239	980 517.99	4 445 775.98	299	979 349.71	4 447 259.72	359	976 593.53	4 449 721.53
240	980 517.62	4 445 777.91	300	979 329.06	4 447 282.95	360	976 593.46	4 449 718.79
241	980 519.62	4 445 778.26	301	979 304.79	4 447 310.96	361	976 645.59	4 449 713.35
242	980 511.5	4 445 826.75	302	979 270.45	4 447 349.15	362	976 645.67	4 449 715.23
243	980 515.45	4 445 826.66	303	979 264.67	4 447 365.62	363	976 649.57	4 449 715.07
244	980 525.59	4 445 766.44	304	978 948.45	4 447 711.86	364	976 649.49	4 449 712.94
245	980 531.33	4 445 776.09	305	978 941.3	4 447 712.6	365	976 967.26	4 449 679.78
246	980 530.79	4 445 780.04	306	978 945.53	4 447 715.16	366	976 967.44	4 449 682.67
247	980 527.77	4 445 779.63	307	978 915.42	4 447 749.08	367	976 973.47	4 449 682.27
248	980 525.48	4 445 796.49	308	978 907.75	4 447 765.88	368	976 973.18	4 449 679.17
249	980 528.47	4 445 798.89	309	978 904.86	4 447 753.56	369	977 029.03	4 449 673.34
250	980 525.96	4 445 814.94	310	978 905.49	4 447 757.89	370	977 067.16	4 449 664.2
251	980 523.09	4 445 814.59	311	978 894.07	4 447 768.01	371	977 067.46	4 449 666.47
252	980 522.37	4 445 821.05	312	978 891.81	4 447 770.45	372	977 068.87	4 449 666.28
253	980 525.11	4 445 821.28	313	978 855.77	4 447 810.54	373	977 069.71	4 449 666.05
254	980 524.4	4 445 826.43	314	978 812.7	4 447 858.76	374	977 087.04	4 449 661.46
255	980 522.64	4 445 835.53	315	978 788.8	4 447 885.34	375	977 086.53	4 449 659.56
256	980 522.04	4 445 839.88	316	978 769.18	4 447 907.68	376	977 136.56	4 449 647.55
257	980 519.96	4 445 839.58	317	978 728.1	4 447 954.63	377	977 142.4	4 449 644.31
258	980 519.65	4 445 841.78	318	978 599.65	4 448 087.42	378	977 142.96	4 449 646.35
259	980 521.73	4 445 842.06	319	978 476.01	4 448 237.12	379	977 153.22	4 449 644.51
260	980 521.45	4 445 844.12	320	978 284.51	4 448 455.54	380	977 158.72	4 449 641.9
261	980 512.48	4 445 844.4	321	978 220.98	4 448 527.07	381	977 159.68	4 449 641.17
262	980 514.44	4 445 832.72	322	978 074.94	4 448 689.06	382	977 157.69	4 449 637.4
263	980 522.56	4 445 832.5	323	978 033.92	4 448 734.64	383	977 150.25	4 449 641.29
264	980 505.74	4 445 884.31	324	977 894.49	4 448 892.34	384	977 145.57	4 449 642.54
265	980 510.41	4 445 858.57	325	977 787.89	4 449 012.9	385	977 233.87	4 449 592.86
266	980 520.16	4 445 856.24	326	977 709.89	4 449 098.13	386	977 692.12	4 449 083.85
267	980 516.07	4 445 883.92	327	977 707.49	4 449 096.17	387	978 259.51	4 448 452.04
268	980 514.43	4 445 883.91	328	977 534.31	4 449 297.78	388	978 269	4 448 441.35
269	980 512.96	4 445 899.69	329	977 497.89	4 449 334.16	389	978 268.27	4 448 442.72
270	980 506.17	4 445 913.26	330	977 290.42	4 449 559.35	390	978 267.3	4 448 444.56
271	980 496.13	4 445 927.77	331	977 227.31	4 449 618.6	391	978 268.94	4 448 446.02
272	980 493.02	4 445 927.86	332	977 155.97	4 449 655.9	392	978 270.8	4 448 444.18
273	980 493.08	4 445 930.87	333	977 071.06	4 449 678.68	393	978 275.09	4 448 444.02
274	980 494.01	4 445 930.85	334	976 970.75	4 449 689.89	394	978 275.02	4 448 441.06
275	980 482.9	4 445 946.8	335	976 528.3	4 449 738.44	395	978 272.8	4 448 441.12
276	980 477.89	4 445 944.22	336	976 139.28	4 449 776.23	396	978 271.43	4 448 439.9
277	980 487.17	4 445 960.17	337	975 890.71	4 449 802.29	397	978 269.07	4 448 441.21
278	980 470.76	4 445 962.69	338	975 869.95	4 449 804.47	398	978 421.51	4 448 269.32
279	980 469.53	4 445 964.13	339	975 858.54	4 449 805.66	399	978 422.74	4 448 270.48
280	980 468.67	4 445 965.76	340	975 849.79	4 449 806.58	400	978 424.28	4 448 268.9
281	980 469.66	4 445 966.66	341	975 843.01	4 449 806.75	401	978 422.98	4 448 267.67
282	980 469.68	4 445 967.21	342	975 842.74	4 449 804.5	402	978 471.17	4 448 213.3
283	980 475.7	4 445 967.02	343	975 822.78	4 449 805.35	403	978 472.26	4 448 214.29
284	980 475.68	4 445 966.13	344	975 822.58	4 449 803.73	404	978 476.39	4 448 209.62
285	980 481.7	4 445 970.35	345	975 822.38	4 449 801.64	405	978 475.28	4 448 208.66
286	980 483.55	4 445 971.45	346	975 851.61	4 449 799.79	406	978 523.74	4 448 154.01
287	980 482.94	4 445 972.48	347	976 312.59	4 449 747.96	407	978 524.63	4 448 154.62
288	980 385.84	4 446 081.69	348	976 476.6	4 449 730.99	408	978 526.17	4 448 153.25
289	980 393.89	4 446 097.02	349	976 528.49	4 449 725.59	409	978 525.22	4 448 152.34
290	980 374.49	4 446 120.33	350	976 528.59	4 449 726.44	410	978 574.82	4 448 096.39

Номер	X	Y	Номер	X	Y	Номер	X	Y
414	978 626	4 448 038.69	473	977 249.69	4 449 577.44	532	980 266.36	4 446 193.16
415	978 627.03	4 448 039.64	474	977 253.71	4 449 577.28	533	980 268.04	4 446 194.74
416	978 628.56	4 448 038.04	475	977 253.77	4 449 580.29	534	977 438.61	4 449 379.63
417	978 627.47	4 448 037.02	476	980 380.81	4 446 104.41	535	977 436.96	4 449 378.09
418	978 675.72	4 447 982.61	477	980 377.92	4 446 098.67	536	977 438.45	4 449 376.48
419	978 676.85	4 447 983.71	478	980 380.76	4 446 098.21	537	977 440.14	4 449 378.06
420	978 681.01	4 447 978.97	479	980 383.15	4 446 102.99	538	980 226.09	4 446 240.8
421	978 679.86	4 447 977.96	480	977 277.78	4 449 553.43	539	980 226.02	4 446 237.58
422	978 968.88	4 447 652.01	481	977 278.28	4 449 551.82	540	980 232.04	4 446 237.41
423	979 574.62	4 446 870.02	482	977 278.39	4 449 549.01	541	980 232.11	4 446 240.42
424	980 033.33	4 446 455.05	483	977 280.84	4 449 547.39	542	977 446.58	4 449 371.2
425	980 342.09	4 446 103.06	484	977 280.84	4 449 547.4	543	977 446.51	4 449 368.19
426	980 500.96	4 445 912.76	485	977 280.85	4 449 547.39	544	977 450.52	4 449 368.08
427	980 503.87	4 445 895.42	486	977 282.38	4 449 548.9	545	977 450.59	4 449 371.04
428	980 510.78	4 445 895.1	487	977 284.43	4 449 548.85	546	980 215.36	4 446 253.98
429	980 507.96	4 445 899.89	488	977 284.5	4 449 551.86	547	980 213.71	4 446 252.42
430	980 510.54	4 445 901.41	489	977 279.33	4 449 552.01	548	980 215.21	4 446 250.82
431	980 512.94	4 445 897.29	490	980 343.85	4 446 110.76	549	980 216.9	4 446 252.4
432	976 413.27	4 449 740.63	491	980 343.58	4 446 107.75	550	977 489.32	4 449 322.96
433	976 413.09	4 449 737.66	492	980 347.59	4 446 107.85	551	977 488.53	4 449 322.17
434	976 417.1	4 449 737.51	493	980 347.66	4 446 110.86	552	977 493.07	4 449 317.64
435	976 417.17	4 449 740.52	494	977 322.03	4 449 506.74	553	977 494.61	4 449 319.2
436	980 425.06	4 446 019.33	495	977 321.96	4 449 503.78	554	977 490.91	4 449 322.91
437	980 424.9	4 446 016.37	496	977 325.98	4 449 503.62	555	977 492.08	4 449 322.87
438	980 428.8	4 446 016.06	497	977 326.05	4 449 506.63	556	977 492.14	4 449 325.88
439	980 429.09	4 446 019.01	498	980 378.02	4 446 113.25	557	977 486.12	4 449 326.07
440	976 473.31	4 449 734.49	499	980 375.79	4 446 111.25	558	977 486.06	4 449 323.05
441	976 473.25	4 449 731.48	500	980 377.8	4 446 109.02	559	980 189.76	4 446 283.56
442	976 477.26	4 449 731.37	501	980 380.03	4 446 111.03	560	980 189.59	4 446 280.55
443	976 477.33	4 449 734.33	502	977 332.47	4 449 494.57	561	980 189.6	4 446 280.45
444	980 420.37	4 446 023.46	503	977 330.82	4 449 493.02	562	980 193.78	4 446 283.46
445	980 418.72	4 446 021.92	504	977 332.32	4 449 491.41	563	977 521.08	4 449 290.06
446	980 420.22	4 446 020.31	505	977 334	4 449 492.99	564	977 521.02	4 449 287.05
447	980 420.23	4 446 020.31	506	980 317.77	4 446 138.66	565	977 527.04	4 449 286.87
448	980 420.23	4 446 020.31	507	980 316.11	4 446 137.12	566	977 527.1	4 449 289.88
449	980 421.91	4 446 021.88	508	980 317.81	4 446 135.5	567	980 184.11	4 446 311.52
450	977 185.92	4 449 625.94	509	980 319.31	4 446 137.08	568	980 182.46	4 446 309.98
451	977 185.74	4 449 622.98	510	977 363.58	4 449 481.58	569	980 183.97	4 446 308.37
452	977 189.75	4 449 622.83	511	977 363.51	4 449 458.57	570	980 165.65	4 446 309.96
453	977 189.93	4 449 625.84	512	977 367.41	4 449 458.46	571	977 549.48	4 449 258.2
454	980 363.46	4 446 065.97	513	977 367.6	4 449 461.42	572	977 551.75	4 449 258.17
455	980 383.39	4 446 062.96	514	980 309.28	4 446 149.4	573	977 546.58	4 449 264.2
456	980 387.4	4 446 062.86	515	980 309.22	4 446 146.39	574	977 545.05	4 449 265.98
457	980 387.47	4 446 065.87	516	980 313.23	4 446 146.29	575	977 540.7	4 449 271.05
458	977 212.24	4 449 612.36	517	980 313.29	4 446 149.3	576	977 538.42	4 449 269.1
459	977 210.85	4 449 609.88	518	977 385.6	4 449 436.89	577	977 542.85	4 449 264.16
460	977 218.43	4 449 605.17	519	977 383.95	4 449 435.36	578	977 544.36	4 449 262.18
461	977 224.27	4 449 600.16	520	977 385.45	4 449 433.74	579	980 151.66	4 446 326.29
462	977 226.33	4 449 602.34	521	977 387.13	4 449 435.31	580	980 151.48	4 446 323.28
463	977 224.44	4 449 605.09	522	980 286.68	4 446 194.94	581	980 155.5	4 446 323.18
464	977 224.49	4 449 609.07	523	980 288.62	4 446 191.97	582	980 155.67	4 446 326.19
465	977 218.56	4 449 609.3	524	980 272.64	4 446 191.83	583	977 561.53	4 449 244.4
466	980 369.24	4 446 084.16	525	980 272.71	4 446 194.84	584	977 561.46	4 449 241.44
467	980 366.13	4 446 081.09	526	977 405.13	4 449 416.36	585	977 565.48	4 449 241.28
468	980 370.3	4 446 076.4	527	977 404.96	4 449 413.34	586	977 565.55	4 449 244.29
469	980 373.48	4 446 079.63	528	977 408.97	4 449 413.24	587	980 111.15	4 446 366.4

Номер	X	Y	Номер	X	Y	Номер	X	Y
591	980 116.06	4 446 366.25	651	977 738.42	4 449 042.47	711	979 812.2	4 446 709.19
592	980 117.17	4 446 366.22	652	979 961.92	4 446 540.09	712	977 905.66	4 448 853.09
593	980 117.23	4 446 369.23	653	979 960.27	4 446 538.55	713	977 904.01	4 448 851.54
594	980 113.33	4 446 369.35	654	979 961.77	4 446 536.93	714	977 905.51	4 448 849.92
595	980 108.18	4 446 375.08	655	979 963.45	4 446 538.51	715	977 907.2	4 448 851.49
596	980 106.96	4 446 373.07	656	977 750.12	4 449 028.57	716	979 812.97	4 446 713.44
597	980 111.18	4 446 367.3	657	977 748.47	4 449 027.02	717	979 812.9	4 446 710.48
598	977 594.11	4 449 202.66	658	977 749.96	4 449 025.41	718	979 816.92	4 446 710.33
599	977 598.13	4 449 202.56	659	977 751.65	4 449 026.89	719	979 816.98	4 446 713.34
600	977 598.2	4 449 205.57	660	979 963.47	4 446 541.84	720	977 938.09	4 448 816.29
601	977 596.5	4 449 205.61	661	979 963.41	4 446 538.83	721	977 938.02	4 448 813.27
602	977 595.57	4 449 206.74	662	979 967.42	4 446 538.73	722	977 942.03	4 448 813.17
603	977 594.19	4 449 205.67	663	979 967.49	4 446 541.74	723	977 942.1	4 448 816.18
604	977 594.18	4 449 205.67	664	977 775.19	4 448 997.31	724	979 774.77	4 446 755.75
605	977 594.18	4 449 205.66	665	977 775.01	4 448 994.3	725	979 774.7	4 446 752.14
606	977 593.79	4 449 205.35	666	977 779.02	4 448 994.19	726	979 778.72	4 446 752.64
607	977 594.16	4 449 204.88	667	977 779.09	4 448 997.2	727	979 778.78	4 446 755.59
608	980 075.78	4 446 412.44	668	979 926.04	4 446 584.95	728	977 957.49	4 448 794.2
609	980 075.71	4 446 409.43	669	979 925.97	4 446 581.95	729	977 955.84	4 448 792.66
610	980 079.73	4 446 409.33	670	979 928.98	4 446 581.84	730	977 957.34	4 448 791.04
611	980 079.79	4 446 412.35	671	979 930.05	4 446 584.85	731	977 959.02	4 448 792.82
612	977 626.95	4 449 166.9	672	977 802.04	4 448 970	732	979 760.49	4 446 767.74
613	977 626.89	4 449 163.93	673	977 800.39	4 448 968.46	733	979 760.48	4 446 767.73
614	977 630.79	4 449 183.78	674	977 801.89	4 448 966.84	734	979 760.49	4 446 767.74
615	977 630.97	4 449 186.79	675	977 803.57	4 448 968.43	735	979 758.83	4 446 766.19
616	980 062.38	4 446 426.14	676	979 911.32	4 448 597.04	736	979 760.35	4 446 764.58
617	980 060.73	4 446 424.6	677	979 909.67	4 446 595.5	737	979 762.03	4 446 766.16
618	980 062.23	4 446 422.98	678	979 911.18	4 446 593.86	738	977 978.86	4 448 771.01
619	980 063.91	4 446 424.55	679	979 912.86	4 446 595.45	739	977 978.79	4 448 768
620	977 647.08	4 449 148.36	680	977 815.86	4 448 952.04	740	977 982.7	4 448 767.9
621	977 645.43	4 449 144.82	681	977 815.79	4 448 949.02	741	977 982.88	4 448 770.91
622	977 648.92	4 449 143.2	682	977 819.8	4 448 948.92	742	979 736.57	4 446 797.99
623	977 648.62	4 449 144.78	683	977 819.87	4 448 951.94	743	979 736.5	4 446 795.04
624	980 038.35	4 446 455.56	684	979 888.6	4 446 628.07	744	979 740.51	4 446 794.88
625	980 038.28	4 446 452.54	685	979 888.53	4 446 625.06	745	979 740.58	4 446 797.89
626	980 042.3	4 446 452.45	686	979 892.55	4 446 624.96	746	978 009.4	4 448 735.84
627	980 042.36	4 446 455.46	687	979 892.61	4 446 627.97	747	978 007.75	4 448 734.3
628	977 659.5	4 449 128.27	688	977 853.85	4 448 911.53	748	978 009.26	4 448 732.68
629	977 659.43	4 449 125.26	689	977 852.2	4 448 910	749	978 010.93	4 448 734.26
630	977 663.45	4 449 125.16	690	977 853.7	4 448 908.39	750	979 710.1	4 446 824.7
631	977 663.52	4 449 128.17	691	977 855.38	4 448 909.96	751	979 708.45	4 446 823.15
632	980 012.2	4 446 483.21	692	979 861.13	4 446 653.91	752	979 709.85	4 446 821.55
633	980 010.55	4 446 481.87	693	979 859.51	4 446 652.37	753	979 711.64	4 446 823.12
634	980 012.04	4 446 480.06	694	979 861.01	4 446 650.76	754	978 019.53	4 446 725.75
635	980 013.73	4 446 481.64	695	979 862.68	4 446 652.33	755	978 019.47	4 448 722.74
636	977 691.55	4 449 084.91	696	977 856.64	4 448 906.76	756	978 023.49	4 448 722.63
637	977 696.9	4 449 084.75	697	977 856.57	4 448 903.75	757	978 023.55	4 448 725.65
638	977 702.55	4 449 078.24	698	977 860.58	4 448 903.65	758	979 698.48	4 446 840.3
639	977 704.8	4 449 080.21	699	977 860.85	4 448 906.66	759	979 698.3	4 446 837.29
640	977 693.68	4 449 093.03	700	979 849.16	4 446 671.27	760	979 702.31	4 446 837.18
641	977 691.41	4 449 091.09	701	979 849.09	4 446 668.26	761	979 702.38	4 446 840.14
642	977 694.21	4 449 087.86	702	979 855.12	4 446 668.08	762	978 058.24	4 446 677.56
643	977 691.62	4 449 087.93	703	979 855.19	4 446 671.09	763	978 060.86	4 448 677.47
644	980 000.91	4 446 498.72	704	977 897.31	4 448 861.55	764	978 059.23	4 448 676.13
645	980 000.85	4 446 495.71	705	977 897.24	4 448 858.54	765	978 060.74	4 448 674.52
646	980 004.86	4 446 495.61	706	977 901.25	4 448 858.44	766	978 062.42	4 448 676.1
647	980 004.92	4 446 496.62	707	977 901.32	4 448 861.45	767	978 061.09	4 448 677.48
			708	979 810.67	4 446 710.76			

Номер	X	Y	Номер	X	Y	Номер	X	Y
771	979 660.28	4 446 882.55	831	979 505.3	4 447 048.79	891	979 358.46	4 447 221.49
772	979 659.42	4 446 881.65	832	979 508.47	4 447 048.69	892	979 360.15	4 447 223.08
773	979 657.96	4 446 880.11	833	978 213.67	4 448 508.76	893	978 423.67	4 448 275.89
774	979 659.47	4 446 878.5	834	978 211.44	4 448 506.76	894	978 423.49	4 448 272.88
775	979 660.84	4 446 879.57	835	978 216	4 448 501.68	895	978 427.51	4 448 272.78
776	979 664.12	4 446 879.44	836	978 217.58	4 448 499.92	896	978 427.57	4 448 275.73
777	979 664.3	4 446 882.45	837	978 222.77	4 448 494.11	897	979 323.71	4 447 265.97
778	978 096.23	4 448 641.01	838	978 225.01	4 448 498.1	898	979 323.65	4 447 263.02
779	978 096.16	4 448 638.05	839	978 219.75	4 448 501.97	899	979 327.66	4 447 262.86
780	978 100.17	4 448 637.89	840	978 218.23	4 448 503.07	900	979 327.73	4 447 265.87
781	978 100.24	4 448 640.91	841	979 470.62	4 447 094.59	901	978 460.29	4 448 233.86
782	979 621.97	4 446 924.91	842	979 470.55	4 447 091.58	902	978 460.22	4 448 230.85
783	979 621.91	4 446 921.9	843	979 474.57	4 447 091.43	903	978 466.24	4 448 230.67
784	979 625.92	4 446 921.8	844	979 474.63	4 447 094.45	904	978 466.31	4 448 233.68
785	979 625.99	4 446 924.81	845	978 236.39	4 448 483.5	905	979 308.43	4 447 281.73
786	978 113.64	4 448 619.25	846	978 236.22	4 448 480.49	906	979 306.78	4 447 280.19
787	978 111.99	4 448 617.72	847	978 240.23	4 448 480.38	907	979 308.28	4 447 278.57
788	978 113.48	4 448 616.1	848	978 240.3	4 448 483.39	908	979 309.97	4 447 280.15
789	978 115.18	4 448 617.68	849	979 458.67	4 447 110.06	909	978 499.37	4 448 191.43
790	979 609.33	4 446 936.62	850	979 457.02	4 447 108.52	910	978 499.3	4 448 188.42
791	979 607.68	4 446 937.08	851	979 458.53	4 447 106.91	911	978 503.31	4 448 188.32
792	979 609.18	4 446 935.47	852	979 460.21	4 447 108.49	912	978 503.38	4 448 191.27
793	979 610.87	4 446 937.06	853	978 307.58	4 448 402.19	913	978 284.95	4 447 308.93
794	978 132.13	4 448 601.59	854	978 307.52	4 448 399.23	914	978 284.88	4 447 305.92
795	978 131.96	4 448 598.58	855	978 311.42	4 448 399.07	915	979 290.91	4 447 305.73
796	978 135.97	4 448 598.47	856	978 311.6	4 448 402.08	916	979 290.98	4 447 308.75
797	978 138.15	4 448 601.49	857	979 433.98	4 447 137.42	917	978 536.43	4 448 149.03
798	979 583.77	4 446 967.17	858	979 433.92	4 447 134.41	918	978 536.25	4 448 146.06
799	979 583.71	4 446 964.21	859	979 437.82	4 447 134.3	919	978 540.27	4 448 145.91
800	979 587.72	4 448 964.05	860	979 438	4 447 137.32	920	978 540.44	4 448 148.93
801	979 587.79	4 446 967.06	861	978 321.14	4 448 386.66	921	979 258.66	4 447 339.04
802	978 167.93	4 448 562.12	862	978 319.49	4 448 385.13	922	979 257	4 447 337.49
803	978 167.86	4 448 559.15	863	978 320.99	4 448 383.5	923	979 258.51	4 447 335.89
804	978 171.88	4 448 559	864	978 322.68	4 448 385.09	924	979 260.19	4 447 337.46
805	978 171.94	4 448 562.02	865	979 408.49	4 447 167.25	925	978 573.39	4 448 106.67
806	979 558.95	4 446 985.59	866	979 408.84	4 447 165.71	926	978 573.32	4 448 103.66
807	979 557.3	4 446 994.05	867	979 408.34	4 447 164.09	927	978 577.34	4 448 103.56
808	979 558.8	4 446 992.43	868	979 410.02	4 447 165.87	928	978 577.4	4 448 106.57
809	979 560.48	4 446 994.02	869	978 346.2	4 448 360.12	929	979 248.43	4 447 351.43
810	978 168.06	4 448 561.13	870	978 346.13	4 448 357.11	930	979 248.37	4 447 348.42
811	978 164.41	4 448 559.59	871	978 350.14	4 448 356.96	931	978 252.38	4 447 348.32
812	978 165.9	4 448 557.98	872	978 350.21	4 448 359.97	932	979 252.45	4 447 351.33
813	978 165.91	4 448 557.99	873	979 397.11	4 447 180.78	933	978 610.58	4 448 064.27
814	978 165.91	4 448 557.96	874	979 397.05	4 447 177.33	934	978 610.4	4 448 061.26
815	978 167.6	4 448 559.56	875	979 401.06	4 447 177.17	935	978 614.41	4 448 061.16
816	979 545.58	4 447 009.47	876	979 401.13	4 447 180.18	936	978 614.59	4 448 064.12
817	979 545.51	4 447 006.46	877	978 371.99	4 448 328.69	937	979 216.72	4 447 384.91
818	979 549.52	4 447 006.36	878	978 370.34	4 448 327.13	938	979 215.07	4 447 383.36
819	979 549.59	4 447 009.31	879	978 371.84	4 448 325.53	939	979 216.58	4 447 381.76
820	978 201.82	4 448 522.78	880	978 373.52	4 448 327.1	940	979 218.25	4 447 383.33
821	978 201.76	4 448 519.76	881	979 380.47	4 447 223.16	941	978 647.54	4 448 021.87
822	978 207.78	4 448 519.58	882	979 380.29	4 447 220.15	942	978 647.47	4 448 018.92
823	978 207.84	4 448 522.59	883	979 364.3	4 447 220.04	943	978 651.48	4 448 018.76
824	979 509.86	4 447 048.65	884	979 364.48	4 447 223.05	944	978 651.55	4 448 021.77
825	979 511.32	4 447 048.81	885	978 384.93	4 448 318.01	945	979 210.01	4 447 394.12
826	979 511.39	4 447 051.62	886	978 384.87	4 448 314.99	946	979 209.94	4 447 391.16
827	979 509.46	4 447 051.68	887	978 388.88	4 448 314.89	947	979 213.85	4 447 391.01

Номер	X	Y	Номер	X	Y	Номер	X	Y
951	978 688 56	4 447 976.41	1 011	979 031.39	4 447 594.33	1 071	980 497.4	4 445 910.9
952	978 688 62	4 447 979.42	1 012	978 833.57	4 447 809.83	1 072	980 475.92	4 445 936.63
953	979 174.56	4 447 431.08	1 013	978 834.73	4 447 809.11	1 073	980 475.91	4 445 936.64
954	979 172.91	4 447 429.54	1 014	978 835.45	4 447 809.78	1 074	977 689.15	4 449 081.23
955	979 174.42	4 447 427.83	1 015	978 837.58	4 447 809.73	1 075	977 684.08	4 449 075.62
956	979 176.1	4 447 429.51	1 016	978 837.65	4 447 812.69	1 076	977 759.41	4 448 987.75
957	978 714.64	4 447 945.94	1 017	978 833.64	4 447 812.84	1 077	977 866.02	4 448 867.17
958	978 714.46	4 447 942.93	1 018	978 833.6	4 447 811.07	1 078	978 046.61	4 448 663.74
959	978 718.47	4 447 942.83	1 019	978 833.23	4 447 810.72	1 079	978 192.65	4 448 501.73
960	978 718.54	4 447 945.84	1 020	979 021.72	4 447 806.18	1 080	978 256.01	4 448 430.4
961	979 171.37	4 447 436.64	1 021	979 021.86	4 447 803.17	1 081	978 447.62	4 448 211.87
962	979 171.3	4 447 433.63	1 022	979 027.68	4 447 803	1 082	978 843.67	4 447 773.14
963	979 175.31	4 447 433.53	1 023	979 027.74	4 447 806.01	1 083	979 007.05	4 447 591.77
964	979 175.38	4 447 436.54	1 024	978 855.42	4 447 786.62	1 084	979 118.19	4 447 462.88
965	978 730.32	4 447 925.39	1 025	978 855.36	4 447 783.61	1 085	979 244.47	4 447 324.82
966	978 728.66	4 447 923.84	1 026	978 860.71	4 447 783.47	1 086	979 494.12	4 447 038.75
967	978 730.18	4 447 922.24	1 027	978 860.77	4 447 786.48	1 087	979 763.7	4 446 711
968	978 731.86	4 447 923.81	1 028	978 982.04	4 447 651.22	1 088	979 787.44	4 446 714.31
969	979 128.35	4 447 482.35	1 029	978 981.86	4 447 648.21	1 089	980 358.57	4 446 070.14
970	979 126.11	4 447 480.36	1 030	978 985.88	4 447 648.11	1 090	980 454.07	4 445 962.8
971	979 130.46	4 447 476.47	1 031	978 986.05	4 447 651.12	1 091	980 339.12	4 446 100.54
972	979 132.08	4 447 473.65	1 032	978 875.43	4 447 768.62	1 092	980 030.48	4 446 452.43
973	979 137.43	4 447 467.64	1 033	978 873.35	4 447 766.72	1 093	979 571.63	4 446 967.41
974	979 139.68	4 447 469.64	1 034	978 877.6	4 447 761.94	1 094	978 965.91	4 447 849.42
975	979 134.26	4 447 475.73	1 035	978 879.73	4 447 763.78	1 095	978 256.51	4 448 449.39
976	979 133.84	4 447 476.2	1 036	978 977.41	4 447 654.55	1 096	980 378.82	4 446 128.66
977	979 136.78	4 447 476.12	1 037	978 975.76	4 447 653.01	1 097	980 377.5	4 446 126.13
978	979 136.85	4 447 479.13	1 038	978 977.27	4 447 651.39	1 098	980 396.92	4 446 102.8
979	979 130.83	4 447 479.3	1 039	978 978.95	4 447 652.97	1 099	980 398.64	4 446 106.08
980	978 744.56	4 447 912.36	1 040	978 888.87	4 447 751.3	1 100	980 386.55	4 446 143.62
981	978 744.49	4 447 909.35	1 041	978 891.38	4 447 746.24	1 101	980 379.85	4 446 130.67
982	978 748.51	4 447 909.25	1 042	978 893.62	4 447 748.23	1 102	980 399.62	4 448 110.08
983	978 748.57	4 447 912.26	1 043	978 889.05	4 447 753.37	1 103	980 399.59	4 446 110.07
984	979 096.43	4 447 521.52	1 044	978 887.46	4 447 755.15	1 104	980 399.6	4 446 110.06
985	979 096.36	4 447 518.51	1 045	978 882.29	4 447 760.95	1 105	980 398.1	4 446 108.62
986	979 100.37	4 447 518.41	1 046	978 880.05	4 447 758.95	1 106	980 399.2	4 446 107.18
987	979 100.44	4 447 521.42	1 047	978 885.26	4 447 753.1	1 107	980 405.99	4 446 120.26
988	978 768.7	4 447 885.15	1 048	978 940.24	4 447 698.35	1 108	980 398.74	4 446 165.77
989	978 768.76	4 447 881.11	1 049	978 940.18	4 447 693.34	1 109	980 397.66	4 446 165.35
990	978 774.66	4 447 881.15	1 050	978 944.19	4 447 693.23	1 110	980 387.16	4 446 144.73
991	978 774.71	4 447 885.13	1 051	978 944.26	4 447 696.19	1 111	980 406.49	4 446 121.22
992	979 081.2	4 447 536.38	1 052	978 898.56	4 447 741.46	1 112	980 420.18	4 446 147.25
993	979 079.55	4 447 534.84	1 053	978 898.49	4 447 738.45	1 113	980 416.22	4 446 155.74
994	979 081.05	4 447 533.22	1 054	978 902.39	4 447 738.35	1 114	980 407.7	4 446 150.72
995	979 082.74	4 447 534.8	1 055	978 902.57	4 447 741.36	1 115	980 404.85	4 446 154.91
996	978 782.76	4 447 868.73	1 056	978 934.79	4 447 702.23	1 116	980 407.01	4 446 156.02
997	978 781.13	4 447 867.19	1 057	978 932.71	4 447 700.33	1 117	980 408.73	4 446 156.91
998	978 782.83	4 447 865.58	1 058	978 936.96	4 447 695.55	1 118	980 410.25	4 446 157.67
999	978 784.32	4 447 867.16	1 059	978 939.09	4 447 697.39	1 119	980 410.02	4 446 158.2
1 000	979 060.14	4 447 563.81	1 060	978 920.84	4 447 718.12	1 120	980 408.8	4 446 157.53
1 001	979 060.07	4 447 566.8	1 061	978 918.6	4 447 716.13	1 121	980 406.68	4 446 162.61
1 002	979 064.08	4 447 560.7	1 062	978 922.78	4 447 711.43	1 122	980 399.84	4 446 159.12
1 003	979 064.15	4 447 563.71	1 063	978 924.32	4 447 709.71	1 123	980 398.47	4 448 161.8
1 004	978 808.7	4 447 840.64	1 064	978 929.93	4 447 703.42	1 124	980 403.25	4 446 164.24
1 005	978 808.54	4 447 836.61	1 065	978 932.18	4 447 705.4	1 125	976 116.39	4 449 763.11
1 006	978 814.56	4 447 836.48	1 066	978 926.54	4 447 711.73	1 126	976 110.47	4 449 763.78
1 007	978 814.61	4 447 840.46	1 067	978 924.95	4 447 713.5	1 127	976 110.76	4 449 766.72

Перечень координат поворотных точек земельного участка
86.04.000001-10984-3У1

Номер	X	Y	Номер	X	Y
1 131	976 051.59	4 449 773.37	1 191	976 224.09	4 449 753.98
1 132	975 994.44	4 449 779.8	1 192	976 224.01	4 449 752.88
1 133	975 994.26	4 449 777.98	1 193	976 221.81	4 449 753.02
1 134	975 994.15	4 449 776.81	1 194	976 221.89	4 449 754.23
1 135	975 993.95	4 449 775.66	1 195	976 153.8	4 449 761.88
1 136	975 986.28	4 449 776.76	1 196	976 153.56	4 449 759.25
1 137	975 986.6	4 449 778.81	1 197	976 148.26	4 449 759.76
1 138	975 990.27	4 449 778.36	1 198	976 142.08	4 449 760.35
1 139	976 990.53	4 449 780.24	1 199	976 136.54	4 449 760.88
1 140	975 933.38	4 449 786.66	1 200	976 136.82	4 449 763.79
1 141	975 933.09	4 449 783.68	1 201	976 116.68	4 449 766.06
1 142	975 929.07	4 449 784.16	1 202	975 808.29	4 449 797.88
1 143	975 929.37	4 449 787.11	1 203	975 808.22	4 449 794.86
1 144	975 851.22	4 449 795.9	1 204	975 812.23	4 449 794.76
1 145	975 753.06	4 449 801.88	1 205	975 812.3	4 449 797.77
1 146	975 752.7	4 449 795.9	1 206	976 066.28	4 449 770.57
1 147	975 746.79	4 449 796.3	1 207	976 066.12	4 449 768.33
1 148	975 747.15	4 449 802.25	1 208	976 068.32	4 449 768.15
1 149	975 731.91	4 449 784.31	1 209	976 068.48	4 449 770.46
1 150	975 728.59	4 449 784.59	1 210	975 831.05	4 449 794.2
1 151	975 724.48	4 449 788.23	1 211	975 831.04	4 449 794.2
1 152	975 732.67	4 449 786.47	1 212	975 831	4 449 791.89
1 153	975 732.2	4 449 775.14	1 213	975 834.01	4 449 791.74
1 154	975 737.57	4 449 775.5	1 214	975 837.15	4 449 791.47
1 155	975 737.85	4 449 770.59	1 215	975 837.34	4 449 793.78
1 156	975 741.89	4 449 770.98	1 216	975 834.19	4 449 794.06
1 157	975 741.98	4 449 767.86	1 217	975 834.12	4 449 794.05
1 158	975 742.02	4 449 767.34	1 218	975 784.08	4 449 786.22
1 159	975 742.31	4 449 767.34	1 219	975 754.76	4 449 796.22
1 160	975 742.29	4 449 773.61	1 220	975 741.8	4 449 785.7
1 161	975 744.52	4 449 773.62	1 221	975 741.8	4 449 776.4
1 162	975 744.59	4 449 767.34	1 222	975 744.78	4 449 776.9
1 163	975 746.37	4 449 767.36	1 223	975 744.66	4 449 784.28
1 164	975 746.31	4 449 761.57	1 224	975 756.08	4 449 793.45
1 165	975 751.63	4 449 761.4	1 225	975 763.99	4 449 793.21
1 166	975 755.57	4 449 777.06	1 226	975 866.08	4 449 793.54
1 167	975 760.31	4 449 780.85	1 227	975 866.01	4 449 790.53
1 168	975 770.46	4 449 780.59	1 228	975 872.03	4 449 790.34
1 169	975 847.97	4 449 778.62	1 229	975 872.1	4 449 793.35
1 170	976 136.46	4 449 748.37	1 230	975 910.87	4 449 786.4
1 171	976 525.42	4 449 710.59	1 231	975 910.72	4 449 784.14
1 172	976 967.66	4 449 662.07	1 232	975 912.92	4 449 783.98
1 173	977 065.84	4 449 651.1	1 233	975 913.07	4 449 786.29
1 174	977 145.74	4 449 629.66			
1 175	977 210.85	4 449 595.57			
1 176	977 270.51	4 449 539.65			
1 177	977 284.74	4 449 530.51			
1 178	977 231.47	4 449 589.7			
1 179	977 135.06	4 449 843.93			
1 180	977 028.48	4 449 869.45			
1 181	977 004.16	4 449 871.98			
1 182	977 004.04	4 449 870.95			
1 183	976 997.68	4 449 871.69			
1 184	976 997.8	4 449 872.64			
1 185	976 924.38	4 449 880.31			
1 186	976 924.29	4 449 879.7			
1 187	976 922.1	4 449 880.03			

Перечень координат поворотных точек земельного участка 86.04.000001-11002-3У1

Номер	X	Y
1	954 233.28	4 431 796.01
2	954 243.26	4 431 210.81
3	954 242.99	4 431 169.91
4	954 241.26	4 431 167.75
5	954 240.47	4 431 167.68
6	954 240.85	4 431 142.94
7	954 242.85	4 431 142.95
8	954 242.37	4 430 973.01
9	954 242.62	4 430 904.23
10	954 242.63	4 430 902.54
11	954 242.64	4 430 901.22
12	954 243.06	4 430 834.88
13	954 243.86	4 430 779.66
14	954 272.28	4 430 781.04
15	954 273.38	4 430 970.47
16	954 275.11	4 431 268.51
17	954 275.11	4 431 268.53
18	954 275.11	4 431 268.59
19	954 273.16	4 431 366.33
20	954 249.81	4 431 787.97
21	954 251.15	4 431 749.73
22	954 248.85	4 431 749.68
23	954 248.89	4 431 747.48
24	954 251.19	4 431 747.53
25	954 255.89	4 430 832.82
26	954 255.88	4 430 830.62
27	954 258.17	4 430 830.61
28	954 258.19	4 430 832.81
29	954 252.81	4 431 886.38
30	954 250.51	4 431 666.33
31	954 250.55	4 431 664.13
32	954 252.85	4 431 664.18
33	954 258.67	4 430 916.19
34	954 256.38	4 430 918.19
35	954 256.37	4 430 913.99
36	954 258.66	4 430 913.97
37	954 254.47	4 431 582.99
38	954 252.18	4 431 582.94
39	954 252.22	4 431 580.75
40	954 254.51	4 431 580.79
41	954 256.87	4 430 999.55
42	954 256.85	4 430 997.35
43	954 259.16	4 430 997.33
44	954 259.16	4 430 999.54
45	954 256.15	4 431 499.67
46	954 253.84	4 431 499.62
47	954 253.89	4 431 497.42
48	954 256.19	4 431 497.47
49	954 257.36	4 431 082.92
50	954 257.34	4 431 080.73
51	954 259.65	4 431 080.71
52	954 259.65	4 431 082.91
53	954 257.82	4 431 416.35
54	954 255.52	4 431 416.3
55	954 255.56	4 431 414.1
56	954 257.86	4 431 414.15

Номер	X	Y	Номер	X	Y	Номер	X	Y
60	954 260.3	4 431 161.97	120	954 176.32	4 431 170.54	180	954 253.72	4 432 494.62
61	954 259.48	4 431 333.01	121	954 172.72	4 431 172.49	181	954 253.23	4 432 492.47
62	954 257.18	4 431 332.96	122	954 169	4 431 174.5	182	954 255.47	4 432 491.96
63	954 257.22	4 431 330.76	123	954 167.8	4 431 172.73	183	954 255.97	4 432 494.11
64	954 259.52	4 431 330.8	124	954 162.3	4 431 162.68	184	954 246.15	4 431 999.78
65	954 260.55	4 431 251.53	125	954 186.5	4 431 164.99	185	954 243.85	4 431 999.71
66	954 258.35	4 431 251.49	126	954 181.61	4 431 167.68	186	954 243.99	4 431 997.52
67	954 258.35	4 431 245.41	127	954 183.02	4 431 170.33	187	954 246.19	4 431 997.56
68	954 260.55	4 431 245.46	128	954 190.26	4 431 166.37	188	954 237.14	4 432 424
69	954 205.92	4 431 170.68	129	954 194.43	4 431 165.77	189	954 235.55	4 432 416.91
70	954 205.86	4 431 167.15	130	954 196.61	4 431 166.21	190	954 235.21	4 432 415.39
71	954 210.52	4 431 163.89	131	954 196.12	4 431 168.38	191	954 235.22	4 432 414.54
72	954 212.75	4 431 161.1	132	954 197.34	4 431 168.56	192	954 235.32	4 432 406.82
73	954 214.44	4 431 154.42	133	954 196.45	4 431 172.06	193	954 238.33	4 432 406.66
74	954 216.91	4 431 149.97	134	954 269.74	4 432 594.29	194	954 238.21	4 432 414.27
75	954 219.1	4 431 143.8	135	954 262.67	4 432 578.57	195	954 238.2	4 432 415.21
76	954 219.25	4 431 143.35	136	954 261.82	4 432 575.77	196	954 238.49	4 432 416.47
77	954 224.01	4 431 143.17	137	954 261.28	4 432 575.22	197	954 240.06	4 432 423.32
78	954 224.03	4 431 158.67	138	954 239.69	4 432 482.54	198	954 244.49	4 432 083.11
79	954 222.6	4 431 158.86	139	954 227.9	4 432 427.76	199	954 242.19	4 432 083.06
80	954 222.98	4 431 161.84	140	954 227.26	4 432 424.82	200	954 242.23	4 432 080.86
81	954 224.02	4 431 161.72	141	954 226.8	4 432 424.92	201	954 244.53	4 432 090.91
82	954 224.02	4 431 168.29	142	954 225.29	4 432 360.86	202	954 239.5	4 432 333.15
83	954 207.91	4 431 170.4	143	954 225.12	4 432 353.49	203	954 237.2	4 432 333.1
84	954 209.97	4 431 168.27	144	954 225.2	4 432 348.78	204	954 237.24	4 432 330.9
85	954 208.96	4 431 168.23	145	954 226.07	4 432 279.73	205	954 239.54	4 432 330.95
86	954 208.87	4 431 167.25	146	954 226.83	4 432 205.36	206	954 242.83	4 432 168.45
87	954 209.88	4 431 167.23	147	954 226.84	4 432 204.66	207	954 240.53	4 432 166.41
88	954 188.07	4 431 164.13	148	954 226.88	4 432 202.36	208	954 240.57	4 432 164.21
89	954 161.71	4 431 161.6	149	954 228.15	4 432 130.13	209	954 242.87	4 432 164.26
90	954 160.42	4 431 159.26	150	954 228.81	4 432 055.23	210	954 241.16	4 432 249.8
91	954 183.77	4 431 146.48	151	954 229.43	4 432 031.97	211	954 238.88	4 432 249.75
92	954 206.93	4 431 143.33	152	954 230.43	4 431 994.03	212	954 238.8	4 432 247.55
93	954 207.79	4 431 143.21	153	954 231.04	4 431 922.09	213	954 241.2	4 432 247.59
94	954 205.5	4 431 155.06	154	954 232.41	4 431 847.49	214	954 793.95	4 433 836.41
95	954 201.35	4 431 158.6	155	954 264.67	4 431 831.82	215	954 779.42	4 433 803.27
96	954 200.34	4 431 157.99	156	954 261.24	4 432 032.48	216	954 779.75	4 433 799.99
97	954 199.64	4 431 158.46	157	954 261	4 432 043.65	217	954 675.74	4 433 529.33
98	954 199.25	4 431 161.06	158	954 255.4	4 432 361.43	218	954 671.26	4 433 532.31
99	954 197.81	4 431 160.91	159	954 253.23	4 432 361.48	219	954 662.09	4 433 505.93
100	954 197.5	4 431 162.29	160	954 252.2	4 432 413.03	220	954 664.88	4 433 504.06
101	954 189.06	4 431 163.59	161	954 268.74	4 432 476.36	221	954 660.95	4 433 493.97
102	954 205.66	4 431 166.04	162	954 263.28	4 432 477.15	222	954 661.76	4 433 492.98
103	954 205.67	4 431 165.62	163	954 284.15	4 432 567.65	223	954 614.94	4 433 371.66
104	954 200.42	4 431 166.01	164	954 290.7	4 432 582.63	224	954 606	4 433 375.56
105	954 201.51	4 431 161.27	165	954 278.8	4 432 591.13	225	954 586.62	4 433 332.21
106	954 205.29	4 431 161.96	166	954 274.5	4 432 579.58	226	954 563.1	4 433 278.66
107	954 208.87	4 431 143.42	167	954 271.56	4 432 572.7	227	954 537.18	4 433 217.76
108	954 218.1	4 431 143.46	168	954 271.06	4 432 571.54	228	954 511.39	4 433 160.18
109	954 215.09	4 431 149.34	169	954 270.82	4 432 570.54	229	954 487.06	4 433 104.02
110	954 213.44	4 431 154.18	170	954 269.11	4 432 563.26	230	954 489.67	4 433 102.25
111	954 211.76	4 431 160.7	171	954 272.03	4 432 562.59	231	954 488	4 433 099.76
112	954 209.7	4 431 163.2	172	954 273.67	4 432 569.58	232	954 485.85	4 433 101.21
113	954 180.21	4 431 178.47	173	954 273.94	4 432 570.72	233	954 461.56	4 433 044.34
114	954 179.52	4 431 175.55	174	954 274.35	4 432 571.68	234	954 461.85	4 433 044.24
115	954 171.35	4 431 177.46	175	954 277.24	4 432 578.39	235	954 461.37	4 433 043.05
116	954 171.34	4 431 178.79	176	954 247.82	4 431 916.41	236	954 468.41	4 433 036.93

Перечень координат поворотных точек земельного участка №6:04:000001:110002:33/1

Лист 114 из 134

Номер	X	Y	Номер	X	Y	Номер	X	Y
240	954 395.99	4 432 883.17	300	954 672	4 433 511.18	360	954 626.04	4 433 537.29
241	954 293.94	4 432 649.68	301	954 670.07	4 433 505.4	361	954 627.28	4 433 537.03
242	954 315.61	4 432 639.63	302	954 674.65	4 433 503.93	362	954 628.22	4 433 536.4
243	954 423.98	4 432 887.57	303	954 676.81	4 433 509.61	363	954 633.95	4 433 532.58
244	954 419.4	4 432 889.57	304	954 503.82	4 433 102.5	364	954 635.61	4 433 535.08
245	954 481.24	4 433 031.31	305	954 502.93	4 433 100.48	365	954 629.44	4 433 539.18
246	954 489.48	4 433 027.7	306	954 505.03	4 433 099.56	366	954 628.39	4 433 539.89
247	954 482.22	4 433 026.5	307	954 505.92	4 433 101.58	367	954 627	4 433 540.17
248	954 576.7	4 433 219.05	308	954 642.27	4 433 426.09	368	954 790.76	4 433 864.29
249	954 638.78	4 433 361.26	309	954 641.47	4 433 424.02	369	954 784.52	4 433 849.98
250	954 627.51	4 433 366.17	310	954 643.62	4 433 423.21	370	954 776.61	4 433 831.84
251	954 789.99	4 433 787.65	311	954 644.41	4 433 425.27	371	954 777.23	4 433 825.48
252	954 791.49	4 433 791.57	312	954 539.1	4 433 183.11	372	954 785.49	4 433 843.4
253	954 797.33	4 433 806.76	313	954 538.21	4 433 181.09	373	954 791.63	4 433 856.72
254	954 790.53	4 433 816.32	314	954 540.32	4 433 180.17	374	954 868.58	4 434 350.77
255	954 787.56	4 433 815.9	315	954 541.21	4 433 182.19	375	954 855.37	4 434 348.84
256	954 788.51	4 433 809.11	316	954 610.5	4 433 346.11	376	954 831.38	4 434 076.78
257	954 788.67	4 433 807.95	317	954 608.03	4 433 340.43	377	954 784.05	4 434 051.15
258	954 788.2	4 433 806.72	318	954 610.05	4 433 339.57	378	954 785.03	4 434 049.95
259	954 785.8	4 433 800.39	319	954 612.51	4 433 345.24	379	954 783.26	4 434 048.5
260	954 788.6	4 433 799.32	320	954 574.39	4 433 263.72	380	954 782	4 434 050.04
261	954 791.32	4 433 806.68	321	954 573.5	4 433 261.7	381	954 722.63	4 434 017.9
262	954 791.72	4 433 807.77	322	954 575.6	4 433 260.79	382	954 775.73	4 433 883.43
263	954 791.54	4 433 809.04	323	954 578.49	4 433 262.81	383	954 778.83	4 433 851.92
264	954 365.33	4 432 786.97	324	954 578.09	4 433 262.98	384	954 788.19	4 433 873.37
265	954 363.05	4 432 781.77	325	954 597.13	4 433 562.29	385	954 789.41	4 433 876.18
266	954 358.52	4 432 771.44	326	954 594.14	4 433 559.56	386	954 787.99	4 433 868.61
267	954 330.52	4 432 707.67	327	954 592.44	4 433 548.62	387	954 740.22	4 434 011.5
268	954 323.73	4 432 892.07	328	954 592.61	4 433 548.6	388	954 742.2	4 434 012.57
269	954 320.3	4 432 883.86	329	954 592.35	4 433 547.13	389	954 790.48	4 434 044.96
270	954 323.07	4 432 882.67	330	954 599.61	4 433 545.58	390	954 778.75	4 434 038.79
271	954 326.47	4 432 680.86	331	954 599.01	4 433 542.63	391	954 777.35	4 434 041.3
272	954 333.28	4 432 708.48	332	954 591.74	4 433 544.09	392	954 792.27	4 434 049.44
273	954 361.28	4 432 770.24	333	954 593.58	4 433 543.72	393	954 793.51	4 434 046.99
274	954 365.8	4 432 780.57	334	954 592.42	4 433 538.24	394	954 836.83	4 434 076.05
275	954 368.08	4 432 785.77	335	954 600.25	4 433 535.99	395	954 837.29	4 434 081.06
276	954 758.76	4 433 729.18	336	954 599.43	4 433 533.1	396	954 840.27	4 434 080.78
277	954 757.98	4 433 727.13	337	954 618.85	4 433 531.32	397	954 840	4 434 078.18
278	954 760.13	4 433 726.31	338	954 618.99	4 433 532.32	398	954 845.87	4 434 082.12
279	954 760.91	4 433 728.37	339	954 624.56	4 433 531.49	399	954 850.58	4 434 146.22
280	954 397.95	4 432 860.66	340	954 626.3	4 433 536.53	400	954 859.45	4 434 332.89
281	954 397.07	4 432 858.65	341	954 627.2	4 433 536.21	401	954 858.95	4 434 326.99
282	954 399.18	4 432 857.74	342	954 625.54	4 433 531.35	402	954 858.38	4 434 320.33
283	954 400.06	4 432 859.76	343	954 626.35	4 433 531.23	403	954 858	4 434 315.95
284	954 728.01	4 433 649.16	344	954 626.17	4 433 530	404	954 860.99	4 434 315.7
285	954 727.22	4 433 647.09	345	954 637.65	4 433 522.31	405	954 861.36	4 434 320.02
286	954 729.37	4 433 646.27	346	954 648.32	4 433 533.58	406	954 861.95	4 434 326.78
287	954 730.16	4 433 648.33	347	954 648.21	4 433 538.82	407	954 862.45	4 434 332.62
288	954 433.23	4 432 941.28	348	954 649.31	4 433 545.83	408	954 777.31	4 433 899.9
289	954 432.35	4 432 939.27	349	954 649.3	4 433 545.84	409	954 774.53	4 433 896.78
290	954 434.45	4 432 938.35	350	954 632.49	4 433 553.02	410	954 777.34	4 433 891.79
291	954 435.34	4 432 940.37	351	954 617.55	4 433 554.42	411	954 777.65	4 433 891.02
292	954 697.25	4 433 569.14	352	954 612.34	4 433 560.92	412	954 777.84	4 433 889.65
293	954 696.46	4 433 567.08	353	954 594.59	4 433 542.72	413	954 778.8	4 433 882.77
294	954 698.6	4 433 566.26	354	954 594.37	4 433 540.53	414	954 781.77	4 433 883.17
295	954 889.39	4 433 568.31	355	954 596.66	4 433 540.31	415	954 780.75	4 433 890.35
296	954 468.52	4 433 021.9	356	954 596.75	4 433 541.25	416	954 780.55	4 433 891.73

Перечень координат поворотных точек земельного участка
86:04:0000001:110002:3V1

Номер	X	Y	Номер	X	Y
420	954 853.82	4 434 239	480	954 905.52	4 434 826.35
421	954 854.01	4 434 241.18	481	954 905.44	4 434 825.48
422	954 754.93	4 433 954.59	482	954 903.14	4 434 825.67
423	954 752.8	4 433 953.73	483	954 903.2	4 434 826.28
424	954 753.62	4 433 951.89	484	954 897.43	4 434 826.11
425	954 755.76	4 433 952.56	485	954 888.61	4 434 725.76
426	954 844.34	4 434 157.51	486	954 902.26	4 434 718.05
427	954 844.15	4 434 155.32	487	954 896.01	4 434 744.44
428	954 846.43	4 434 155.13	488	954 895.82	4 434 742.24
429	954 846.63	4 434 157.31	489	954 898.1	4 434 742.04
430	954 736.63	4 434 019.37	490	954 895.3	4 434 744.24
431	954 730.49	4 434 015.97			
432	954 728.16	4 434 014.68			
433	954 729.11	4 434 012.17			
434	954 731.57	4 434 005.69			
435	954 734.36	4 434 006.69			
436	954 731.71	4 434 013.43			
437	954 738.02	4 434 016.87			
438	954 837.83	4 434 088.52			
439	954 837.64	4 434 086.33			
440	954 839.92	4 434 086.15			
441	954 840.12	4 434 088.32			
442	954 855.73	4 434 352.98			
443	954 868.94	4 434 354.89			
444	954 871.75	4 434 386.86			
445	954 893.89	4 434 629.01			
446	954 880.81	4 434 637.35			
447	954 881.25	4 434 576.81			
448	954 881.05	4 434 574.63			
449	954 883.35	4 434 574.42			
450	954 883.53	4 434 576.61			
451	954 866.6	4 434 416.55			
452	954 866.27	4 434 410.36			
453	954 865.68	4 434 403.59			
454	954 865.34	4 434 399.62			
455	954 868.33	4 434 399.35			
456	954 868.68	4 434 403.38			
457	954 869.25	4 434 410.09			
458	954 869.78	4 434 416.28			
459	954 873.87	4 434 492.94			
460	954 873.69	4 434 490.76			
461	954 875.96	4 434 490.55			
462	954 876.16	4 434 492.75			
463	954 885.53	4 434 890.88			
464	954 882.24	4 434 653.5			
465	954 895.48	4 434 645.12			
466	954 896.32	4 434 654.06			
467	954 898.58	4 434 677.94			
468	954 898.86	4 434 680.81			
469	954 899.01	4 434 682.48			
470	954 894.64	4 434 685.3			
471	954 888.98	4 434 684.68			
472	954 888.79	4 434 682.49			
473	954 891.08	4 434 682.29			
474	954 891.27	4 434 684.49			
475	954 887.84	4 434 717.01			
476	954 886.55	4 434 702.36			

Перечень координат поворотных точек земельного участка 86:04:0000001:109988:3V1

Номер	X	Y
1	959 243.3	4 448 691.67
2	959 246.59	4 448 696.25
3	959 234.96	4 448 700.01
4	959 232.1	4 448 697.39
5	959 216.39	4 448 740.24
6	959 215.13	4 448 737.76
7	959 231.34	4 448 726.14
8	959 234.83	4 448 731
9	959 239.68	4 448 727.5
10	959 240.81	4 448 729.56
11	959 243.26	4 448 727.63
12	959 238.88	4 448 722.1
13	959 238.16	4 448 721.2
14	959 242.71	4 448 717.92
15	959 245.41	4 448 723.96
16	959 251.18	4 448 725.5
17	959 255.07	4 448 726.43
18	959 240.73	4 448 731.89
19	959 224.51	4 448 736.25
20	959 269.8	4 448 725.77
21	959 273.9	4 448 730.01
22	959 266.31	4 448 728.15
23	959 283.31	4 448 727.41
24	959 261.29	4 448 727.92
25	959 274.81	4 448 731.26
26	959 289.13	4 448 749.26
27	959 291.67	4 448 754.19
28	959 294.27	4 448 759.04
29	959 299.47	4 448 769.22
30	959 301.38	4 448 768.39
31	959 302.35	4 448 770.45
32	959 303.03	4 448 770.09
33	959 306.5	4 448 776.3
34	959 308.35	4 448 779.84
35	959 292.14	4 448 806.63
36	959 283.47	4 448 819.21
37	959 230.18	4 448 752.26
38	959 224.11	4 448 755.36
39	959 217.75	4 448 742.91
40	959 218.29	4 448 742.69
41	959 225.89	4 448 739.08
42	959 241.13	4 448 734.98
43	959 248.18	4 448 732.43
44	959 255.92	4 448 729.3
45	959 281.78	4 448 780.28
46	959 280.35	4 448 778.42
47	959 282.03	4 448 777.08
48	959 283.44	4 448 778.9
49	959 263.42	4 448 765.78
50	959 283.35	4 448 762.76
51	959 287.37	4 448 762.65
52	959 267.44	4 448 765.63
53	959 311.44	4 448 774.69
54	959 322.26	4 448 795.38
55	959 331.9	4 448 814.49
56	959 340.76	4 448 833.47

Номер	X	Y
60	959 369.82	4 448 913.07
61	959 378.14	4 448 931.58
62	959 404.06	4 448 979.72
63	959 438.47	4 449 043.73
64	959 456.69	4 449 079.33
65	959 497.96	4 449 162.17
66	959 517.33	4 449 202.24
67	959 540.91	4 449 251.32
68	959 588	4 449 355.81
69	959 632.46	4 449 450.1
70	959 681.24	4 449 546.23
71	959 709.2	4 449 609.59
72	959 748.41	4 449 689.16
73	959 777.18	4 449 750.5
74	959 747.81	4 449 779.9
75	959 306.68	4 448 848.37
76	959 284.12	4 448 820.03
77	959 293.02	4 448 807.13
78	959 294.86	4 448 804.08
79	959 297.39	4 448 805.63
80	959 289.44	4 448 802.2
81	959 296.92	4 448 800.65
82	959 309.47	4 448 779.8
83	959 307.62	4 448 776.32
84	959 751	4 449 736.58
85	959 750.94	4 449 733.55
86	959 754.95	4 449 733.44
87	959 755.02	4 449 736.41
88	959 320.77	4 448 829.92
89	959 323.13	4 448 828.07
90	959 331.36	4 448 838.28
91	959 331.49	4 448 844.27
92	959 325.47	4 448 844.46
93	959 325.34	4 448 838.46
94	959 750.29	4 449 731.83
95	959 749.23	4 449 729.76
96	959 751.12	4 449 728.74
97	959 752.18	4 449 730.78
98	959 354.86	4 448 892.39
99	959 354.93	4 448 895.36
100	959 350.92	4 448 895.52
101	959 350.85	4 448 892.49
102	959 729.96	4 448 680.88
103	959 730.03	4 448 683.65

Номер	X	Y	Номер	X	Y	Номер	X	Y
106	959 364 1	4 448 916 37	185	959 479 78	4 448 160 39	224	959 216 01	4 448 725 27
107	959 363 99	4 448 915 36	186	959 481 65	4 448 159 36	225	959 215 33	4 448 723 96
108	959 367 06	4 448 917 36	167	959 482 71	4 448 161 4	226	959 212 02	4 448 736 26
109	959 365 16	4 448 918 44	188	959 480 62	4 448 162 45	227	959 202 16	4 448 712 68
110	959 712 05	4 449 650 53	169	959 604 67	4 449 416 07	228	959 217 54	4 448 732 95
111	959 710 96	4 449 648 46	170	959 605 05	4 449 421 04	229	959 216 52	4 448 730 98
112	959 712 67	4 449 647 44	171	959 601 04	4 449 421 2	230	959 219 14	4 448 729 68
113	959 713 93	4 449 649 47	172	959 600 97	4 449 418 16	231	959 222 05	4 448 726 22
114	959 379 85	4 448 944 97	173	959 504 91	4 449 207 75	232	959 223 01	4 448 730 2
115	959 379 92	4 448 947 94	174	959 504 98	4 449 210 72	233	959 220 23	4 448 731 6
116	959 375 91	4 448 946 04	175	959 500 98	4 449 210 89	234	959 281 34	4 448 716 3
117	959 375 84	4 448 945 06	176	959 500 89	4 449 207 86	235	959 288 01	4 448 720 2
118	959 704 96	4 449 628 32	177	959 596 35	4 449 406 4	236	959 263 71	4 448 722 88
119	959 705 02	4 449 631 29	178	959 595 26	4 449 404 34	237	959 258 21	4 448 725 17
120	959 701 01	4 449 631 45	179	959 597 16	4 449 403 31	238	959 256 53	4 448 725 74
121	959 700 94	4 449 626 43	180	959 596 23	4 448 405 36	239	959 252 2	4 448 724 71
122	959 403 12	4 448 997 57	181	959 518 21	4 449 241 81	240	959 249 81	4 448 726 56
123	959 404 58	4 448 996 78	182	959 520 09	4 449 240 78			
124	959 405 56	4 448 998 52	183	959 521 16	4 448 242 82			
125	959 404 95	4 448 999 21	184	959 519 27	4 449 243 88			
126	959 405 02	4 449 000 51	185	959 519 67	4 449 365 45			
127	959 401	4 449 000 62	186	959 519 94	4 449 366 43			
128	959 400 82	4 448 997 64	187	959 516 04	4 449 368 53			
129	959 679 96	4 449 575 76	188	959 515 86	4 449 365 56			
130	959 680 02	4 449 578 73	189	959 529 89	4 449 260 32			
131	959 676 61	4 448 578 89	190	959 529 96	4 449 263 3			
132	959 675 94	4 449 575 60	191	959 525 95	4 449 263 45			
133	959 429 83	4 449 050 04	192	959 525 88	4 449 260 43			
134	959 430 01	4 449 053 06	193	959 527 78	4 448 325 24			
135	959 425 89	4 448 053 18	194	959 526 71	4 449 323 18			
136	959 425 92	4 449 050 21	195	959 528 59	4 448 322 15			
137	959 673 33	4 449 569 15	196	959 526 67	4 449 324 2			
138	959 672 27	4 449 567 06	197	959 524 69	4 449 312 88			
139	959 674 16	4 449 566 06	198	959 524 96	4 449 315 86			
140	959 675 22	4 449 568 1	199	959 520 94	4 449 316 02			
141	959 441 25	4 449 079 07	200	959 520 87	4 449 312 99			
142	959 443 14	4 449 079 04	201	959 414 79	4 448 978 42			
143	959 444 23	4 449 080 09	202	959 385 96	4 448 921 75			
144	959 442 32	4 449 081 14	203	959 367 20	4 448 862 07			
145	959 634 85	4 449 523 19	204	959 353 3	4 448 852 9			
146	959 635 64	4 449 526 17	205	959 343 77	4 448 833 58			
147	959 651 02	4 449 526 33	206	959 343 54	4 448 826 33			
148	959 650 95	4 449 523 3	207	959 344 36	4 448 818 65			
149	959 454 93	4 449 102 62	208	959 418 25	4 448 977 23			
150	959 459	4 449 105 65	209	959 229 25	4 448 698 65			
151	959 450 98	4 449 105 75	210	959 234 07	4 448 703 26			
152	959 450 82	4 449 102 77	211	959 235 02	4 448 702 19			
153	959 634 8	4 449 487 73	212	959 236 57	4 448 711 54			
154	959 633 71	4 449 485 66	213	959 230 47	4 448 711 17			
155	959 635 61	4 449 484 64	214	959 241 2	4 448 714 76			
156	959 636 69	4 449 486 66	215	959 233 54	4 448 712 76			
157	959 479 91	4 449 155 19	216	959 233 3	4 448 713 67			
158	959 479 98	4 449 158 22	217	959 241 74	4 448 715 96			
159	959 475 97	4 449 156 32	218	959 242 17	4 448 717			
160	959 475 9	4 449 155 29	219	959 237 49	4 448 720 34			
161	959 629 86	4 449 470 63	220	959 228 52	4 448 724 52			
162	959 630 04	4 449 473 6	221	959 228 38	4 448 726 2			

Перечень координат поворотных точек земельного участка №6-04/0000001-10/27-3/1

Номер	X	Y
1	954 161 71	4 431 161 6
2	954 160 42	4 431 159 26
3	954 183 77	4 431 148 48
4	954 206 93	4 431 143 33
5	954 163 74	4 431 141 32
6	954 160 6	4 431 144 18
7	954 159 79	4 431 167 44
8	954 240 47	4 431 187 68
9	954 240 85	4 431 142 94
10	954 233 1	4 431 142 91
11	954 233 02	4 431 145 53
12	954 232 97	4 431 167 12
13	954 233 63	4 431 167 04
14	954 184 55	4 431 176 9
15	954 165 49	4 431 176 69
16	954 164 23	4 431 174 92
17	954 167 6	4 431 172 73
18	954 162 3	4 431 162 68
19	954 159 74	4 431 162 43
20	954 159 57	4 431 166 16
21	954 162 23	4 431 173 86
22	954 226 29	4 432 360 88
23	954 225 12	4 432 353 49
24	954 225 2	4 432 348 78
25	954 226 01	4 432 279 73
26	954 226 83	4 432 205 36
27	954 223 36	4 432 205 42
28	954 223 31	4 432 202 43
29	954 226 88	4 432 202 36
30	954 226 15	4 432 130 13
31	954 226 61	4 432 656 23
32	954 229 43	4 432 631 97
33	954 224 99	4 432 631 91
34	954 219 88	4 432 380 77
35	954 228 53	4 432 656 47
36	954 226 63	4 432 683 48

Номер	X	Y	Номер	X	Y	Номер	X	Y
39	954 227 49	4 432 131 25	98	954 828 83	4 434 084 54	157	954 876 95	4 434 892 13
40	954 227 49	4 432 128 28	99	954 825 85	4 434 078 55	158	954 879 17	4 434 721 91
41	954 223 92	4 432 128 28	100	954 711 31	4 434 020 54	159	954 887 84	4 434 717 02
42	954 223 92	4 432 131 25	101	954 770 82	4 433 880 83	160	954 884 5	4 434 718 63
43	954 222 07	4 432 280 64	102	954 770 18	4 433 851 33	161	954 870 45	4 434 712 41
44	954 225 85	4 432 280 58	103	954 775 38	4 433 844	162	954 865 55	4 434 715 44
45	954 225 6	4 432 277 59	104	954 778 83	4 433 851 92	163	954 865 79	4 434 716 34
46	954 222 03	4 432 277 65	105	954 788 19	4 433 873 37	164	954 872 36	4 434 716 75
47	954 221 31	4 432 354 3	108	954 789 41	4 433 876 18	185	954 938 24	4 435 420 64
48	954 224 88	4 432 354 24	107	954 790 78	4 433 884 29	166	954 945 54	4 435 412 84
49	954 224 84	4 432 351 25	108	954 784 52	4 433 849 98	167	954 921 78	4 435 142 89
50	954 221 26	4 432 351 31	109	954 776 61	4 433 831 84	168	954 925 05	4 435 140 39
51	954 259 4	4 432 361 43	110	954 777 29	4 433 825 48	169	954 939 43	4 435 129 38
52	954 287 87	4 432 361 37	111	954 785 49	4 433 843 4	170	954 938 14	4 435 114 85
53	954 282 98	4 432 032 5	112	954 791 83	4 433 856 72	171	954 923 77	4 435 125 86
54	954 261 24	4 432 032 48	113	954 783 95	4 433 838 41	172	954 920 51	4 435 128 35
55	954 281	4 432 043 65	114	954 779 42	4 433 803 27	173	954 895 89	4 434 826 01
56	954 484 24	4 433 102 3	115	954 779 75	4 433 799 89	174	954 885 23	4 434 727 87
57	954 485 85	4 433 101 21	118	954 875 74	4 433 929 33	175	954 890 32	4 434 730 43
58	954 481 56	4 433 044 34	117	954 871 26	4 433 932 31	176	954 940 65	4 435 418 14
59	954 459 24	4 433 045 2	118	954 882 08	4 433 905 93	177	955 186 21	4 436 068 64
60	954 860 85	4 433 493 87	119	954 884 88	4 433 904 06	178	955 189 76	4 436 066 98
61	954 881 78	4 433 492 86	120	954 853 58	4 433 911 62	179	955 142 87	4 436 052 87
62	954 814 94	4 433 371 88	121	954 859 89	4 433 928 65	180	955 146 15	4 436 062 94
63	954 806	4 433 375 56	122	954 864 65	4 433 940 35	181	955 259 31	4 436 079 03
64	954 886 62	4 433 332 21	123	954 877 08	4 433 935 77	182	955 245 94	4 436 073 58
65	954 863 1	4 433 278 66	124	954 721 2	4 433 880 59	183	955 230 26	4 436 064 59
66	954 537 18	4 433 217 76	125	954 764 08	4 433 782 2	184	955 201 19	4 436 050 9
67	954 511 39	4 433 180 18	126	954 764 71	4 433 782 82	185	955 184	4 436 038 58
68	954 487 06	4 433 184 02	127	954 764 43	4 433 783 11	186	955 192 37	4 436 037 2
69	954 485 45	4 433 185 11	128	954 764 47	4 433 783 2	187	955 190 84	4 436 038 37
70	954 485 41	4 433 105 12	129	954 776 23	4 433 793 81	188	955 188 95	4 436 035 91
71	954 509 32	4 433 159 84	130	954 763 66	4 433 886 95	189	955 190 98	4 436 034 52
72	954 510 75	4 433 158 19	131	954 713 53	4 433 988 29	190	955 192 83	4 436 033 82
73	954 512	4 433 181 82	132	954 709 77	4 434 020 04	191	955 191 9	4 436 030 98
74	954 510 52	4 433 182 6	133	954 725 51	4 434 035 58	192	955 175 35	4 436 028 7
75	954 534 51	4 433 217 5	134	954 737 88	4 434 042 28	193	955 173 29	4 436 022 26
76	954 538 19	4 433 216 74	135	954 775 74	4 434 087 53	194	955 086 15	4 435 750 64
77	954 537 44	4 433 219 47	138	954 773 11	4 434 084 22	195	954 970 16	4 435 423 97
78	954 535 72	4 433 220 26	137	954 817 8	4 434 091 1	196	954 969 38	4 435 417 88
79	954 560 58	4 433 278	138	954 821 37	4 434 095 06	197	954 968 7	4 435 409 7
80	954 582 4	4 433 277 13	139	954 823 98	4 434 099 95	198	954 982 55	4 435 408 18
81	954 583 62	4 433 279 88	140	954 825 09	4 434 103 88	199	954 983 46	4 435 419 14
82	954 581 78	4 433 280 78	141	954 838 44	4 434 231 8	200	954 984 34	4 435 425 75
83	954 583 12	4 433 329 46	142	954 838 44	4 434 231 64	201	955 078 85	4 435 748 07
84	954 583 82	4 433 329 21	143	954 840 28	4 434 343 5	202	955 174 96	4 436 046 93
85	954 584 05	4 433 330 14	144	954 790 8	4 433 835 46	203	955 181 4	4 436 060 54
86	954 584 17	4 433 330 42	145	954 791 7	4 433 835 05	204	955 191 45	4 436 067 68
87	954 585 45	4 433 329 8	146	954 791 27	4 433 834 11	205	955 183 27	4 436 050 31
88	954 586 75	4 433 332 51	147	954 780 37	4 433 834 68	206	955 185 18	4 436 049 05
89	954 584 85	4 433 333 41	148	954 872 98	4 434 642 56	207	955 190 28	4 436 051 42
90	954 887 09	4 433 384 21	149	954 877 32	4 434 639 57	208	955 199 86	4 436 070 58
91	954 616 59	4 433 380 05	150	954 852 52	4 434 358 54	209	955 211 77	4 436 072 2
92	954 781 49	4 433 781 57	151	954 847 38	4 434 355 8	210	955 204 75	4 436 058 05
93	954 793 21	4 433 777 39	152	954 872 94	4 434 698 52	211	955 227 95	4 436 088 98
94	954 781 87	4 433 788 89	153	954 875 71	4 434 696 82	212	955 240 58	4 436 076 27
95	954 789 99	4 433 787 65						

Номер	X	Y	Номер	X	Y	Номер	X	Y
216	956 096 78	4 436 160 83	275	957 369 06	4 437 197 63	334	957 534 4	4 437 519 86
217	956 119 43	4 436 232 19	276	957 371 6	4 437 196 89	335	957 535 87	4 437 525 28
218	956 121 21	4 436 232 06	277	957 368 04	4 437 193 58	336	957 598 25	4 437 504 16
219	956 122 23	4 436 231 21	278	957 369 05	4 437 195 35	337	957 595 01	4 437 481 81
220	956 123 41	4 436 236 51	279	957 348 05	4 437 216 88	338	957 593 82	4 437 491 78
221	956 123 43	4 436 230 41	280	957 354 03	4 437 212 36	339	957 600 32	4 438 141 82
222	956 124 27	4 436 226 78	281	957 354 67	4 437 198 43	340	957 718 36	4 437 705 05
223	956 111 06	4 436 222 37	282	957 357	4 437 193 57	341	957 663 07	4 437 487 63
224	956 103 25	4 436 227 01	283	957 354 74	4 437 192 02	342	957 614 59	4 437 330 21
225	956 111 44	4 436 230 48	284	957 351 95	4 437 198 76	343	957 613 69	4 437 328 83
226	956 091 74	4 436 241 81	285	957 359 13	4 437 201 17	344	957 651 47	4 437 494 58
227	956 097 73	4 436 236 62	286	957 368 02	4 437 218 59	345	957 674 72	4 437 566 24
228	956 067 03	4 436 226 92	287	957 364 82	4 437 204 85	346	957 718 82	4 437 701 57
229	956 065 36	4 436 227 11	288	957 367 18	4 437 200 57	347	957 759 22	4 438 140 35
230	956 064 45	4 436 227 79	289	957 364 44	4 437 198 68	348	957 960 47	4 438 230 19
231	956 065 18	4 436 228 07	290	957 363 59	4 437 200 41	349	957 804 94	4 438 189 09
232	956 094 36	4 436 230 39	291	957 363 03	4 437 212 52	350	957 782 17	4 438 161 46
233	956 063 64	4 436 232 16	292	957 371 55	4 437 230 64	351	957 784 33	4 438 170 26
234	956 091 6	4 436 241 26	293	957 374 41	4 437 225 36	352	957 787 55	4 438 181 74
235	956 090 72	4 436 242 23	294	957 373 57	4 437 223 61	353	957 808 99	4 438 193 64
236	956 077 74	4 436 238 03	295	957 340 91	4 437 222 58	354	957 828 87	4 438 202 52
237	956 077 74	4 436 238 14	296	957 341 52	4 437 225 81	355	957 849 64	4 438 208 67
238	956 119 42	4 436 251 18	297	957 338 5	4 437 226 43	356	957 882 28	4 438 213 74
239	956 119 6	4 436 249 95	298	957 340 16	4 437 228 6	357	957 882 32	4 438 213 75
240	956 119	4 436 249 77	299	957 346 29	4 437 226 14	358	957 893 61	4 438 218 2
241	956 119 24	4 436 248 79	300	957 365 74	4 437 227 5	359	957 929 11	4 438 225 58
242	956 119 87	4 436 248 97	301	957 588 54	4 437 350 82	360	958 053 81	4 438 583 11
243	956 120 41	4 436 249 78	302	957 584 34	4 437 333 72	361	958 071 43	4 438 586 49
244	956 118 87	4 436 244 84	303	957 524 87	4 437 295 2	362	958 071 87	4 438 586 73
245	956 114 34	4 436 242 33	304	957 635 7	4 437 524 54	363	958 074 14	4 438 562 65
246	956 117 78	4 436 250 76	305	957 631 36	4 437 510 78	364	958 079 01	4 438 554 32
247	956 071 72	4 436 304 35	306	957 611 82	4 437 510 25	365	958 080 72	4 438 534 14
248	956 074 53	4 436 303 04	307	957 615 25	4 437 522 11	366	958 075 79	4 438 541 08
249	956 082 77	4 436 288 86	308	957 630 36	4 437 524 45	367	958 088 54	4 438 551 26
250	956 081 13	4 436 285 74	309	957 538 94	4 437 527 87	368	958 082 24	4 438 560 1
251	956 482 88	4 436 664 86	310	957 554 11	4 437 525 78	369	958 050 28	4 438 578 15
252	956 485 7	4 436 659 57	311	957 556 7	4 437 522 81	370	958 172 44	4 438 950 86
253	956 483 96	4 436 658 1	312	957 558 61	4 437 519 19	371	958 178 82	4 438 948 72
254	956 473 09	4 436 658 98	313	957 579 51	4 437 518 21	372	958 180 82	4 438 941 97
255	956 473 95	4 436 660 21	314	957 589 16	4 437 516 91	373	958 186 96	4 438 949 35
256	956 501 44	4 436 756 44	315	957 611	4 437 521 27	374	958 172 56	4 438 982 04
257	956 483 04	4 436 682 8	316	957 601 99	4 437 480 24	375	958 173 28	4 438 965 36
258	956 483 7	4 436 672 99	317	957 581 02	4 437 488 44	376	958 169 72	4 438 982 46
259	956 491 55	4 436 689 26	318	957 538 87	4 437 486 87	377	958 169 8	4 438 958 33
260	956 481 33	4 436 688 71	319	957 532 58	4 437 501 59	378	958 167 94	4 438 957 87
261	956 491 52	4 436 729 48	320	957 533 98	4 437 500 8	379	958 167 58	4 438 960 76
262	956 500 68	4 436 756 28	321	957 540 93	4 437 498 53	380	957 894 94	4 438 279 9
263	957 314 45	4 437 130 4	322	957 541 33	4 437 499 78	381	957 888 97	4 438 276 71
264	957 314 73	4 437 125 4	323	957 590 93	4 437 495 65	382	957 879 36	4 438 272 06
265	957 308 09	4 437 121 16	324	957 590 05	4 437 492 9	383	957 870 17	4 438 277 4
266	957 307 95	4 437 126 21	325	957 566 92	4 437 490 72	384	957 868 02	4 438 278 81
267	957 345 21	4 437 150 24	326	957 567 83	4 437 493 57	385	957 867 69	4 438 277 8
268	957 350 19	4 437 148 04	327	957 581 99	4 437 495 43	386	957 878 93	4 438 278 54
269	957 328 89	4 437 134 91	328	957 581	4 437 491 44	387	957 997 08	4 438 288 52
270	957 326 43	4 437 139 42	329	957 585 18	4 437 491 55	388	957 989 73	4 438 282 76
271	957 396 42	4 437 177 56	330	957 587 54	4 437 499 1	389	957 895 2	4 438 278 61
272	957 357 72	4 437 152 86	331	957 588 48	4 437 502 13			

Перечень координат поворотных точек земельного участка
86:04:0000001:36247:3У3

Номер	X	Y	Номер	X	Y
393	958 003 61	4 439 292 36	452	957 962 96	4 439 315 05
394	957 999	4 439 288 72	453	958 030 54	4 439 318 19
395	958 003 09	4 439 289 07	454	958 023 42	4 439 310 67
396	958 003 61	4 439 292 36	455	958 013 09	4 439 310 16
397	958 002 03	4 439 282 33	456	958 015 40	4 438 315 27
398	957 990 19	4 439 281 86	457	958 017 12	4 439 317 36
399	958 077 89	4 439 295 10	458	958 083 87	4 439 320 81
400	958 099 53	4 439 293 96	459	958 066 42	4 439 307 58
401	958 101 95	4 439 283 66	460	958 079 68	4 439 320 58
402	958 081 05	4 439 292 63	461	958 098 53	4 439 321 54
403	958 079 78	4 439 287 44	462	958 109 98	4 439 310 3
404	958 078 77	4 439 289 51	463	958 112 39	4 439 306 29
405	958 076 08	4 439 288 2	464	958 116 98	4 439 298 42
406	958 076 98	4 439 286 39	465	958 120 22	4 439 291 01
407	958 076	4 439 282 48	466	958 123 54	4 439 273 01
408	958 002 46	4 439 278 76	467	958 124 2	4 439 254 37
409	958 004 07	4 439 289 13	468	958 120 64	4 439 217 24
410	958 034 39	4 439 291 76	469	958 120 49	4 439 284 58
411	958 036 4	4 439 285 71	470	958 114 37	4 439 284 27
412	958 036 86	4 439 281 69	471	958 115 56	4 439 285 17
413	958 033 86	4 439 281 34	472	958 113 78	4 439 287 57
414	958 033 41	4 439 285 36	473	958 112 03	4 439 286 26
415	957 854 75	4 439 295 17	474	958 108 69	4 439 283 99
416	957 853 76	4 439 282 43	475	958 105 93	4 439 283 85
417	957 851 72	4 439 284 62	476	958 103 58	4 439 293 75
418	957 849 7	4 439 285 61	477	958 104 24	4 439 293 71
419	957 845 08	4 439 286 08	478	958 103 41	4 439 296 78
420	957 842 55	4 439 286 62	479	958 101 9	4 439 300 87
421	957 840 8	4 439 289 99	480	958 099 85	4 439 309 48
422	958 157 77	4 439 301 9	481	958 088 94	4 439 321 06
423	958 160 10	4 439 297 03	482	958 107 51	4 439 304 75
424	958 163 8	4 439 171 51	483	958 112 56	4 439 296 13
425	957 917 47	4 439 314 99	484	958 113 82	4 439 293 18
426	957 917 65	4 439 312 64	485	958 110 46	4 439 293 35
427	957 937 5	4 439 313 62	486	958 109 18	4 439 298 28
428	957 937 71	4 439 308 4	487	958 106 96	4 439 304 36
429	957 919 13	4 439 305 47			
430	957 919 04	4 439 307 47			
431	957 902 85	4 439 306 9			
432	957 902 92	4 439 304 88			
433	957 882 3	4 439 303 64			
434	957 855 46	4 439 290 82			
435	957 855 80	4 439 295 69			
436	957 868	4 439 301 36			
437	957 879 53	4 439 310 76			
438	957 899 89	4 439 311 75			
439	957 902 48	4 439 314 35			
440	958 015 11	4 439 317 06			
441	958 014 58	4 439 315 74			
442	958 010 07	4 439 310 01			
443	957 962 43	4 439 307 63			
444	957 962 29	4 439 309 73			
445	957 946 53	4 439 308 85			
446	957 946 82	4 439 306 84			
447	957 940 06	4 439 308 52			
448	957 939 83	4 439 313 72			
449	957 945 06	4 439 313 88			

Перечень координат поворотных точек земельного участка
86:04:0000001:36247:3У3

Номер	X	Y
1	980 885 54	4 444 890 92
2	980 762 06	4 444 549 65
3	980 760 26	4 444 542 19
4	980 682 52	4 444 889 79
5	980 672 2	4 444 951 83
6	980 675 6	4 444 836 6
7	980 671 54	4 444 928 95
8	980 672 26	4 444 935 68
9	980 668 77	4 444 881 31
10	980 696 5	4 444 965 58
11	980 701 78	4 444 931 14
12	980 694 39	4 444 965 25
13	980 668 8	4 444 967 05
14	980 670 89	4 444 957 72
15	980 667 45	4 444 957 19
16	980 665 34	4 444 966 62
17	980 693 16	4 444 970 49
18	980 695 19	4 444 961 45
19	980 693 08	4 444 961 13
20	980 691 08	4 444 970 18
21	980 665 49	4 444 961 65
22	980 665 74	4 444 980 74
23	980 662 28	4 444 980 29
24	980 662 05	4 444 981 31
25	980 689 77	4 444 985 61
26	980 690 89	4 444 984 2
27	980 688 04	4 444 983 89
28	980 687 73	4 444 985 29
29	980 628 05	4 445 084 72
30	980 637 96	4 445 080 9
31	980 648 12	4 445 059 58
32	980 663 09	4 444 992 59
33	980 658 65	4 444 992 05
34	980 652 88	4 445 022 37
35	980 639 33	4 445 071 86
36	980 634 95	4 445 077 73
37	980 628 08	4 445 080 6
38	980 625 66	4 445 083 73
39	980 625 77	4 445 084 43
40	980 626 48	4 445 089 78
41	980 687 37	4 444 996 38
42	980 683 38	4 444 996 93
43	980 664 62	4 445 089 53
44	980 645 3	4 445 097 57
45	980 645 88	4 445 099 09
46	980 631 05	4 445 093 15
47	980 631 18	4 445 093 25
48	980 631 18	4 445 093 26
49	980 633 6	4 445 096 63
50	980 664 8	4 445 100 14
51	980 664 74	4 445 097 57
52	980 649 8	4 445 095 61
53	980 649 21	4 445 098 09
54	980 511 02	4 445 754 31
55	980 515 31	4 445 751 38
56	980 516 18	4 445 745 04

Перечень координат поворотных точек земельного участка 86:04:0060001:3У3

Номер	X	Y	Номер	X	Y
60	980 508.83	4 445 826.82	119	977 267.93	4 449 537.63
61	980 513.2	4 445 795.74	120	977 208.53	4 449 593.36
62	980 510.23	4 445 795.34	121	977 143.62	4 449 627.21
63	980 503.17	4 445 776.03	122	977 063.99	4 449 648.52
64	980 504.6	4 445 783.42	123	976 965.91	4 449 659.58
65	980 510.03	4 445 797.43	124	976 735.67	4 449 684.82
66	980 510.3	4 445 800.2	125	976 597.22	4 449 699.96
67	980 504.12	4 445 844.72	126	976 523.61	4 449 708.02
68	980 508.52	4 445 844.56	127	976 023.51	4 449 756.83
69	980 510.49	4 445 832.82	128	976 023.49	4 449 756.94
70	980 505.75	4 445 832.94	129	975 986.31	4 449 760.92
71	980 498.58	4 445 884.65	130	975 862.7	4 449 773.06
72	980 501.82	4 445 884.5	131	975 831.44	4 449 776.15
73	980 506.49	4 445 856.67	132	975 773.65	4 449 777.68
74	980 502.44	4 445 856.79	133	975 767.47	4 449 774.46
75	980 377.5	4 446 120.13	134	975 737.55	4 449 802.83
76	980 396.92	4 446 102.8	135	975 745.81	4 449 802.33
77	980 393.89	4 446 097.02	136	975 731.41	4 449 785.32
78	980 374.49	4 446 120.33	137	975 728.91	4 449 785.56
79	980 414.36	4 446 160.57	138	975 730.27	4 449 789.66
80	980 423.67	4 446 157.34	139	975 730.47	4 449 791.33
81	980 420.18	4 446 147.25	140	975 732.04	4 449 794.27
82	980 416.22	4 446 155.74	141	975 737.55	4 449 794.27
83	979 787.44	4 446 714.31	142	975 859.84	4 449 810.16
84	980 001.58	4 446 472.8	143	975 869.95	4 449 804.47
85	980 358.57	4 446 070.14	144	975 858.54	4 449 805.66
86	980 453.98	4 445 962.91			
87	980 454.07	4 445 962.8			
88	980 454.01	4 445 962.88			
89	980 481.2	4 445 964.26			
90	980 461.2	4 445 954.27			
91	980 461.77	4 445 953.59			
92	980 461.2	4 445 954.26			
93	980 495.88	4 445 895.79			
94	980 493.12	4 445 895.92			
95	980 458.63	4 445 954.2			
96	980 100.54	4 446 356.65			
97	980 100.54	4 446 356.85			
98	980 013.21	4 446 455.38			
99	980 011.38	4 446 453.77			
100	979 994.59	4 446 472.75			
101	979 783.7	4 446 711			
102	975 770.48	4 449 730.59			
103	975 847.97	4 449 778.62			
104	976 136.48	4 449 748.37			
105	976 525.42	4 449 710.59			
106	976 967.66	4 449 682.07			
107	977 065.84	4 449 651.1			
108	977 145.74	4 449 629.86			
109	977 210.95	4 449 595.57			
110	977 270.51	4 449 539.65			
111	977 284.74	4 449 530.51			
112	977 689.15	4 449 081.23			
113	977 684.08	4 449 075.62			
114	977 683.96	4 449 075.75			
115	977 683.93	4 449 075.78			

Перечень координат поворотных точек земельного участка 86:04:0060001:110003:3У1

Номер	X	Y
1	954 290.7	4 432 582.63
2	954 293.71	4 432 580.48
3	954 286.15	4 432 583.22
4	954 281.41	4 432 540.27
5	954 266.74	4 432 476.36
6	954 263.28	4 432 477.15
7	954 284.15	4 432 567.65
8	954 481.24	4 433 031.31
9	954 489.48	4 433 027.7
10	954 328.48	4 432 659.92
11	954 334.5	4 432 645.79
12	954 332.48	4 432 639.98
13	954 321.49	4 432 636.57
14	954 319.83	4 432 637.68
15	954 315.61	4 432 639.63
16	954 423.98	4 432 867.57
17	954 419.4	4 432 889.57
18	954 789.99	4 433 787.65
19	954 791.87	4 433 768.69
20	954 789.68	4 433 762.93
21	954 638.85	4 433 370.3
22	954 641.55	4 433 369.14
23	954 638.78	4 433 361.26
24	954 627.51	4 433 366.17
25	954 855.37	4 434 348.84
26	954 831.38	4 434 076.76
27	954 784.05	4 434 051.15
28	954 783.65	4 434 051.65
29	954 781.87	4 434 050.19
30	954 782	4 434 050.04
31	954 722.63	4 434 017.9
32	954 775.73	4 433 883.43
33	954 778.83	4 433 851.92
34	954 775.38	4 433 844
35	954 770.16	4 433 851.33
36	954 770.82	4 433 860.83
37	954 711.31	4 434 020.54
38	954 825.85	4 434 078.55
39	954 828.63	4 434 084.54
40	954 841.24	4 434 227.89
41	954 861.43	4 434 344.26
42	954 851.79	4 434 346.32
43	954 877.32	4 434 639.57
44	954 880.81	4 434 637.35
45	954 855.73	4 434 352.98
46	954 852.16	4 434 352.47
47	954 862.52	4 434 356.64
48	954 899.01	4 434 682.46
49	954 904.64	4 434 678.85
50	954 904.49	4 434 677.3
51	954 898.86	4 434 680.81
52	954 875.71	4 434 696.82
53	954 877.32	4 434 695.88
54	954 885.53	4 434 690.86
55	954 882.24	4 434 653.5
56	954 878.73	4 434 655.73
57	954 879.52	4 434 664.7

Номер	X	Y
60	954 887.84	4 434 717.01
61	954 886.55	4 434 702.36
62	954 870.45	4 434 712.41
63	954 897.43	4 434 826.11
64	954 888.61	4 434 725.76
65	954 885.23	4 434 727.67
66	954 893.89	4 434 828.01

Перечень координат поворотных точек земельного участка
№6.04.0090001.109992:3У1

Номер	X	Y	Номер	X	Y
1	954 920.51	4 435 128.35	61	957 360.43	4 437 188.64
2	954 923.77	4 435 125.86	62	957 359.17	4 437 190.23
3	954 897.43	4 434 826.11	63	957 373.57	4 437 223.61
4	954 893.89	4 434 826.01	64	957 366.02	4 437 218.59
5	954 945.54	4 435 412.84	65	957 363.03	4 437 212.52
6	954 948.82	4 435 410.97	66	957 363.59	4 437 200.41
7	954 925.05	4 435 140.39	67	957 364.44	4 437 198.68
8	954 921.78	4 435 142.89	68	957 357	4 437 193.57
9	956 134.33	4 436 189.7	69	957 354.67	4 437 198.43
10	956 137.24	4 436 163.65	70	957 354.03	4 437 212.28
11	956 132.73	4 436 162.36	71	957 348.05	4 437 216.98
12	956 119.13	4 436 172.25	72	957 342.39	4 437 221.42
13	956 088.02	4 436 180.85	73	957 340.91	4 437 222.58
14	956 447.81	4 436 492.21	74	957 997.17	4 438 220.26
15	956 441.8	4 436 488.26	75	957 975.22	4 438 204.38
16	956 422.2	4 436 393.74	76	957 821.89	4 438 166.64
17	956 418.31	4 436 394.46	77	957 820.19	4 438 164.41
18	956 438.18	4 436 489.41	78	957 800.32	4 438 141.62
19	956 442.4	4 436 509.56	79	957 799.22	4 438 140.35
20	956 451.9	4 436 507.65	80	957 716.82	4 437 701.57
21	956 450.64	4 436 501.41	81	957 674.72	4 437 588.24
22	956 440.06	4 436 498.34	82	957 651.47	4 437 494.58
23	956 467.69	4 436 586.03	83	957 613.69	4 437 328.83
24	956 465.83	4 436 577.15	84	957 606.5	4 437 317.75
25	956 456.95	4 436 579	85	957 603.07	4 437 314.67
26	956 457.7	4 436 582.61	86	957 445.81	4 437 209.51
27	956 483.96	4 436 658.1	87	957 396.42	4 437 177.56
28	956 474.64	4 436 648.65	88	957 385.47	4 437 176.28
29	956 464.01	4 436 597.81	89	957 605.37	4 437 318.76
30	956 465.36	4 436 591.58	90	957 646.81	4 437 499.92
31	956 459.12	4 436 589.45	91	957 711.98	4 437 706.66
32	956 473.06	4 436 655.98	92	957 752.89	4 437 927.39
33	956 500.68	4 436 756.28	93	957 757.81	4 437 926.47
34	956 491.52	4 436 729.46	94	957 777.92	4 438 033.48
35	956 481.33	4 436 680.71	95	957 773.99	4 438 034.23
36	956 481.55	4 436 669.25	96	957 794.55	4 438 145.01
37	956 491.1	4 436 668.48	97	957 816.28	4 438 171.4
38	956 475.66	4 436 688.39	98	958 068.54	4 438 551.26
39	956 489.31	4 436 733.64	99	958 075.79	4 438 541.08
40	956 496.77	4 436 755.49	100	958 080.72	4 438 534.14
41	956 698.55	4 436 845.44	101	958 080.64	4 438 533.52
42	956 699.82	4 436 838.56	102	958 065.52	4 438 525.67
43	956 683.01	4 436 835.61	103	958 021.97	4 438 324.52
44	956 682.69	4 436 837.25	104	958 015.16	4 438 326.14
45	956 527.01	4 436 808.32	105	958 166.96	4 438 949.35
46	956 520.06	4 436 804	106	958 180.92	4 438 941.97
47	956 514.83	4 436 797.72	107	958 181.36	4 438 925.87
48	956 502.92	4 436 762.85	108	958 160.14	4 438 925.21
49	956 499.02	4 436 762.06	109	958 074.14	4 438 562.85
50	956 515.74	4 436 811.07	110	958 071.97	4 438 565.73
51	957 281.71	4 437 109.95	111	958 162.66	4 438 948.17
52	957 281.8	4 437 104.26			
53	957 241.23	4 437 079.55			
54	957 238.59	4 437 083.81			
55	957 302.08	4 437 122.43			
56	957 302.48	4 437 109.89			
57	957 295.16	4 437 105.47			

Перечень координат поворотных точек земельного участка
№6.04.0090001:3У3

Номер	X	Y
1	959 311.44	4 448 774.69
2	959 344.36	4 448 818.65
3	959 343.54	4 448 826.33
4	959 343.77	4 448 833.58
5	959 353.3	4 448 852.9
6	959 367.26	4 448 882.07
7	959 385.96	4 448 921.75
8	959 414.79	4 448 978.42
9	959 464.34	4 449 081.6
10	959 502.23	4 449 159.75
11	959 543.99	4 449 247.1
12	959 594.87	4 449 351.75
13	959 639.75	4 449 447.07
14	959 684.66	4 449 540.88
15	959 714.84	4 449 604.65
16	959 737.74	4 449 655.01
17	959 753.76	4 449 687.1
18	959 776.75	4 449 733.87
19	959 781.77	4 449 745.9
20	959 777.16	4 449 750.5
21	959 748.41	4 449 689.16
22	959 709.2	4 449 609.59
23	959 681.24	4 449 546.23
24	959 632.46	4 449 450.1
25	959 588	4 449 355.81
26	959 540.91	4 449 251.32
27	959 517.33	4 449 202.24
28	959 497.96	4 449 162.17
29	959 456.69	4 449 079.33
30	959 436.47	4 449 043.73
31	959 404.06	4 448 979.72
32	959 378.14	4 448 931.58
33	959 369.82	4 448 913.07
34	959 353.92	4 448 879.92
35	959 340.16	4 448 851.9
36	959 339.41	4 448 844.79
37	959 340.76	4 448 833.47
38	959 331.9	4 448 814.49
39	959 322.26	4 448 795.38

Номер	X	Y	Номер	X	Y	Номер	X	Y
1	980 763.47	4 444 622.09	61	980 577.89	4 445 436.8	121	980 343.85	4 446 110.76
2	980 767.49	4 444 621.95	62	980 581.09	4 445 436.71	122	980 347.66	4 446 110.66
3	980 767.31	4 444 618.99	63	980 581.02	4 445 433.7	123	980 347.59	4 446 107.65
4	980 763.41	4 444 619.09	64	980 578.41	4 445 433.78	124	980 343.58	4 446 107.75
5	980 750.92	4 444 676.33	65	980 569.27	4 445 484.07	125	980 309.28	4 446 149.4
6	980 754.93	4 444 676.17	66	980 573.29	4 445 493.92	126	980 313.29	4 446 149.3
7	980 754.87	4 444 673.22	67	980 573.22	4 445 490.91	127	980 313.23	4 446 146.29
8	980 750.85	4 444 673.31	68	980 569.21	4 445 491.06	128	980 309.22	4 446 146.39
9	980 738.47	4 444 730.55	69	980 561.62	4 445 549.5	129	980 268.68	4 446 194.94
10	980 742.49	4 444 730.4	70	980 565.63	4 445 549.4	130	980 272.71	4 446 194.84
11	980 742.42	4 444 727.44	71	980 565.57	4 445 546.39	131	980 272.64	4 446 191.83
12	980 738.4	4 444 727.54	72	980 561.55	4 445 546.49	132	980 268.62	4 446 191.97
13	980 726.01	4 444 785.74	73	980 554.07	4 445 604.99	133	980 226.09	4 446 240.6
14	980 730.02	4 444 785.64	74	980 558.09	4 445 604.84	134	980 232.11	4 446 240.42
15	980 729.85	4 444 782.63	75	980 558.02	4 445 601.83	135	980 232.04	4 446 237.41
16	980 725.94	4 444 782.73	76	980 554.01	4 445 601.99	136	980 226.02	4 446 237.58
17	980 713.57	4 444 839.97	77	980 546.29	4 445 660.42	137	980 189.76	4 446 283.56
18	980 717.58	4 444 839.87	78	980 550.2	4 445 660.32	138	980 193.78	4 446 283.46
19	980 717.52	4 444 836.86	79	980 550.22	4 445 658.66	139	980 193.6	4 446 280.45
20	980 713.5	4 444 836.96	80	980 550.24	4 445 657.31	140	980 189.59	4 446 280.55
21	980 701.24	4 444 894.25	81	980 546.23	4 445 657.41	141	980 151.66	4 446 326.29
22	980 705.14	4 444 894.1	82	980 538.86	4 445 715.86	142	980 155.67	4 446 326.19
23	980 705.08	4 444 891.09	83	980 542.86	4 445 715.76	143	980 155.5	4 446 323.18
24	980 701.06	4 444 891.24	84	980 542.81	4 445 712.76	144	980 151.48	4 446 323.28
25	980 688.79	4 444 948.59	85	980 538.8	4 445 712.86	145	980 113.08	4 446 369.35
26	980 692.69	4 444 948.49	86	980 531.32	4 445 771.35	146	980 117.23	4 446 369.23
27	980 692.62	4 444 945.47	87	980 535.33	4 445 771.2	147	980 117.17	4 446 366.22
28	980 688.61	4 444 945.57	88	980 535.27	4 445 768.19	148	980 113.54	4 446 366.33
29	980 676.35	4 445 002.86	89	980 531.26	4 445 768.34	149	980 112.93	4 446 366.35
30	980 680.36	4 445 002.72	90	980 522.64	4 445 835.53	150	980 114.53	4 446 367.84
31	980 680.3	4 444 999.71	91	980 526.65	4 445 835.37	151	980 111.21	4 446 369.41
32	980 676.28	4 444 999.85	92	980 526.59	4 445 832.4	152	980 112.92	4 446 369.36
33	980 663.91	4 445 057.1	93	980 522.58	4 445 832.46	153	980 111.35	4 446 367.9
34	980 667.92	4 445 057	94	980 522.58	4 445 832.5	154	980 112.78	4 446 366.35
35	980 667.86	4 445 053.99	95	980 512.96	4 445 899.89	155	980 111.15	4 446 366.4
36	980 663.85	4 445 054.08	96	980 518.87	4 445 899.67	156	980 075.78	4 446 412.44
37	980 651.59	4 445 111.33	97	980 518.94	4 445 894.98	157	980 079.79	4 446 412.35
38	980 655.49	4 445 111.23	98	980 514.37	4 445 894.93	158	980 079.73	4 446 409.33
39	980 655.42	4 445 108.22	99	980 512.92	4 445 895.02	159	980 075.71	4 446 409.43
40	980 651.41	4 445 108.32	100	980 512.94	4 445 897.29	160	980 038.35	4 446 455.56
41	980 639.14	4 445 165.61	101	980 493.08	4 445 930.87	161	980 042.36	4 446 455.46
42	980 643.15	4 445 165.46	102	980 497.09	4 445 930.77	162	980 042.3	4 446 452.45
43	980 642.98	4 445 162.44	103	980 496.92	4 445 927.76	163	980 038.28	4 446 452.54
44	980 639.07	4 445 162.6	104	980 493.02	4 445 927.86	164	980 000.91	4 446 498.72
45	980 626.7	4 445 219.84	105	980 469.88	4 445 967.21	165	980 004.92	4 446 498.62
46	980 630.72	4 445 219.74	106	980 475.7	4 445 967.02	166	980 004.86	4 446 495.61
47	980 630.65	4 445 216.73	107	980 475.63	4 445 964.01	167	980 000.85	4 446 495.71
48	980 626.64	4 445 216.83	108	980 472.75	4 445 964.09	168	979 963.47	4 446 541.84
49	980 614.27	4 445 274.07	109	980 473.06	4 445 964.38	169	979 967.49	4 446 541.74
50	980 618.28	4 445 273.97	110	980 471.48	4 445 965.89	170	979 967.42	4 446 538.73
51	980 618.22	4 445 270.96	111	980 469.61	4 445 964.18	171	979 963.41	4 446 538.83
52	980 614.2	4 445 271.06	112	980 469.61	4 445 964.19	172	979 926.04	4 446 584.95
53	980 601.95	4 445 328.3	113	980 425.08	4 446 019.33	173	979 930.05	4 446 584.85
54	980 605.96	4 445 328.2	114	980 429.09	4 446 019.01	174	979 929.98	4 446 581.84
55	980 605.78	4 445 325.19	115	980 428.8	4 446 016.06	175	979 925.97	4 446 581.95
56	980 601.77	4 445 325.34	116	980 424.9	4 446 016.37	176	979 888.6	4 446 628.07
57	980 589.5	4 445 382.58	117	980 383.46	4 446 065.97	177	979 892.61	4 446 627.97

Номер	X	Y	Номер	X	Y	Номер	X	Y
181	979 855.19	4 446 671.09	241	979 364.48	4 447 223.05	301	978 837.58	4 447 809.73
182	979 855.12	4 446 668.08	242	979 364.3	4 447 220.04	302	978 835.45	4 447 809.78
183	979 849.09	4 446 668.26	243	979 360.29	4 447 220.15	303	978 836.42	4 447 810.7
184	979 812.97	4 446 713.44	244	979 323.71	4 447 265.97	304	978 834.88	4 447 812.26
185	979 816.98	4 446 713.34	245	979 327.73	4 447 265.87	305	978 833.6	4 447 811.07
186	979 816.92	4 446 710.33	246	979 327.66	4 447 262.86	306	978 808.7	4 447 840.64
187	979 812.9	4 446 710.48	247	979 323.65	4 447 263.02	307	978 814.61	4 447 840.46
188	979 774.77	4 446 755.75	248	979 284.95	4 447 308.93	308	978 814.56	4 447 836.48
189	979 778.78	4 446 755.59	249	979 290.98	4 447 308.75	309	978 808.54	4 447 836.61
190	979 778.72	4 446 752.84	250	979 290.91	4 447 305.73	310	978 768.7	4 447 885.15
191	979 774.7	4 446 752.74	251	979 284.88	4 447 305.92	311	978 774.71	4 447 885.13
192	979 736.57	4 446 797.99	252	979 248.43	4 447 351.43	312	978 774.66	4 447 881.15
193	979 740.58	4 446 797.89	253	979 252.45	4 447 351.33	313	978 768.78	4 447 881.11
194	979 740.51	4 446 794.88	254	979 252.38	4 447 348.32	314	978 744.56	4 447 912.36
195	979 736.5	4 446 795.04	255	979 248.37	4 447 348.42	315	978 748.57	4 447 912.26
196	979 698.48	4 446 840.3	256	979 210.01	4 447 394.12	316	978 748.51	4 447 909.25
197	979 702.38	4 446 840.14	257	979 214.02	4 447 394.02	317	978 744.49	4 447 908.35
198	979 702.31	4 446 837.18	258	979 213.85	4 447 391.01	318	978 714.64	4 447 945.94
199	979 698.3	4 446 837.29	259	979 209.94	4 447 391.16	319	978 718.54	4 447 945.84
200	979 660.28	4 446 882.55	260	979 171.37	4 447 436.64	320	978 718.47	4 447 942.83
201	979 664.3	4 446 882.45	261	979 175.38	4 447 436.54	321	978 714.46	4 447 942.93
202	979 664.12	4 446 879.44	262	979 175.31	4 447 433.53	322	978 682.6	4 447 979.6
203	979 660.64	4 446 879.57	263	979 171.3	4 447 433.63	323	978 688.62	4 447 979.42
204	979 661.07	4 446 879.97	264	979 130.83	4 447 479.3	324	978 688.56	4 447 976.41
205	979 660.18	4 446 880.87	265	979 136.85	4 447 479.13	325	978 682.54	4 447 976.59
206	979 621.97	4 446 924.91	266	979 136.78	4 447 478.12	326	978 647.54	4 448 021.87
207	979 625.99	4 446 924.81	267	979 133.83	4 447 476.21	327	978 651.55	4 448 021.77
208	979 625.92	4 446 921.8	268	979 132.89	4 447 477.44	328	978 651.48	4 448 018.76
209	979 621.91	4 446 921.9	269	979 131.38	4 447 476.27	329	978 647.47	4 448 018.92
210	979 583.77	4 446 967.17	270	979 130.76	4 447 476.29	330	978 610.58	4 448 064.27
211	979 587.79	4 446 967.06	271	979 096.43	4 447 521.52	331	978 614.59	4 448 064.12
212	979 587.72	4 446 964.05	272	979 100.44	4 447 521.42	332	978 614.41	4 448 061.16
213	979 583.71	4 446 964.21	273	979 100.37	4 447 518.41	333	978 610.4	4 448 061.26
214	979 545.58	4 447 009.47	274	979 096.36	4 447 518.51	334	978 573.39	4 448 106.67
215	979 549.59	4 447 009.31	275	979 060.14	4 447 563.81	335	978 577.4	4 448 106.57
216	979 549.52	4 447 006.36	276	979 064.15	4 447 563.71	336	978 577.34	4 448 103.56
217	979 545.51	4 447 006.48	277	979 064.08	4 447 560.7	337	978 573.32	4 448 103.66
218	979 509.46	4 447 051.68	278	979 060.07	4 447 560.8	338	978 536.43	4 448 149.03
219	979 511.39	4 447 051.62	279	979 021.72	4 447 606.18	339	978 540.44	4 448 148.93
220	979 511.32	4 447 048.61	280	979 027.74	4 447 606.01	340	978 540.27	4 448 145.91
221	979 509.96	4 447 048.65	281	979 027.68	4 447 603	341	978 536.25	4 448 146.06
222	979 511.27	4 447 049.78	282	979 021.66	4 447 603.17	342	978 499.37	4 448 191.43
223	979 505.41	4 447 051.8	283	978 982.04	4 447 651.22	343	978 503.38	4 448 191.27
224	979 505.72	4 447 051.79	284	978 986.05	4 447 651.12	344	978 503.31	4 448 188.32
225	979 508.47	4 447 048.69	285	978 985.88	4 447 648.11	345	978 499.3	4 448 188.42
226	979 505.3	4 447 048.79	286	978 981.86	4 447 648.21	346	978 460.29	4 448 233.86
227	979 505.37	4 447 051.8	287	978 940.24	4 447 696.35	347	978 466.31	4 448 233.68
228	979 470.62	4 447 094.59	288	978 944.26	4 447 696.19	348	978 466.24	4 448 230.67
229	979 474.63	4 447 094.45	289	978 944.19	4 447 693.23	349	978 466.22	4 448 230.85
230	979 474.57	4 447 091.43	290	978 940.18	4 447 693.34	350	978 423.67	4 448 275.89
231	979 470.55	4 447 091.58	291	978 898.56	4 447 741.46	351	978 427.57	4 448 275.73
232	979 433.98	4 447 137.42	292	978 902.57	4 447 741.36	352	978 427.51	4 448 272.78
233	979 438	4 447 137.32	293	978 902.39	4 447 738.35	353	978 423.49	4 448 272.88
234	979 437.82	4 447 134.3	294	978 898.49	4 447 738.45	354	978 384.93	4 448 318.01
235	979 433.92	4 447 134.41	295	978 855.42	4 447 786.62	355	978 388.95	4 448 317.86
236	979 397.11	4 447 180.28	296	978 860.77	4 447 786.48	356	978 388.88	4 448 314.89
237	979 401.13	4 447 180.18	297	978 860.71	4 447 783.47	357	978 384.87	4 448 314.99

Номер	X	Y	Номер	X	Y	Номер	X	Y
361	978 346.13	4 448 357.11	421	977 942.03	4 448 813.17	481	959 479.98	4 449 158.22
362	978 307.58	4 448 402.19	422	977 938.02	4 448 813.27	482	959 479.91	4 449 155.19
363	978 311.6	4 448 402.08	423	959 325.47	4 448 844.46	483	959 475.9	4 449 155.29
364	978 311.42	4 448 399.07	424	959 331.49	4 448 844.27	484	977 626.95	4 449 166.9
365	978 307.52	4 448 399.23	425	959 331.35	4 448 838.28	485	977 630.97	4 449 166.79
366	978 270.6	4 448 444.16	426	959 325.34	4 448 838.48	486	977 630.70	4 449 163.78
367	978 275.09	4 448 444.02	427	977 897.31	4 448 861.55	487	977 626.89	4 449 163.93
368	978 275.02	4 448 441.06	428	977 901.32	4 448 861.45	488	977 596.5	4 449 205.61
369	978 272.8	4 448 441.12	429	977 901.25	4 448 858.44	489	977 596.2	4 449 205.57
370	978 273.24	4 448 441.36	430	977 897.24	4 448 858.54	490	977 598.13	4 449 202.56
371	978 236.39	4 448 483.5	431	959 350.92	4 448 895.52	491	977 594.11	4 449 202.66
372	978 240.3	4 448 483.39	432	959 354.93	4 448 895.36	492	977 594.16	4 449 204.88
373	978 240.23	4 448 480.38	433	959 354.86	4 448 892.39	493	977 595.13	4 449 203.61
374	978 236.22	4 448 480.49	434	959 350.85	4 448 892.49	494	977 596.96	4 449 205.05
375	978 201.82	4 448 522.78	435	977 856.64	4 448 906.76	495	959 500.96	4 449 210.89
376	978 207.84	4 448 522.59	436	977 860.65	4 448 906.88	496	959 504.98	4 449 210.72
377	978 207.78	4 448 519.58	437	977 860.58	4 448 903.85	497	959 504.91	4 449 207.75
378	978 201.76	4 448 519.76	438	977 856.57	4 448 903.75	498	959 500.89	4 449 207.86
379	978 167.93	4 448 562.12	439	959 375.91	4 448 948.04	499	977 561.53	4 449 244.4
380	978 171.94	4 448 562.02	440	959 379.92	4 448 947.94	500	977 565.55	4 449 244.29
381	978 171.88	4 448 559	441	959 378.85	4 448 944.97	501	977 565.48	4 449 241.28
382	978 167.86	4 448 559.15	442	959 375.84	4 448 945.06	502	977 561.46	4 449 241.44
383	978 132.13	4 448 601.59	443	977 816.86	4 448 952.04	503	959 525.95	4 449 283.45
384	978 136.15	4 448 601.49	444	977 819.87	4 448 951.94	504	959 529.96	4 449 263.3
385	978 135.97	4 448 598.47	445	977 819.8	4 448 948.92	505	959 529.89	4 449 280.32
386	978 131.96	4 448 598.58	446	977 815.79	4 448 949.02	506	959 525.88	4 449 260.43
387	978 096.23	4 448 641.01	447	977 775.19	4 448 997.31	507	977 521.08	4 449 290.06
388	978 100.24	4 448 640.91	448	977 779.09	4 448 997.2	508	977 527.1	4 449 289.88
389	978 100.17	4 448 637.89	449	977 779.02	4 448 994.19	509	977 527.04	4 449 286.87
390	978 096.16	4 448 638.05	450	977 775.01	4 448 994.3	510	977 521.02	4 449 287.05
391	978 058.31	4 448 680.58	451	959 401	4 449 000.62	511	959 550.94	4 449 316.02
392	978 064.33	4 448 680.38	452	959 405.02	4 449 000.51	512	959 554.96	4 449 315.86
393	978 064.26	4 448 677.37	453	959 404.94	4 448 999.22	513	959 554.89	4 449 312.88
394	978 061.06	4 448 677.47	454	959 404.89	4 448 999.25	514	959 550.87	4 449 312.99
395	978 060.67	4 448 677.47	455	959 403.71	4 448 999.9	515	977 486.12	4 449 326.07
396	978 058.24	4 448 677.55	456	959 402.65	4 448 997.84	516	977 492.14	4 449 325.88
397	978 019.53	4 448 725.75	457	959 403.12	4 448 997.58	517	977 492.08	4 449 322.87
398	978 023.55	4 448 725.65	458	959 400.82	4 448 997.64	518	977 490.62	4 449 322.91
399	978 023.48	4 448 722.63	459	977 734.41	4 449 042.58	519	977 489.32	4 449 322.96
400	978 019.47	4 448 722.74	460	977 738.42	4 449 042.47	520	977 486.06	4 449 323.05
401	959 234.83	4 448 731	461	977 738.35	4 449 039.46	521	959 576.04	4 449 368.63
402	959 239.68	4 448 727.5	462	977 734.34	4 449 039.57	522	959 578.94	4 449 368.43
403	959 236.18	4 448 722.64	463	959 425.99	4 449 053.18	523	959 579.87	4 449 368.45
404	959 231.34	4 448 726.14	464	959 430.01	4 449 053.08	524	959 575.86	4 449 365.56
405	959 263.42	4 448 765.78	465	959 429.83	4 449 050.04	525	977 446.58	4 449 371.2
406	959 267.44	4 448 765.63	466	959 425.92	4 449 050.21	526	977 450.59	4 449 371.04
407	959 287.37	4 448 762.65	467	977 691.62	4 449 087.93	527	977 450.52	4 449 368.08
408	959 263.35	4 448 762.76	468	977 697.64	4 449 087.75	528	977 446.51	4 449 368.19
409	977 978.86	4 448 771.01	469	977 696.25	4 449 086.08	529	977 405.13	4 449 416.36
410	977 982.88	4 448 770.91	470	977 697.57	4 449 084.73	530	977 409.04	4 449 416.26
411	977 982.7	4 448 767.9	471	977 691.55	4 449 084.91	531	977 408.97	4 449 413.24
412	977 978.79	4 448 768	472	959 450.98	4 449 105.75	532	977 404.96	4 449 413.34
413	959 297.39	4 448 805.63	473	959 455	4 449 105.65	533	959 601.04	4 449 421.2
414	959 299.44	4 448 802.2	474	959 454.93	4 449 102.62	534	959 605.05	4 449 421.04
415	959 296.92	4 448 800.65	475	959 450.92	4 449 102.77	535	959 604.87	4 449 418.07
416	959 296.92	4 448 800.64	476	977 659.5	4 449 128.27	536	959 600.97	4 449 418.18
417	959 295.1	4 448 803.67	477	977 663.52	4 449 128.17	537	977 363.58	4 449 461.58

Перечень координат поворотных точек земельного участка
86-04-0000001:32239-3У1

Номер	X	Y	Номер	X	Y
541	959 626.02	4 449 473.77	601	976 593.48	4 449 718.79
542	959 630.04	4 449 473.6	602	976 589.44	4 449 719.21
543	959 629.86	4 449 470.63	603	976 531.36	4 449 728.28
544	959 625.96	4 449 470.74	604	976 537.38	4 449 728.14
545	977 322.03	4 449 506.74	605	976 537.31	4 449 725.13
546	977 326.05	4 449 506.63	606	976 531.29	4 449 725.31
547	977 325.98	4 449 503.62	607	976 531.31	4 449 726.13
548	977 321.96	4 449 503.78	608	976 473.31	4 449 734.49
549	959 651.02	4 449 526.33	609	976 477.33	4 449 734.33
550	959 655.04	4 449 526.17	610	976 477.26	4 449 731.37
551	959 654.85	4 449 523.19	611	976 473.25	4 449 731.48
552	959 650.95	4 449 523.3	612	959 751	4 449 736.57
553	977 279.33	4 449 552.01	613	959 755.02	4 449 736.41
554	977 284.5	4 449 551.86	614	959 754.95	4 449 733.44
555	977 284.43	4 449 548.85	615	959 750.94	4 449 733.55
556	977 282.38	4 449 548.9	616	976 413.27	4 449 740.63
557	977 282.46	4 449 548.99	617	976 417.17	4 449 740.52
558	959 676.01	4 449 578.89	618	976 417.1	4 449 737.51
559	959 680.02	4 449 578.73	619	976 413.09	4 449 737.66
560	959 679.96	4 449 575.76	620	976 110.76	4 449 766.73
561	959 675.94	4 449 575.86	621	976 116.68	4 449 766.06
562	977 249.76	4 449 580.39	622	976 118.39	4 449 763.11
563	977 253.77	4 449 580.29	623	976 110.47	4 449 763.78
564	977 253.71	4 449 577.28	624	976 110.76	4 449 766.72
565	977 249.69	4 449 577.44	625	976 051.59	4 449 773.37
566	977 218.58	4 449 609.3	626	976 055.61	4 449 772.91
567	977 224.49	4 449 609.07	627	976 055.21	4 449 769.98
568	977 224.44	4 449 605.09	628	976 051.3	4 449 770.41
569	977 218.42	4 449 605.22	629	975 990.53	4 449 780.24
570	977 218.46	4 449 606.15	630	975 994.44	4 449 779.8
571	977 219.79	4 449 605.54	631	975 994.26	4 449 777.98
572	977 220.77	4 449 607.65	632	975 990.27	4 449 778.36
573	977 218.73	4 449 608.54	633	975 929.37	4 449 787.12
574	977 218.53	4 449 608.11	634	975 933.38	4 449 786.66
575	977 185.92	4 449 625.94	635	975 933.09	4 449 783.68
576	977 189.93	4 449 625.84	636	975 929.07	4 449 784.16
577	977 189.75	4 449 622.83	637	975 929.37	4 449 787.11
578	977 185.74	4 449 622.98	638	975 866.08	4 449 793.54
579	959 701.01	4 449 631.45	639	975 872.1	4 449 793.35
580	959 705.02	4 449 631.29	640	975 872.03	4 449 790.34
581	959 704.96	4 449 628.32	641	975 866.01	4 449 790.53
582	959 700.94	4 449 628.43	642	975 808.29	4 449 797.88
583	977 153.22	4 449 644.51	643	975 812.3	4 449 797.77
584	977 158.72	4 449 641.9	644	975 812.23	4 449 794.76
585	977 156.99	4 449 638.33	645	975 808.22	4 449 794.86
586	977 151.49	4 449 640.88	646	975 747.15	4 449 802.25
587	976 967.44	4 449 682.67	647	975 753.06	4 449 801.88
588	976 973.47	4 449 682.27	648	975 752.7	4 449 795.9
589	976 973.18	4 449 679.17			
590	976 967.26	4 449 679.78			
591	959 726	4 449 684.01			
592	959 730.03	4 449 683.85			
593	959 729.96	4 449 680.88			
594	959 725.93	4 449 680.98			
595	976 645.67	4 449 715.23			
596	976 649.57	4 449 715.07			
597	976 649.49	4 449 712.94			

Перечень координат поворотных точек
земельного участка
86-04-0000001:109983-3У1

Лист 125 из 134

Номер	X	Y
1	980 674.59	4 444 952.19
2	980 680.31	4 444 926.42
3	980 677.71	4 444 925.88
4	980 681.77	4 444 907.75
5	980 672.88	4 444 916.62
6	980 669.67	4 444 917.79
7	980 683.34	4 444 920.11
8	980 662.6	4 444 925.17
9	980 671.54	4 444 928.95
10	980 675.6	4 444 936.6
11	980 672.2	4 444 951.83
12	980 671.23	4 444 967.34
13	980 673.29	4 444 958.1
14	980 670.89	4 444 957.72
15	980 668.8	4 444 967.05
16	980 667.93	4 444 982.23
17	980 668.19	4 444 981.06
18	980 665.74	4 444 980.74
19	980 665.49	4 444 981.85
20	980 644.73	4 445 086.92
21	980 665.55	4 444 992.97
22	980 663.09	4 444 992.59
23	980 648.12	4 445 059.58
24	980 637.96	4 445 080.9
25	980 628.05	4 445 084.72
26	980 510.23	4 445 795.34
27	980 515.03	4 445 760.53
28	980 497.35	4 445 760.15
29	980 503.18	4 445 776.09
30	975 780.31	4 449 780.85
31	975 770.48	4 449 780.59
32	975 787.47	4 449 774.48
33	975 760.9	4 449 761.1
34	975 751.63	4 449 761.4
35	975 755.57	4 449 777.06
36	975 888.57	4 449 817.48
37	975 893.55	4 449 815.78
38	975 890.71	4 449 802.29
39	975 889.95	4 449 804.47
40	975 859.84	4 449 810.16
41	975 860.45	4 449 812.29
42	975 880.23	4 449 811.17

Перечень координат поворотных точек земельного участка 86:04:0000001:109671:3У1

Лист 126 из 134

Номер	X	Y	Номер	X	Y	Номер	X	Y
1	954 954 53	4 435 412 89	61	956 056 81	4 436 294 6	121	957 535 87	4 437 508 55
2	954 953 87	4 435 405 95	62	956 056 23	4 436 294 37	122	957 543 43	4 437 508 93
3	954 956 88	4 435 405 67	63	956 058 55	4 436 289 51	123	957 544 01	4 437 509 87
4	954 957 48	4 435 412 56	64	956 061 2	4 436 290 77	124	957 535 22	4 437 511 76
5	954 957 56	4 435 422 73	65	956 058 12	4 436 297 22	125	957 535 64	4 437 513 94
6	954 955 04	4 435 415 67	66	956 059 16	4 436 297 7	126	957 783 57	4 438 148 62
7	954 957 99	4 435 415	67	956 387 78	4 436 317 51	127	957 782 18	4 438 141 31
8	954 960 39	4 435 421 72	68	956 382 37	4 436 313 45	128	957 785 11	4 438 140 77
9	955 158 86	4 436 037 27	69	956 384 16	4 436 311 05	129	957 786 35	4 438 147 49
10	955 161 41	4 436 042 87	70	956 390 28	4 436 315 74	130	957 788 42	4 438 156 92
11	955 159 12	4 436 044 72	71	956 390 29	4 436 325 92	131	957 784 57	4 438 150 98
12	955 158 96	4 436 047 1	72	956 388 97	4 436 319 51	132	957 787 27	4 438 149 56
13	955 156 8	4 436 038 17	73	956 391 62	4 436 317 79	133	957 791 75	4 438 155 02
14	955 159 96	4 436 047 1	74	956 393 24	4 436 325 31	134	957 806 36	4 438 172 81
15	955 161 2	4 436 047 28	75	956 486 35	4 436 688 12	135	957 811 44	4 438 178 99
16	955 163 9	4 436 044 75	76	956 465 9	4 436 685 96	136	957 810 66	4 438 178 06
17	955 169 37	4 436 045 48	77	956 468 18	4 436 685 5	137	957 808 99	4 438 180 64
18	955 168 97	4 436 048 45	78	956 468 51	4 436 687 66	138	957 804 04	4 438 174 7
19	955 948 93	4 436 155 5	79	956 477 8	4 436 741 72	139	957 811 44	4 438 178 99
20	955 957 31	4 436 156 71	80	956 476 29	4 436 737 35	140	957 818 19	4 438 181 02
21	955 955 74	4 436 156 48	81	956 473 7	4 436 725 03	141	957 818 44	4 438 183 93
22	955 955 17	4 436 159 43	82	956 476 64	4 436 724 41	142	957 811 32	4 438 182
23	955 948 41	4 436 158 48	83	956 479 17	4 436 736 47	143	957 812 76	4 438 179 34
24	955 957 31	4 436 156 71	84	956 480 64	4 436 740 76	144	957 819 88	4 438 223 51
25	955 965 64	4 436 159 38	85	956 504 12	4 436 818 63	145	957 977 99	4 438 223
26	955 964 71	4 436 162 23	86	956 501 71	4 436 811 72	146	957 975 63	4 438 225 44
27	955 958 35	4 436 160 17	87	956 504 54	4 436 810 75	147	957 970 13	4 438 223 98
28	955 959 02	4 436 157 26	88	956 506 58	4 436 816 81	148	957 970 9	4 438 221 09
29	956 033 4	4 436 184 47	89	956 513 89	4 436 822 37	149	957 978 86	4 438 223 51
30	956 031 3	4 436 183 79	90	956 505 75	4 436 820 69	150	957 982 09	4 438 232 63
31	956 031 62	4 436 182 81	91	956 508 59	4 436 818 25	151	957 979 18	4 438 233 32
32	956 033 74	4 436 183 4	92	956 514 47	4 436 819 42	152	957 977 71	4 438 227 13
33	956 111 58	4 436 207 72	93	956 913 7	4 436 899 35	153	957 980 34	4 438 225 48
34	956 104 6	4 436 206 25	94	956 907 26	4 436 898 16	154	958 152 41	4 438 963 43
35	956 105 6	4 436 201 43	95	956 907 8	4 436 895 22	155	958 150 8	4 438 956 59
36	956 112 52	4 436 202 76	96	956 915 23	4 436 896 68	156	958 153 73	4 438 955 9
37	956 112 42	4 436 203 28	97	956 922 31	4 436 904	157	958 155 41	4 438 963 15
38	956 110 92	4 436 203 06	98	956 916 5	4 436 900 43	158	958 155 34	4 438 973 04
39	956 110 57	4 436 205 33	99	956 918 08	4 436 897 83	159	958 152 34	4 438 972 9
40	956 111 89	4 436 205 53	100	956 923 92	4 436 901 46	160	958 152 66	4 438 966 02
41	956 182 43	4 436 219 76	101	957 301 66	4 437 135 46	161	958 155 68	4 438 965 71
42	956 176 02	4 436 218 52	102	957 295 24	4 437 131 61	162	957 868 67	4 439 286 85
43	956 176 59	4 436 215 58	103	957 295 23	4 437 128 27	163	957 858 29	4 439 282 55
44	956 183 53	4 436 216 93	104	957 301 77	4 437 132 01	164	957 858 65	4 439 277 74
45	956 192 04	4 436 223 13	105	957 596 31	4 437 334 88	165	957 880 06	4 439 278 43
46	956 185 7	4 436 220 67	106	957 593 54	4 437 327 21	166	957 866 3	4 439 281 77
47	956 186 88	4 436 217 93	107	957 586 87	4 437 322 97	167	957 870 22	4 439 283 6
48	956 193 12	4 436 220 33	108	957 588 49	4 437 320 44	168	957 869 28	4 439 285 58
49	956 059 82	4 436 273 73	109	957 596 2	4 437 325 59	169	957 883 23	4 439 292 48
50	956 067 18	4 436 272 46	110	957 598 24	4 437 334 21	170	957 878 88	4 439 288 61
51	956 070 8	4 436 265 04	111	957 588 48	4 437 502 13	171	957 878 12	4 439 286 88
52	956 071 67	4 436 256 93	112	957 583 16	4 437 501 99	172	957 884 06	4 439 289 59
53	956 074 65	4 436 257 36	113	957 582 74	4 437 498 99	173	957 893 65	4 439 293 78
54	956 073 6	4 436 266 18	114	957 587 54	4 437 498 1	174	957 886 59	4 439 293 41
55	956 073 08	4 436 266 85	115	957 573 87	4 437 503 53	175	957 886 84	4 439 290 42
56	956 070 88	4 436 266 53	116	957 573 12	4 437 500 57	176	957 893 8	4 439 288 78
57	956 071 23	4 436 264 26	117	957 580 49	4 437 498 19	177	958 137 2	4 439 303

Перечень координат поворотных точек
земельного участка
86.04.0000001.109671.3У1

Номер	X	Y
181	958 137.2	4 439 303
182	958 137.2	4 439 305.96
183	958 130.06	4 439 305.66
184	958 130.21	4 439 302.66

Перечень координат поворотных точек
земельного участка 86.04.0000001.15233.3У1

Номер	X	Y
1	956 468.88	4 436 592.79
2	956 464.91	4 436 601.08
3	956 465.81	4 436 605.29
4	956 465.55	4 436 605.2
5	956 464.01	4 436 597.81
6	956 465.36	4 436 591.58

Перечень координат поворотных точек
земельного участка 86.04.0000001.26379.3У1

Номер	X	Y
1	954 852.52	4 434 356.54
2	954 847.36	4 434 355.8
3	954 847	4 434 351.73
4	954 852.16	4 434 352.47
5	954 846.28	4 434 343.5
6	954 851.43	4 434 344.26
7	954 851.79	4 434 348.32
8	954 846.64	4 434 347.57

Перечень координат поворотных точек
земельного участка 86.04.0000001.26343.3У1

Номер	X	Y
1	954 878.73	4 434 655.73
2	954 879.52	4 434 664.7
3	954 874.8	4 434 667.69
4	954 874.01	4 434 658.71

Перечень координат поворотных точек
земельного участка 86.04.0000001.109672.3У1

Номер	X	Y
1	959 236.87	4 448 723.57
2	959 238.88	4 448 722.1
3	959 243.26	4 448 727.63
4	959 240.81	4 448 729.56
5	959 239.68	4 448 727.49
6	959 237.49	4 448 720.34
7	959 229.38	4 448 726.19
8	959 228.52	4 448 724.52
9	959 219.14	4 448 729.88
10	959 220.23	4 448 731.6
11	959 217.54	4 448 732.86
12	959 216.53	4 448 730.99
13	959 331.36	4 448 838.28
14	959 325.34	4 448 838.45
15	959 320.77	4 448 829.92
16	959 323.13	4 448 828.07
17	959 325.41	4 448 835.32
18	959 327.09	4 448 833.98
19	959 328.5	4 448 835.8
20	959 328.84	4 448 837.18

Перечень координат поворотных точек
земельного участка
86.04.0000001.4278.3У1

Номер	X	Y
1	958 133.59	4 439 000.87
2	958 171.27	4 439 009.67
3	958 171.17	4 439 011.7
4	958 133.5	4 439 002.9

Перечень координат поворотных точек земельного
участка 86.04.0000001.4278.3У1

Номер	X	Y
1	958 133.5	4 439 002.9
2	958 171.17	4 439 011.7
3	958 171.08	4 439 013.73
4	958 133.41	4 439 004.93
5	958 171.38	4 439 007.63
6	958 171.27	4 439 009.67
7	958 133.59	4 439 000.87
8	958 133.72	4 438 998.83

Перечень координат поворотных точек
земельного участка 86.04.0000001.8099.3У1

Номер	X	Y
1	957 308.33	4 437 113.05
2	957 308.07	4 437 121.15
3	957 308.07	4 437 121.15
4	957 308.09	4 437 121.16
5	957 307.94	4 437 126.21
6	957 307.66	4 437 135.76
7	957 307.56	4 437 139.27
8	957 307.39	4 437 144.81
9	957 307.08	4 437 153.8
10	957 301.19	4 437 149.95
11	957 301.37	4 437 144.59
12	957 301.66	4 437 135.46
13	957 301.77	4 437 132.01
14	957 301.77	4 437 132
15	957 301.77	4 437 132
16	957 302.08	4 437 122.43
17	957 302.08	4 437 109.99

Перечень координат поворотных точек земельного участка
86.04.0000001.1076.3У1

Номер	X	Y
1	958 141.8	4 438 974.18
2	958 167.56	4 438 980.76
3	958 172.56	4 438 982.04
4	958 172.2	4 438 990.21
5	958 140.2	4 438 982.04

Перечень координат поворотных точек
земельного участка 86.04.0000001.25861.3У1

Номер	X	Y
1	955 980.74	4 436 149
2	958 001.19	4 436 155.44
3	956 001.74	4 436 182.62
4	955 981.34	4 436 176.46
5	955 997.79	4 436 160.86
6	955 997.88	4 436 161.83
7	955 998.88	4 436 161.86
8	955 996.78	4 436 160.83

Перечень координат поворотных точек земельного
участка 86.04.0000001.110006.3У1

Номер	X	Y
1	954 222.98	4 431 161.84
2	954 222.8	4 431 158.89
3	954 224.03	4 431 158.67
4	954 224.02	4 431 161.72
5	954 196.86	4 431 165.23
6	954 184.39	4 431 164.74
7	954 190.99	4 431 164.41
8	954 190.99	4 431 163.9
9	954 188.74	4 431 163.93
10	954 188.74	4 431 164.19
11	954 188.07	4 431 164.13
12	954 189.06	4 431 163.59
13	954 197.5	4 431 162.29
14	954 183.02	4 431 170.33
15	954 181.81	4 431 187.68
16	954 186.5	4 431 184.99
17	954 188.75	4 431 165.21
18	954 188.76	4 431 166.19
19	954 190.99	4 431 166.18
20	954 190.99	4 431 165.41
21	954 194.29	4 431 165.73
22	954 194.43	4 431 165.77
23	954 190.26	4 431 166.37
24	954 165.49	4 431 176.89
25	954 164.23	4 431 174.92
26	954 167.8	4 431 172.73
27	954 166	4 431 174.5
28	954 172.72	4 431 172.49
29	954 174.23	4 431 175.16
30	954 171.31	4 431 176.79
31	954 235.22	4 432 414.54
32	954 235.32	4 432 406.82
33	954 238.33	4 432 406.86
34	954 238.21	4 432 414.27
35	954 237.14	4 432 424
36	954 235.55	4 432 416.91
37	954 238.49	4 432 416.47
38	954 240.06	4 432 423.32
39	954 272.03	4 432 562.59
40	954 273.87	4 432 569.58
41	954 270.82	4 432 570.54
42	954 269.11	4 432 563.26
43	954 274.35	4 432 571.68
44	954 277.24	4 432 578.39
45	954 274.5	4 432 579.58
46	954 271.56	4 432 572.7
47	954 365.33	4 432 786.97
48	954 363.05	4 432 781.77
49	954 365.8	4 432 780.57
50	954 368.08	4 432 785.77
51	954 633.95	4 433 532.58
52	954 635.61	4 433 535.08
53	954 629.44	4 433 539.18
54	954 628.22	4 433 536.4
55	954 627	4 433 540.17

Перечень координат поворотных точек
земельного участка
86-04-0000001:10006-3У1

Номер	X	Y
59	954 592.44	4 433 548.62
60	954 591.74	4 433 544.09
61	954 593.58	4 433 543.72
62	954 599.01	4 433 542.63
63	954 599.61	4 433 545.58
64	954 592.35	4 433 547.13
65	954 592.81	4 433 548.6
66	954 788.2	4 433 806.72
67	954 785.8	4 433 800.39
68	954 788.6	4 433 799.32
69	954 791.32	4 433 806.68
70	954 790.53	4 433 816.32
71	954 787.56	4 433 815.9
72	954 788.61	4 433 809.11
73	954 791.54	4 433 809.04
74	954 780.75	4 433 890.35
75	954 777.84	4 433 889.65
76	954 778.8	4 433 882.77
77	954 781.77	4 433 883.17
78	954 777.31	4 433 899.9
79	954 774.53	4 433 898.78
80	954 777.34	4 433 891.79
81	954 780.22	4 433 892.56
82	954 731.57	4 434 005.89
83	954 734.36	4 434 006.69
84	954 731.71	4 434 013.43
85	954 729.11	4 434 012.17
86	954 731.71	4 434 013.43
87	954 738.02	4 434 016.87
88	954 736.63	4 434 019.37
89	954 730.49	4 434 015.87
90	954 792.27	4 434 049.44
91	954 777.35	4 434 041.3
92	954 778.75	4 434 038.79
93	954 790.46	4 434 044.95
94	954 793.51	4 434 046.99
95	954 837.29	4 434 081.06
96	954 836.83	4 434 076.06
97	954 840	4 434 078.18
98	954 840.27	4 434 080.78
99	954 858.38	4 434 320.33
100	954 858	4 434 315.95
101	954 860.99	4 434 315.7
102	954 861.36	4 434 320.02
103	954 859.45	4 434 332.89
104	954 858.95	4 434 326.99
105	954 861.95	4 434 326.78
106	954 862.45	4 434 332.62
107	954 865.68	4 434 403.59
108	954 865.34	4 434 399.62
109	954 868.33	4 434 399.35
110	954 868.68	4 434 403.38
111	954 866.8	4 434 418.55
112	954 866.27	4 434 410.36
113	954 869.25	4 434 410.09
114	954 869.78	4 434 416.28

Перечень координат поворотных точек земельного участка 86-04-0000001:109670-3У1

Номер	X	Y	Номер	X	Y
1	980 698.29	4 444 899.16	61	980 407.01	4 446 156.02
2	980 696.39	4 444 898.77	62	980 404.85	4 446 154.91
3	980 698.14	4 444 891.38	63	980 407.7	4 446 150.72
4	980 699.95	4 444 891.8	64	980 416.22	4 446 155.74
5	980 697.8	4 444 901.32	65	980 111.98	4 446 368.37
6	980 696.2	4 444 908.44	66	980 117.22	4 446 360.36
7	980 694.2	4 444 908.01	67	980 119.48	4 446 362.33
8	980 695.87	4 444 900.96	68	980 116.06	4 446 366.25
9	980 691.49	4 444 929.7	69	980 112.93	4 446 368.35
10	980 689.17	4 444 929.22	70	980 112.78	4 446 368.35
11	980 690.88	4 444 922.01	71	980 108.18	4 446 375.08
12	980 693.11	4 444 922.53	72	980 105.96	4 446 373.07
13	980 689.37	4 444 939.17	73	980 111.16	4 446 367.3
14	980 686.94	4 444 938.64	74	980 111.21	4 446 369.41
15	980 688.69	4 444 931.35	75	980 112.92	4 446 369.36
16	980 691.01	4 444 931.86	76	980 113.07	4 446 369.36
17	980 568.78	4 445 501.95	77	980 113.33	4 446 369.35
18	980 566.54	4 445 501.63	78	979 660.17	4 446 880.88
19	980 566.57	4 445 501.41	79	979 660.28	4 446 882.55
20	980 567.67	4 445 501.55	80	979 659.42	4 446 881.65
21	980 567.95	4 445 499.61	81	979 134.26	4 447 475.73
22	980 569.14	4 445 499.79	82	979 132.08	4 447 473.65
23	980 559.64	4 445 567.95	83	979 137.43	4 447 467.64
24	980 557.4	4 445 567.63	84	979 139.68	4 447 469.64
25	980 557.72	4 445 565.43	85	979 128.35	4 447 482.35
26	980 560	4 445 565.77	86	979 126.11	4 447 480.36
27	980 549.79	4 445 641.67	87	979 130.46	4 447 475.47
28	980 546.82	4 445 641.25	88	978 131.36	4 447 476.27
29	980 548.36	4 445 630.21	89	979 130.76	4 447 476.29
30	980 549.17	4 445 624.37	90	979 130.83	4 447 479.3
31	980 552.14	4 445 624.78	91	978 926.54	4 447 711.73
32	980 543.51	4 445 688.42	92	978 924.32	4 447 709.71
33	980 540.53	4 445 688	93	978 929.93	4 447 703.42
34	980 542.88	4 445 671.12	94	978 932.18	4 447 705.4
35	980 543.33	4 445 671.18	95	978 920.84	4 447 718.12
36	980 545.86	4 445 671.53	96	978 918.6	4 447 716.13
37	980 528.47	4 445 796.89	97	978 922.78	4 447 711.43
38	980 525.48	4 445 796.49	98	978 924.95	4 447 713.5
39	980 527.77	4 445 779.63	99	978 889.05	4 447 753.37
40	980 530.79	4 445 780.04	100	978 886.87	4 447 751.3
41	980 521.73	4 445 842.06	101	978 891.38	4 447 748.24
42	980 519.65	4 445 841.78	102	978 893.62	4 447 748.23
43	980 519.95	4 445 839.58	103	978 882.29	4 447 760.95
44	980 522.04	4 445 839.89	104	978 880.05	4 447 758.95
45	980 510.54	4 445 901.41	105	978 885.26	4 447 753.1
46	980 507.96	4 445 899.89	106	978 887.46	4 447 755.15
47	980 510.78	4 445 895.1	107	978 219.75	4 448 501.97
48	980 512.91	4 445 895.02	108	978 217.58	4 448 499.92
49	980 512.94	4 445 897.29	109	978 222.77	4 448 494.11
50	980 469.66	4 445 966.66	110	978 225.01	4 448 496.1
51	980 468.67	4 445 965.76	111	978 218	4 448 501.88
52	980 469.53	4 445 964.13	112	978 218.23	4 448 503.67
53	980 469.61	4 445 964.18	113	978 213.68	4 448 508.76
54	980 414.36	4 446 160.57	114	978 211.44	4 448 506.76
55	980 414.35	4 446 160.57	115	977 699.63	4 449 086.18
56	980 410.02	4 446 158.2	116	977 697.76	4 449 084.44
57	980 410.25	4 446 157.67	117	977 697.57	4 449 084.73

Перечень координат поворотных точек земельного участка
86:04:0060001:109670:33/1

Номер	X	Y	Номер	X	Y
121	977 698.16	4 449 087.87	180	975 744.52	4 449 773.62
122	977 693.69	4 449 093.03	181	975 742.29	4 449 773.61
123	977 691.41	4 449 091.09	182	975 742.31	4 449 767.34
124	977 694.21	4 449 087.86	183	975 742.02	4 449 767.34
125	977 697.64	4 449 087.76	184	975 742.21	4 449 765.41
126	977 546.58	4 449 264.2	185	975 746.31	4 449 761.57
127	977 544.36	4 449 262.18	186	975 746.37	4 449 767.36
128	977 549.48	4 449 256.2	187	975 744.59	4 449 767.34
129	977 551.75	4 449 258.17	188	975 764.08	4 449 796.22
130	977 540.7	4 449 271.05	189	975 754.76	4 449 796.22
131	977 538.42	4 449 269.1	190	975 741.81	4 449 785.7
132	977 542.65	4 449 264.16	191	975 741.8	4 449 776.4
133	977 546.05	4 449 265.96	192	975 744.78	4 449 776.5
134	977 212.24	4 449 612.36	193	975 744.66	4 449 784.28
135	977 210.85	4 449 609.69	194	975 756.08	4 449 793.45
136	977 218.43	4 449 605.17	195	975 763.99	4 449 793.21
137	977 224.27	4 449 600.16	196	975 754.64	4 449 796.09
138	977 226.33	4 449 602.34	197	975 754.49	4 449 793.83
139	977 224.44	4 449 605.09	198	975 756.69	4 449 793.68
140	977 218.41	4 449 605.21	199	975 756.84	4 449 795.99
141	977 218.45	4 449 606.15	200	975 743.47	4 449 786.58
142	977 217.78	4 449 606.45	201	975 741.86	4 449 785.07
143	977 218.53	4 449 608.1	202	975 743.39	4 449 783.4
144	977 218.58	4 449 609.3	203	975 745.03	4 449 784.87
145	977 142.96	4 449 646.35			
146	977 142.41	4 449 644.31			
147	977 145.48	4 449 642.59			
148	977 145.57	4 449 642.54			
149	977 150.25	4 449 641.29			
150	977 157.69	4 449 637.4			
151	977 159.68	4 449 641.17			
152	977 158.72	4 449 641.9			
153	977 156.99	4 449 638.32			
154	977 151.49	4 449 640.88			
155	977 153.22	4 449 644.51			
156	977 150.15	4 449 644.11			
157	977 149.43	4 449 641.94			
158	977 151.53	4 449 641.24			
159	977 152.28	4 449 643.44			
160	977 069.71	4 449 666.05			
161	977 069.32	4 449 663.68			
162	977 086.53	4 449 659.56			
163	977 087.03	4 449 661.46			
164	976 528.59	4 449 726.44			
165	976 528.49	4 449 725.59			
166	976 540.81	4 449 724.3			
167	976 540.9	4 449 725.06			
168	976 537.32	4 449 725.46			
169	976 537.32	4 449 725.12			
170	976 531.29	4 449 725.31			
171	976 531.31	4 449 726.13			
172	976 148.26	4 449 759.76			
173	976 153.56	4 449 759.25			
174	976 153.8	4 449 761.88			
175	976 148.52	4 449 762.48			
176	976 142.08	4 449 760.35			

Перечень координат поворотных точек
земельного участка
86:04:0060001:109985:3У1

Лист 129 из 134

Номер	X	Y
1	954 903.2	4 434 826.29
2	954 903.39	4 434 828.35
3	954 905.68	4 434 828.14
4	954 905.52	4 434 826.35
5	954 912.25	4 434 826.54
6	954 913.91	4 434 844.44
7	954 929.6	4 435 015.05
8	954 938.14	4 435 114.85
9	954 923.77	4 435 125.86
10	954 897.43	4 434 826.11
11	954 925.54	4 435 079.96
12	954 925.34	4 435 077.77
13	954 927.64	4 435 077.58
14	954 827.83	4 435 079.77
15	954 910.58	4 434 910.05
16	954 912.88	4 434 909.86
17	954 913.07	4 434 912.05
18	954 910.78	4 434 912.24
19	954 918.16	4 434 996.11
20	954 917.97	4 434 993.91
21	954 920.25	4 434 993.71
22	954 920.45	4 434 995.91
23	955 181.4	4 436 060.54
24	955 171.28	4 436 053.36
25	955 141.74	4 436 048.58
26	955 006.12	4 435 609.68
27	954 938.24	4 435 420.64
28	954 945.54	4 435 412.84
29	954 948.82	4 435 410.97
30	954 925.05	4 435 140.39
31	954 939.43	4 435 129.38
32	954 962.55	4 435 408.19
33	954 963.46	4 435 419.14
34	954 964.34	4 435 425.75
35	955 078.85	4 435 748.07
36	955 174.96	4 436 046.93
37	955 156.8	4 436 038.17
38	955 159.86	4 436 037.27
39	955 161.41	4 436 042.87
40	955 161.92	4 436 044.48
41	955 163.9	4 436 044.75
42	955 169.37	4 436 045.48
43	955 168.97	4 436 046.45
44	955 161.2	4 436 047.29
45	955 159.96	4 436 047.1
46	955 159.12	4 436 044.72
47	954 932.92	4 435 163.82
48	954 932.73	4 435 161.83
49	954 935.01	4 435 161.43
50	954 935.21	4 435 163.83
51	955 135.48	4 435 967.95
52	955 134.83	4 435 965.85
53	955 137.02	4 435 965.17
54	955 137.67	4 435 967.27
55	954 940.3	4 435 247.67
56	954 940.1	4 435 245.47
57	954 942.4	4 435 245.28

Перечень координат поворотных точек земельного участка 66:04:0006001:109983 ЗУ1

Номер	X	Y	Номер	X	Y	Номер	X	Y
60	955 110.32	4 435 886.53	119	955 957.31	4 436 156.71	178	955 921.95	4 436 162.13
61	955 112.52	4 435 885.85	120	955 959.02	4 436 157.26	179	956 125.44	4 436 223.03
62	955 113.17	4 435 887.94	121	955 965.64	4 436 159.38	180	956 046.96	4 436 196.86
63	954 947.68	4 435 331.53	122	956 964.71	4 436 162.23	181	956 001.74	4 436 182.82
64	954 947.49	4 435 329.34	123	956 958.35	4 436 160.17	182	956 001.19	4 436 155.44
65	954 949.77	4 435 329.16	124	956 956.71	4 436 159.64	183	956 079.72	4 436 180.22
66	954 949.98	4 435 331.34	125	956 955.17	4 436 159.43	184	956 088.02	4 436 180.85
67	955 086.46	4 435 809.31	126	955 241.2	4 436 058.38	185	956 134.33	4 436 189.7
68	955 085.81	4 435 807.21	127	955 239.01	4 436 058.07	186	956 133.89	4 436 191.53
69	955 088	4 435 806.52	128	955 239.35	4 436 055.79	187	956 132.58	4 436 196.26
70	955 088.66	4 435 808.63	129	955 241.52	4 436 056.11	188	956 126.93	4 436 216.75
71	954 953.87	4 435 405.95	130	955 878.31	4 436 148.23	189	956 104.6	4 436 206.25
72	954 956.88	4 435 405.67	131	955 876.13	4 436 147.91	190	956 105.6	4 436 201.43
73	954 957.48	4 435 412.56	132	955 876.46	4 436 145.64	191	956 112.52	4 436 202.76
74	954 957.6	4 435 413.89	133	955 878.64	4 436 145.95	192	956 112.42	4 436 203.28
75	954 957.99	4 435 415	134	955 320.92	4 436 069.63	193	956 113.09	4 436 203.38
76	954 960.39	4 435 421.72	135	955 318.75	4 436 069.32	194	956 112.75	4 436 205.65
77	954 957.56	4 435 422.73	136	955 319.06	4 436 067.04	195	956 111.99	4 436 205.53
78	954 955.04	4 435 415.67	137	955 321.25	4 436 067.34	196	956 111.58	4 436 207.72
79	954 954.7	4 435 414.72	138	955 798.68	4 436 137	197	956 032.01	4 436 181.59
80	954 954.53	4 435 412.89	139	955 796.5	4 436 136.69	198	956 032.32	4 436 180.6
81	955 061.97	4 435 729.99	140	955 796.83	4 436 134.41	199	956 034.44	4 436 181.22
82	955 061.32	4 435 727.88	141	955 799.02	4 436 134.73	200	956 034.11	4 436 182.28
83	955 063.51	4 435 727.21	142	955 400.56	4 436 080.85	201	956 033.75	4 436 183.4
84	955 064.16	4 435 729.31	143	955 398.38	4 436 080.54	202	956 033.4	4 436 184.47
85	954 983.45	4 435 483.76	144	955 398.71	4 436 078.26	203	956 031.3	4 436 183.79
86	954 982.72	4 435 481.7	145	955 400.89	4 436 078.58	204	956 031.62	4 436 182.81
87	954 984.88	4 435 480.93	146	955 719.06	4 436 125.77	205	956 094.81	4 436 202.43
88	954 985.62	4 435 482.99	147	955 716.89	4 436 125.47	206	956 092.63	4 436 202.11
89	955 037.45	4 435 650.68	148	955 717.21	4 436 123.19	207	956 092.98	4 436 199.84
90	955 036.8	4 435 648.58	149	955 719.39	4 436 123.5	208	956 095.15	4 436 200.16
91	955 039	4 435 647.89	150	955 480.18	4 436 092.08	209	956 139.22	4 436 221.97
92	955 039.65	4 435 649.89	151	955 478	4 436 091.77	210	956 138	4 436 221.74
93	955 011.51	4 435 571.89	152	955 478.32	4 436 089.49	211	956 138.47	4 436 219.94
94	955 010.76	4 435 569.82	153	955 480.5	4 436 089.8	212	956 145.12	4 436 194.55
95	955 012.93	4 435 569.04	154	955 639.44	4 436 114.55	213	956 438.18	4 436 489.41
96	955 013.66	4 435 571.12	155	956 637.26	4 436 114.23	214	956 412.08	4 436 481.82
97	955 981.34	4 436 176.46	156	956 637.58	4 436 111.96	215	956 394.81	4 436 399.35
98	955 922.82	4 436 158.31	157	956 639.76	4 436 112.27	216	956 387.96	4 436 400.75
99	955 853.4	4 436 122.49	158	956 559.81	4 436 103.31	217	956 372.93	4 436 328.34
100	955 549.2	4 436 110.24	159	956 557.63	4 436 103.01	218	956 353.09	4 436 308.17
101	955 327.47	4 436 087.78	160	956 557.96	4 436 100.73	219	956 335.19	4 436 295.05
102	955 308.47	4 436 086.03	161	956 560.13	4 436 101.05	220	956 326.03	4 436 290.34
103	955 259.32	4 436 079.03	162	956 199.66	4 436 070.58	221	956 282.5	4 436 275.5
104	955 245.94	4 436 073.58	163	956 194.47	4 436 069.81	222	956 180.2	4 436 234.04
105	955 230.26	4 436 064.59	164	956 191.46	4 436 067.68	223	956 156.1	4 436 229.34
106	955 201.19	4 436 050.9	165	956 183.27	4 436 050.31	224	956 162.88	4 436 198.05
107	955 194	4 436 036.56	166	956 185.18	4 436 049.05	225	956 189.12	4 436 203.17
108	955 197.3	4 436 035.33	167	956 190.26	4 436 051.42	226	956 339.16	4 436 261.3
109	955 196.23	4 436 032.53	168	956 240.58	4 436 076.27	227	956 344.52	4 436 260.85
110	955 192.83	4 436 033.82	169	956 211.77	4 436 072.2	228	956 407.15	4 436 306.2
111	955 191.9	4 436 030.98	170	956 204.75	4 436 058.05	229	956 425.17	4 436 393.04
112	955 648.91	4 436 096.07	171	956 227.95	4 436 068.98	230	956 422.18	4 436 393.66
113	955 648.54	4 436 098.62	172	956 940.76	4 436 167.98	231	956 418.31	4 436 394.46
114	955 960.69	4 436 142.67	173	956 644.58	4 436 126.77	232	956 419.77	4 436 465.19
115	955 980.74	4 436 149	174	956 643.64	4 436 133.11	233	956 419.32	4 436 463.04

Номер	X	Y	Номер	X	Y	Номер	X	Y
237	956 176.59	4 436 215.57	296	956 053.49	4 436 284.54	355	956 476.29	4 436 737.35
238	956 183.53	4 436 216.93	297	956 054.58	4 436 280.74	356	956 473.7	4 436 725.03
239	956 185.03	4 436 217.22	298	956 057.57	4 436 289.49	357	956 476.64	4 436 724.41
240	956 186.88	4 436 217.93	299	956 058.39	4 436 270.09	358	956 479.17	4 436 736.47
241	956 193.12	4 436 220.33	300	956 061.73	4 436 262.87	359	956 480.64	4 436 740.76
242	956 192.04	4 436 223.13	301	956 059.53	4 436 262.14	360	956 455.95	4 436 638.32
243	956 185.7	4 436 220.67	302	956 062	4 436 252.81	361	956 455.5	4 436 636.16
244	956 184.23	4 436 220.1	303	956 088.76	4 436 260.52	362	956 457.76	4 436 635.69
245	956 182.43	4 436 219.75	304	956 087.74	4 436 270.81	363	956 458.2	4 436 637.85
246	956 178.02	4 436 218.52	305	956 079.92	4 436 283.8	364	956 466.35	4 436 688.12
247	956 176.58	4 436 215.58	306	956 081.13	4 436 285.74	365	956 465.9	4 436 685.96
248	956 404.01	4 436 389.76	307	956 056.63	4 436 292.87	366	956 468.18	4 436 685.5
249	956 406.25	4 436 389.3	308	956 054.7	4 436 291.81	367	956 468.61	4 436 687.66
250	956 406.26	4 436 389.3	309	956 055.82	4 436 289.8	368	956 465.58	4 436 684.4
251	956 406.71	4 436 391.44	310	956 057.75	4 436 290.86	369	956 465.11	4 436 682.14
252	956 404.46	4 436 391.91	311	956 069.82	4 436 273.73	370	956 467.25	4 436 681.67
253	956 259.64	4 436 248.93	312	956 067.18	4 436 272.46	371	956 467.74	4 436 683.93
254	956 257.58	4 436 248.15	313	956 070.8	4 436 265.04	372	957 281.82	4 437 138.45
255	956 258.41	4 436 246.01	314	956 071.67	4 436 256.93	373	957 239.31	4 437 114.3
256	956 260.46	4 436 246.79	315	956 074.65	4 436 257.36	374	957 238.39	4 437 115.28
257	956 382.37	4 436 313.45	316	956 073.6	4 436 266.18	375	957 190.22	4 437 086.52
258	956 384.16	4 436 311.05	317	956 445.09	4 436 522.41	376	957 190.16	4 437 086.49
259	956 390.28	4 436 315.74	318	956 418.61	4 436 513	377	957 113.74	4 437 040.87
260	956 391.36	4 436 316.58	319	956 413.96	4 436 490.79	378	956 919.66	4 436 917.68
261	956 391.82	4 436 317.79	320	956 440.05	4 436 498.34	379	956 874.07	4 436 905.87
262	956 393.24	4 436 325.31	321	956 442.4	4 436 509.56	380	956 729.94	4 436 874.91
263	956 390.29	4 436 325.92	322	956 430.16	4 436 514.92	381	956 677.03	4 436 866.41
264	956 388.97	4 436 319.51	323	956 429.71	4 436 512.76	382	956 677.56	4 436 863.89
265	956 388.69	4 436 318.19	324	956 431.96	4 436 512.29	383	956 509.63	4 436 832.16
266	956 387.78	4 436 317.51	325	956 432.41	4 436 514.44	384	956 493.28	4 436 820.63
267	956 335.27	4 436 278.97	326	956 451.33	4 436 562.24	385	956 476.78	4 436 769.6
268	956 332.97	4 436 277.29	327	956 449.76	4 436 551.67	386	956 473.45	4 436 756.91
269	956 330	4 436 276.13	328	956 433.41	4 436 546	387	956 499.02	4 436 762.06
270	956 330.81	4 436 274.09	329	956 425.27	4 436 543.05	388	956 515.74	4 436 811.07
271	956 333.97	4 436 275.31	330	956 424.87	4 436 542.91	389	956 688.55	4 436 845.44
272	956 336.52	4 436 277.16	331	956 422.93	4 436 533.64	390	956 899.82	4 436 838.56
273	956 103.25	4 436 227.01	332	956 449.42	4 436 543.05	391	956 851.7	4 436 866.91
274	956 077.36	4 436 216.06	333	956 457.7	4 436 582.61	392	956 851.27	4 436 889.29
275	956 064.83	4 436 211.82	334	956 445.8	4 436 578.52	393	956 921.94	4 436 883.15
276	956 067.9	4 436 207.98	335	956 445.5	4 436 577.1	394	956 993.78	4 436 927.54
277	956 111.06	4 436 222.37	336	956 443.25	4 436 577.56	395	957 241.23	4 437 079.55
278	956 091.12	4 436 242.35	337	956 443.27	4 436 577.66	396	957 238.59	4 437 083.81
279	956 077.74	4 436 238.03	338	956 431.29	4 436 573.54	397	957 281.71	4 437 109.95
280	956 077.74	4 436 238.14	339	956 428.13	4 436 558.46	398	957 281.96	4 437 125.64
281	956 063.08	4 436 233.52	340	956 431.31	4 436 558.59	399	957 281.91	4 437 135.92
282	956 063.64	4 436 232.16	341	956 448.1	4 436 565.84	400	957 226.92	4 437 091.09
283	956 091.6	4 436 241.26	342	956 454.73	4 436 568.43	401	957 225.03	4 437 089.88
284	956 091.74	4 436 241.81	343	956 456.28	4 436 575.81	402	957 226.21	4 437 087.99
285	956 071.72	4 436 304.35	344	956 458.95	4 436 579	403	957 228.1	4 437 089.11
286	956 068.04	4 436 302.58	345	956 496.77	4 436 765.49	404	956 487.42	4 436 768.45
287	956 067.11	4 436 304.08	346	956 471.75	4 436 750.45	405	956 488.79	4 436 766.24
288	956 058.64	4 436 296.83	347	956 454.83	4 436 685.95	406	956 488.89	4 436 765.61
289	956 059.16	4 436 297.7	348	956 432.72	4 436 580.4	407	956 489.54	4 436 767.83
290	956 058.12	4 436 297.22	349	956 459.12	4 436 589.45	408	957 162.58	4 437 052.33
291	956 061.2	4 436 290.77	350	956 473.06	4 436 655.98	409	957 163.77	4 437 050.37
292	956 058.55	4 436 289.51	351	956 473.95	4 436 680.21	410	957 165.64	4 437 051.53
293	956 056.23	4 436 284.37						

Номер	X	Y	Номер	X	Y	Номер	X	Y
414	956 504.54	4 436 810.75	473	957 295.24	4 437 131.61	532	957 794.55	4 438 145.01
415	956 506.58	4 436 816.81	474	957 301.66	4 437 135.46	533	957 816.28	4 438 171.4
416	956 506.96	4 436 817.93	475	957 301.37	4 437 144.59	534	957 997.17	4 438 220.26
417	956 508.59	4 436 818.25	476	957 301.18	4 437 149.94	535	958 021.97	4 438 324.52
418	956 514.47	4 436 819.42	477	957 294.89	4 437 145.88	536	958 015.16	4 438 326.14
419	956 513.89	4 436 822.37	478	957 307.56	4 437 139.27	537	958 068.54	4 438 551.26
420	956 505.75	4 436 820.69	479	957 306.82	4 437 140.1	538	958 062.24	4 438 560.1
421	956 504.77	4 436 820.49	480	957 309.04	4 437 139.77	539	958 048.9	4 438 526.64
422	957 100.46	4 437 013.88	481	957 313.79	4 437 142.89	540	958 048.39	4 438 523.51
423	957 101.67	4 437 011.92	482	957 313.08	4 437 157.7	541	958 050.63	4 438 522.97
424	957 103.55	4 437 013.1	483	957 307.08	4 437 153.8	542	958 051.14	4 438 525.12
425	957 102.34	4 437 015.04	484	957 307.39	4 437 144.81	543	957 418.59	4 437 211.84
426	956 587.51	4 436 836.24	485	957 335.59	4 437 154.51	544	957 416.76	4 437 210.63
427	956 587.95	4 436 833.99	486	957 327.91	4 437 149.45	545	957 418.03	4 437 208.7
428	956 590.12	4 436 834.39	487	957 328.43	4 437 139.42	546	957 419.86	4 437 209.93
429	956 589.68	4 436 836.66	488	957 345.21	4 437 150.24	547	958 030.47	4 438 447.98
430	957 038.41	4 436 975.48	489	957 327.77	4 437 152.1	548	958 029.96	4 438 445.84
431	957 039.63	4 436 973.53	490	957 333.1	4 437 155.61	549	958 032.19	4 438 445.3
432	957 041.5	4 436 974.7	491	957 327.46	4 437 158.11	550	958 032.69	4 438 447.45
433	957 040.29	4 436 978.64	492	958 050.26	4 438 578.15	551	957 471.28	4 437 246.46
434	956 671.77	4 436 852.45	493	957 991.82	4 438 331.69	552	957 472.55	4 437 244.54
435	956 689.61	4 436 852.05	494	957 985	4 438 333.31	553	957 474.38	4 437 245.75
436	956 670.04	4 436 849.79	495	957 960.47	4 438 230.19	554	957 473.11	4 437 247.68
437	956 672.2	4 436 850.21	496	957 804.94	4 438 189.09	555	958 012.92	4 438 374
438	956 978.25	4 436 938.24	497	957 782.17	4 438 161.46	556	958 012.41	4 438 371.86
439	956 976.37	4 436 937.08	498	957 745.39	4 438 011.81	557	958 014.65	4 438 371.33
440	956 977.58	4 436 935.13	499	957 730.3	4 437 931.64	558	958 015.15	4 438 373.47
441	956 979.46	4 436 936.29	500	957 735.21	4 437 930.69	559	957 532.23	4 437 286.51
442	956 753.2	4 436 868.13	501	957 693.37	4 437 707.61	560	957 533.5	4 437 284.6
443	956 751.04	4 436 867.72	502	957 635.7	4 437 524.54	561	957 535.34	4 437 285.82
444	956 751.48	4 436 865.46	503	957 631.36	4 437 510.76	562	957 534.07	4 437 287.73
445	956 753.63	4 436 865.87	504	957 611.92	4 437 510.25	563	957 534.06	4 437 287.72
446	956 907.26	4 436 896.16	505	957 606.81	4 437 492.09	564	957 534.06	4 437 287.73
447	956 907.6	4 436 895.22	506	957 623.31	4 437 492.56	565	957 995.36	4 438 300.03
448	956 915.23	4 436 896.68	507	957 588.54	4 437 350.82	566	957 994.85	4 438 297.88
449	956 916.67	4 436 896.96	508	957 584.34	4 437 333.72	567	957 997.08	4 438 297.38
450	956 918.08	4 436 897.83	509	957 371.6	4 437 195.89	568	957 997.61	4 438 299.5
451	956 923.92	4 436 901.46	510	957 368.04	4 437 193.58	569	957 595.31	4 437 334.88
452	956 922.32	4 436 904.01	511	957 360.43	4 437 188.64	570	957 593.54	4 437 327.21
453	956 922.31	4 436 904	512	957 359.17	4 437 190.22	571	957 586.87	4 437 322.97
454	956 922.31	4 436 904.01	513	957 357.15	4 437 188.84	572	957 588.49	4 437 320.44
455	956 916.5	4 436 900.43	514	957 358.52	4 437 187.34	573	957 596.2	4 437 325.59
456	956 915.18	4 436 899.62	515	957 326.88	4 437 166.71	574	957 598.24	4 437 334.21
457	956 913.7	4 436 899.35	516	957 327.02	4 437 166.53	575	957 970.13	4 438 223.98
458	956 835.08	4 436 883.9	517	957 340.54	4 437 160.5	576	957 970.9	4 438 221.09
459	956 832.92	4 436 883.48	518	957 359.01	4 437 172.66	577	957 977.99	4 438 223
460	956 833.36	4 436 881.22	519	957 359	4 437 172.67	578	957 979.86	4 438 223.51
461	956 835.52	4 436 881.64	520	957 360.84	4 437 173.87	579	957 980.34	4 438 225.46
462	957 301.77	4 437 132	521	957 362.09	4 437 171.95	580	957 982.09	4 438 232.63
463	957 295.23	4 437 128.27	522	957 343.02	4 437 159.4	581	957 979.18	4 438 233.32
464	957 295.2	4 437 118.14	523	957 352.71	4 437 155.09	582	957 977.71	4 438 227.13
465	957 302.06	4 437 122.43	524	957 385.47	4 437 176.28	583	957 977.42	4 438 225.92
466	957 313.92	4 437 140.24	525	957 605.37	4 437 318.76	584	957 975.63	4 438 225.44
467	957 310.28	4 437 137.83	526	957 648.81	4 437 499.92	585	957 596.35	4 437 338.6
468	957 310.45	4 437 137.57	527	957 711.98	4 437 706.66	586	957 595.82	4 437 336.46
469	957 307.66	4 437 135.76	528	957 752.89	4 437 927.39	587	957 598.05	4 437 335.81
470	957 307.95	4 437 126.21						

Номер	X	Y	Номер	X	Y	Номер	X	Y
591	957 893.85	4 438 201.12	650	957 720.55	4 437 795.67	709	958 100.69	4 438 743.9
592	957 895.99	4 438 201.69	651	957 720.96	4 437 797.84	710	958 100.19	4 438 741.77
593	957 815.57	4 437 415.58	652	957 718.71	4 437 798.27	711	958 102.43	4 438 741.22
594	957 815.04	4 437 413.44	653	957 587.54	4 437 499.1	712	958 102.93	4 438 743.37
595	957 817.27	4 437 412.89	654	957 582.74	4 437 498.99	713	958 187.56	4 438 980.76
596	957 817.8	4 437 415.03	655	957 581.75	4 437 498.96	714	958 141.8	4 438 974.18
597	957 804.04	4 438 174.7	656	957 580.49	4 437 499.19	715	958 138.36	4 438 949.73
598	957 806.36	4 438 172.8	657	957 573.11	4 437 500.57	716	958 167.94	4 438 957.87
599	957 810.66	4 438 178.06	658	957 573.67	4 437 503.53	717	958 150.8	4 438 956.59
600	957 811.44	4 438 178.99	659	957 580.8	4 437 502.18	718	958 153.73	4 438 965.9
601	957 812.76	4 438 179.34	660	957 581.83	4 437 501.97	719	958 155.41	4 438 963.15
602	957 819.19	4 438 181.02	661	957 583.16	4 437 502	720	958 155.73	4 438 964.54
603	957 818.44	4 438 183.93	662	957 588.48	4 437 502.13	721	958 155.68	4 438 965.71
604	957 811.32	4 438 182	663	957 590.83	4 437 509.7	722	958 155.34	4 438 973.04
605	957 809.77	4 438 181.58	664	957 582.63	4 437 509.48	723	958 152.34	4 438 972.9
606	957 808.99	4 438 180.64	665	957 534.4	4 437 519.66	724	958 152.66	4 438 966.02
607	957 835.41	4 437 506.1	666	957 533.6	4 437 514.32	725	958 152.72	4 438 964.76
608	957 833.81	4 437 499.9	667	957 535.65	4 437 513.94	726	958 152.41	4 438 963.43
609	957 836.11	4 437 499.26	668	957 535.22	4 437 511.76	727	958 171.36	4 439 007.62
610	957 838.24	4 437 498.71	669	957 544.01	4 437 509.87	728	958 133.72	4 438 996.83
611	957 839.94	4 437 504.74	670	957 543.43	4 437 506.93	729	958 140.2	4 438 982.04
612	957 837.84	4 437 505.39	671	957 535.87	4 437 508.55	730	958 172.2	4 438 990.21
613	957 782.16	4 438 141.31	672	957 536.11	4 437 508.42	731	958 156.73	4 439 324.53
614	957 785.11	4 438 140.77	673	957 533.87	4 437 504.37	732	958 098.53	4 439 321.54
615	957 786.35	4 438 147.49	674	957 541.87	4 437 501.38	733	958 109.98	4 439 310.3
616	957 786.69	4 438 148.76	675	957 541.33	4 437 499.76	734	958 112.39	4 439 306.29
617	957 787.27	4 438 149.58	676	957 541.33	4 437 499.76	735	958 116.98	4 439 298.42
618	957 791.75	4 438 155.02	677	957 560.93	4 437 495.65	736	958 120.22	4 439 291.01
619	957 789.42	4 438 156.93	678	957 561.99	4 437 495.43	737	958 123.54	4 439 273.01
620	957 784.57	4 438 150.98	679	957 581	4 437 491.44	738	958 124.2	4 439 254.37
621	957 783.86	4 438 150.11	680	957 585.18	4 437 491.55	739	958 123.64	4 439 217.24
622	957 783.57	4 438 148.62	681	957 539.17	4 437 507.24	740	958 133.44	4 439 004.94
623	957 658.96	4 437 572.46	682	957 536.9	4 437 505.06	741	958 171.08	4 439 013.73
624	957 658.31	4 437 570.36	683	957 541.17	4 437 504.76	742	958 157.77	4 439 301.9
625	957 660.49	4 437 569.67	684	957 541.45	4 437 506.95	743	958 137.2	4 439 303
626	957 661.15	4 437 571.77	685	957 593.82	4 437 491.78	744	958 137.52	4 439 296
627	957 767.87	4 438 062.6	686	957 595.01	4 437 491.81	745	958 140.52	4 439 296.14
628	957 767.45	4 438 060.43	687	957 598.25	4 437 504.16	746	958 140.21	4 439 303.15
629	957 769.73	4 438 060.02	688	958 162.66	4 438 948.17	747	958 140.07	4 439 306.08
630	957 770.13	4 438 062.18	689	958 136.27	4 438 940.9	748	958 137.2	4 439 305.96
631	957 680.06	4 437 638.27	690	958 053.81	4 438 593.11	749	958 130.06	4 439 305.66
632	957 682.26	4 437 638.56	691	958 071.43	4 438 586.49	750	958 130.21	4 439 302.66
633	957 682.91	4 437 640.68	692	958 071.97	4 438 565.73	751	958 151.43	4 439 050.54
634	957 680.72	4 437 641.36	693	958 135.8	4 438 891.86	752	958 149.13	4 439 050.43
635	957 751.48	4 437 974.49	694	958 135.29	4 438 889.73	753	958 149.23	4 439 048.24
636	957 751.08	4 437 972.32	695	958 137.52	4 438 889.19	754	958 151.53	4 439 048.34
637	957 753.33	4 437 971.91	696	958 138.04	4 438 891.34	755	958 143.63	4 439 220.75
638	957 753.74	4 437 974.06	697	958 066.44	4 438 599.53	756	958 141.32	4 439 220.64
639	957 701.26	4 437 706.34	698	958 065.93	4 438 597.39	757	958 141.43	4 439 218.44
640	957 703.36	4 437 705.66	699	958 068.16	4 438 596.86	758	958 143.73	4 439 218.55
641	957 704.3	4 437 708.67	700	958 068.67	4 438 599	759	958 147.52	4 439 135.72
642	957 704.84	4 437 711.72	701	958 118.25	4 438 817.88	760	958 145.23	4 439 135.61
643	957 702.67	4 437 712.11	702	958 117.73	4 438 815.75	761	958 145.33	4 439 133.41
644	957 702.18	4 437 709.25	703	958 119.97	4 438 815.21	762	958 147.62	4 439 133.52
645	957 735.08	4 437 886.37	704	958 120.48	4 438 817.36	763	957 858.29	4 439 282.55
646	957 734.68	4 437 884.21	705	958 083.14	4 438 689.92	764	957 868.67	4 439 286.85
647	957 736.95	4 437 883.8						

Номер	X	Y	Номер	X	Y
768	957 866.33	4 439 281.77	827	958 079.89	4 439 320.58
769	957 867.69	4 439 277.8	828	958 031.78	4 439 318.1
770	957 878.93	4 439 278.54	829	958 018.35	4 439 303.91
771	957 894.94	4 439 279.9	830	958 006.47	4 439 294.57
772	957 938.45	4 439 303.14	831	958 004.51	4 439 291.99
773	957 938.41	4 439 305.52	832	958 004.07	4 439 289.13
774	957 937.74	4 439 305.51	833	958 034.39	4 439 291.76
775	957 937.71	4 439 308.4	834	958 077.69	4 439 295.16
776	957 919.13	4 439 305.47	835	958 099.53	4 439 293.96
777	957 919.04	4 439 307.47	836	958 096.42	4 439 307.58
778	957 902.85	4 439 306.9	837	958 096.27	4 439 307.69
779	957 902.92	4 439 304.66	838	958 055.2	4 439 301.56
780	957 882.3	4 439 303.64	839	958 053	4 439 301.45
781	957 855.46	4 439 290.92	840	958 053.13	4 439 289.15
782	957 854	4 439 274.87	841	958 055.32	4 439 299.28
783	957 856.22	4 439 275.29	842	958 107.51	4 439 304.75
784	957 856.19	4 439 277.01	843	958 106.96	4 439 304.36
785	957 857.64	4 439 277.04	844	958 109.18	4 439 298.28
786	957 857.63	4 439 277.63	845	958 110.46	4 439 293.35
787	957 859.65	4 439 277.72	846	958 113.82	4 439 293.16
788	957 876.88	4 439 289.61	847	958 112.56	4 439 296.13
789	957 878.12	4 439 286.88	848	958 101.9	4 439 300.87
790	957 884.06	4 439 289.59	849	958 103.58	4 439 293.75
791	957 885.75	4 439 290.36	850	958 104.24	4 439 293.71
792	957 886.84	4 439 290.42	851	958 103.41	4 439 296.78
793	957 893.8	4 439 290.78	852	958 023.42	4 439 310.67
794	957 893.65	4 439 293.78	853	958 013.09	4 439 310.16
795	957 886.59	4 439 293.41	854	958 006.34	4 439 295.71
796	957 885.14	4 439 293.34	855	958 008.65	4 439 297.58
797	957 883.23	4 439 292.48	856	958 017.78	4 439 304.66
798	957 869.41	4 439 282.94			
799	957 867.55	4 439 281.77			
800	957 868.78	4 439 279.82			
801	957 870.83	4 439 281.01			
802	958 010.07	4 439 310.01			
803	957 962.43	4 439 307.63			
804	957 962.29	4 439 309.73			
805	957 946.53	4 439 308.65			
806	957 946.62	4 439 308.84			
807	957 940.06	4 439 306.52			
808	957 940.07	4 439 305.98			
809	957 939.4	4 439 305.8			
810	957 939.46	4 439 302.56			
811	957 898.01	4 439 280.13			
812	957 924.78	4 439 282.36			
813	957 977.75	4 439 286.89			
814	957 997.08	4 439 288.52			
815	958 004.58	4 439 294.32			
816	958 010.82	4 439 307.78			
817	958 010.03	4 439 308.42			
818	958 006.1	4 439 303.38			
819	958 005.31	4 439 303.96			
820	957 970.73	4 439 297.3			
821	957 968.53	4 439 297.19			
822	957 968.65	4 439 294.89			
823	957 970.85	4 439 295.01			

2. В Приложении 18:

2.1. Подраздел «Перечень и сведения о площади образуемых земельных участков, которые будут отнесены к территориям общего пользования или имуществу общего пользования, в том числе в отношении которых предполагаются резервирование и (или) изъятие для государственных или муниципальных нужд» изложить в следующей редакции:

«

Перечень и сведения о площади образуемых земельных участков, которые будут отнесены к территориям общего пользования или имуществу общего пользования, в том числе в отношении которых предполагаются резервирование и (или) изъятие для государственных или муниципальных нужд

В проекте межевания территории отсутствуют образуемые земельные участки, которые после образования будут относиться к территориям общего пользования или имуществу общего пользования.

Изъятие земельных участков для государственных и муниципальных нужд для размещения проектируемого объекта не требуется.

Таблица 1

Площади испрашиваемых земельных участков
под проектируемый объект

Наименование объекта	Номер земельного участка	Способ образования	Площадь земельного участка, га	Категория земель
Одноцепная ВЛ-10кВ. БГПК-554км. L=15.4км. КТПН-3шт	86:04:0000001:36247:3У1	Образование земельного участка путем раздела с сохранением земельного участка в измененных границах с кадастровым номером 86:04:0000001:36247	1,2682	Земли лесного фонда
	86:04:0000001:36247:3У11		0,2285	
Одноцепная ВЛ-10кВ. БГПК-554км. L=15.4км. КТПН-3шт	86:04:0000001:109986:3У1	Образование земельного участка путем раздела с сохранением земельного участка в измененных границах с кадастровым номером 86:04:0000001:109986	3,4749	
	86:04:0000001:109986:3У2		0,0097	
Одноцепная ВЛ-10кВ. БГПК-554км. L=15.4км. КТПН-3шт	86:04:0000001:103576:3У1	Образование земельного участка путем раздела с сохранением земельного участка в измененных границах с кадастровым номером 86:04:0000001:103576	0,0251	
Одноцепная ВЛ-10кВ. БГПК-554км. L=15.4км. КТПН-3шт	86:04:0000001:32261:3У1	Образование земельного участка путем раздела с сохранением земельного участка в измененных границах с кадастровым номером 86:04:0000001:32261	12,9164	
	86:04:0000001:32261:3У2		0,0914	
Одноцепная ВЛ-10кВ. БГПК-554км. L=15.4км. КТПН-3шт	86:04:0000001:32259:3У1	Образование земельного участка путем раздела с сохранением земельного участка в измененных границах с кадастровым номером 86:04:0000001:32259	0,1503	
	86:04:0000001:32259:3У2		0,0033	

Одноцепная ВЛ-10кВ. БГПК-554км. L=15.4км. КТПН-3шт	86:04:0000001:22138:3У1	Образование земельного участка путем раздела с сохранением земельного участка в измененных границах с кадастровым номером 86:04:0000001:22138	0,0039	Земли лесного фонда
	86:04:0000001:22138:3У2		0,001	
Одноцепная ВЛ-10кВ. БГПК-554км. L=15.4км. КТПН-3шт	86:04:0000001:109991:3У1	Образование земельного участка путем раздела с сохранением земельного участка в измененных границах с кадастровым номером 86:04:0000001:109991	1,0152	
Одноцепная ВЛ-10кВ. БГПК-554км. L=15.4км. КТПН-3шт	86:04:0000001:24347:3У1	Образование земельного участка путем раздела с сохранением земельного участка в измененных границах с кадастровым номером 86:04:0000001:24347	0,0062	
Одноцепная ВЛ-10кВ. БГПК-554км. L=15.4км. КТПН-3шт	86:04:0000001:119410:3У1	Образование земельного участка путем раздела с сохранением земельного участка в измененных границах с кадастровым номером 86:04:0000001:119410	0,0192	
Одноцепная ВЛ-6кВ. 583-619. L=35,5км. КТПН-15шт.	86:04:0000001:36247:3У2	Образование земельного участка путем раздела с сохранением земельного участка в измененных границах с кадастровым номером 86:04:0000001:36247	6,1058	
	86:04:0000001:36247:3У7		0,0026	
	86:04:0000001:36247:3У13		0,0062	
Одноцепная ВЛ-6кВ. 583-619. L=35,5км. КТПН-15шт.	86:04:0000001:109999:3У1	Образование земельного участка путем раздела с сохранением земельного участка в измененных границах с кадастровым номером 86:04:0000001:109999	27,2107	
	86:04:0000001:109999:3У2		0,0850	
	86:04:0000001:109999:3У3		0,0012	
Одноцепная ВЛ-6кВ. 583-619. L=35,5км. КТПН-15шт.	86:04:0000001:110005:3У1	Образование земельного участка путем раздела с сохранением земельного участка в измененных границах с кадастровым номером 86:04:0000001:110005	0,1506	
	86:04:0000001:110005:3У2		0,102	
Одноцепная ВЛ-6кВ. 583-619. L=35,5км. КТПН-15шт	86:04:0000001:24392:3У1	Образование земельного участка путем раздела с сохранением земельного участка в измененных границах с кадастровым номером 86:04:0000001:110005	0,1119	
Одноцепная ВЛ-6кВ. 583-619. L=35,5км. КТПН-15шт	86:04:0000001:117039:3У1	Образование земельного участка путем раздела с сохранением земельного участка в измененных границах с кадастровым номером 86:04:0000001:117039	0,0282	
Одноцепная ВЛ-6кВ. 583-619. L=35,5км. КТПН-15шт	86:04:0000001:109990:3У1	Образование земельного участка путем раздела с сохранением земельного участка в измененных границах с кадастровым номером 86:04:0000001:109990	0,9061	
Одноцепная ВЛ-6кВ. 583-619.	86:04:0000001:109989:3У1	Образование земельного участка путем раздела с сохранением земельного	0,2282	

L=35,5км. КТПН-15шт		участка в измененных границах с кадастровым номером 86:04:0000001:109989		
Одноцепная ВЛ-6кВ. 583-619. L=35,5км. КТПН-15шт	86:04:0000001:109667:3У1	Образование земельного участка путем раздела с сохранением земельного участка в измененных границах с кадастровым номером 86:04:0000001:109667	0,0128	Земли лесного фонда
	86:04:0000001:109667:3У2		0,0054	
Одноцепная ВЛ-10кВ. БГПК-554км. L=15.4км. КТПН-3шт	86:04:0000001:36247:3У3	Образование земельного участка путем раздела с сохранением земельного участка в измененных границах с кадастровым номером 86:04:0000001:36247	0,2257	
	86:04:0000001:36247:3У12		1,1566	
Одноцепная ВЛ-10кВ. БГПК-554км. L=15.4км. КТПН-3шт	86:04:0000001:109984:3У1	Образование земельного участка путем раздела с сохранением земельного участка в измененных границах с кадастровым номером 86:04:0000001:109984	2,7250	
	86:04:0000001:109984:3У2		0,005	
	86:04:0000001:109984:3У3		18,1927	
	86:04:0000001:109984:3У4		0,0051	
Одноцепная ВЛ-10кВ. БГПК-554км. L=15.4км. КТПН-3шт	86:04:0000001:32239:3У1	Образование земельного участка путем раздела с сохранением земельного участка в измененных границах с кадастровым номером 86:04:0000001:32239	0,0273	
	86:04:0000001:32239:3У2		0,0009	
	86:04:0000001:32239:3У3		0,1714	
	86:04:0000001:32239:3У4		0,0057	
Одноцепная ВЛ-10кВ. БГПК-554км. L=15.4км. КТПН-3шт	86:04:0000001:109983:3У1	Образование земельного участка путем раздела с сохранением земельного участка в измененных границах с кадастровым номером 86:04:0000001:109983	0,0965	
	86:04:0000001:109983:3У2		0,0493	
Одноцепная ВЛ-10кВ. БГПК-554км. L=15.4км. КТПН-3шт	86:04:0000001:109670:3У1	Образование земельного участка путем раздела с сохранением земельного участка в измененных границах с кадастровым номером 86:04:0000001:109670	0,0231	
	86:04:0000001:109670:3У2		0,0097	
	86:04:0000001:109670:3У3		0,0634	
	86:04:0000001:109670:3У4		0,0458	
Одноцепная ВЛ-6кВ. 564-672км. L=8км. КТПН- 2шт	86:04:0000001:36247:3У4	Образование земельного участка путем раздела с сохранением земельного участка в измененных границах с кадастровым номером 86:04:0000001:36247	0,7506	
Одноцепная ВЛ-6кВ. 564-672км. L=8км. КТПН- 2шт	86:04:0000001:109988:3У1	Образование земельного участка путем раздела с сохранением земельного участка в измененных границах с кадастровым номером 86:04:0000001:109988	4,5167	
Одноцепная ВЛ-6кВ. 564-672км. L=8км. КТПН- 2шт	86:04:0000001:109672:3У1	Образование земельного участка путем раздела с сохранением земельного участка в измененных границах с кадастровым номером 86:04:0000001:109672	0,0076	
	86:04:0000001:109672:3У2		0,0071	
Одноцепная ВЛ-6кВ. 583-619. L=35,5км. КТПН-15шт.	86:04:0000001:36247:3У5	Образование земельного участка путем раздела с сохранением земельного участка в измененных границах с кадастровым номером 86:04:0000001:36247	2,8246	
	86:04:0000001:36247:3У8		1,0008	
	86:04:0000001:36247:3У9		0,0020	

Одноцепная ВЛ-6кВ. 583-619. L=35,5км. КТПН-15шт.	86:04:0000001:109985:3У1	Образование земельного участка путем раздела с сохранением земельного участка в измененных границах с кадастровым номером 86:04:0000001:109985	16,7413	Земли лесного фонда
	86:04:0000001:109985:3У2		0,0358	
	86:04:0000001:109985:3У3		0,0140	
Одноцепная ВЛ-6кВ. 583-619. L=35,5км. КТПН-15шт.	86:04:0000001:109671:3У1	Образование земельного участка путем раздела с сохранением земельного участка в измененных границах с кадастровым номером 86:04:0000001:109671	0,0887	
	86:04:0000001:109671:3У2		0,0516	
Одноцепная ВЛ-6кВ. 583-619. L=35,5км. КТПН-15шт.	86:04:0000001:3976:3У1	Образование земельного участка путем раздела с сохранением земельного участка в измененных границах с кадастровым номером 86:04:0000001:3976	0,0260	
Одноцепная ВЛ-6кВ. 583-619. L=35,5км. КТПН-15шт.	86:04:0000001:4279:3У1	Образование земельного участка путем раздела с сохранением земельного участка в измененных границах с кадастровым номером 86:04:0000001:4279	0,0155	
Одноцепная ВЛ-6кВ. 583-619. L=35,5км. КТПН-15шт.	86:04:0000001:4278:3У1	Образование земельного участка путем раздела с сохранением земельного участка в измененных границах с кадастровым номером 86:04:0000001:4278	0,0077	
Одноцепная ВЛ-6кВ. 583-619. L=35,5км. КТПН-15шт.	86:04:0000001:109992:3У1	Образование земельного участка путем раздела с сохранением земельного участка в измененных границах с кадастровым номером 86:04:0000001:109992	1,5113	
Одноцепная ВЛ-6кВ. 583-619. L=35,5км. КТПН-15шт.	86:04:0000001:8099:3У1	Образование земельного участка путем раздела с сохранением земельного участка в измененных границах с кадастровым номером 86:04:0000001:8099	0,0242	
Одноцепная ВЛ-6кВ. 583-619. L=35,5км. КТПН-15шт.	86:04:0000001:25859:3У1	Образование земельного участка путем раздела с сохранением земельного участка в измененных границах с кадастровым номером 86:04:0000001:25859	0,0331	
Одноцепная ВЛ-6кВ. 583-619. L=35,5км. КТПН-15шт.	86:04:0000001:15232:3У1	Образование земельного участка путем раздела с сохранением земельного участка в измененных границах с кадастровым номером 86:04:0000001:15232	0,0023	
Одноцепная ВЛ-6кВ. 583-619. L=35,5км. КТПН-15шт.	86:04:0000001:110002:3У1	Образование земельного участка путем раздела с сохранением земельного участка в измененных границах с кадастровым номером 86:04:0000001:110002	9,4319	
	86:04:0000001:110002:3У2		0,0252	
Одноцепная ВЛ-6кВ. 583-619. L=35,5км.	86:04:0000001:110003:3У1	Образование земельного участка путем раздела с сохранением земельного участка в измененных границах	1,1584	
	86:04:0000001:110003:3У2		0,0001	

КТПН-15шт.		с кадастровым номером 86:04:0000001:110003		
Одноцепная ВЛ-6кВ. 583-619. L=35,5км. КТПН-15шт.	86:04:0000001:110006:3У1	Образование земельного участка путем раздела с сохранением земельного участка в измененных границах с кадастровым номером 86:04:0000001:110006	0,0490	Земли лесного фонда
	86:04:0000001:110006:3У2		0,0445	
Одноцепная ВЛ-6кВ. 583-619. L=35,5км. КТПН-15шт.	86:04:0000001:26579:3У1	Образование земельного участка путем раздела с сохранением земельного участка в измененных границах с кадастровым номером 86:04:0000001:26579	0,0041	
Одноцепная ВЛ-6кВ. 583-619. L=35,5км. КТПН-15шт.	86:04:0000001:26545:3У1	Образование земельного участка путем раздела с сохранением земельного участка в измененных границах с кадастровым номером 86:04:0000001:26545	0,0045	
Одноцепная ВЛ-6кВ. 583-619. L=35,5км. КТПН-15шт.	86:04:0000001:113595:3У1	Образование земельного участка путем раздела с сохранением земельного участка в измененных границах с кадастровым номером 86:04:0000001:113595	0,0012	
	86:04:0000001:113595:3У2		0,8952	
Одноцепная ВЛ-6кВ. 583-619. L=35,5км. КТПН-15шт.	86:04:0000001:113568:3У1	Образование земельного участка путем раздела с сохранением земельного участка в измененных границах с кадастровым номером 86:04:0000001:113568	0,0046	
Одноцепная ВЛ-6кВ. 583-619. L=35,5км. КТПН-15шт.	86:04:0000001:114646:3У1	Образование земельного участка путем раздела с сохранением земельного участка в измененных границах с кадастровым номером 86:04:0000001:114646	0,0022	
	86:04:0000001:114646:3У2		0,0715	
Одноцепная ВЛ-6кВ. 583-619. L=35,5км. КТПН-15шт.	86:04:0000001:114512:3У1	Образование земельного участка путем раздела с сохранением земельного участка в измененных границах с кадастровым номером 86:04:0000001:114512	0,0023	
	86:04:0000001:114512:3У2		0,0534	
Одноцепная ВЛ-6кВ. 583-619. L=35,5км. КТПН-15шт.	86:04:0000001:113593:3У1	Образование земельного участка путем раздела с сохранением земельного участка в измененных границах с кадастровым номером 86:04:0000001:113593	0,0062	
Одноцепная ВЛ-6кВ. 564-672км. L=8км. КТПН- 2шт	86:04:0000001:36247:3У6	Образование земельного участка путем раздела с сохранением земельного участка в измененных границах с кадастровым номером 86:04:0000001:36247	0,3745	
	86:04:0000001:36247:3У10		0,0005	
	86:04:0000001:36247:3У14		0,3165	
Одноцепная ВЛ-6кВ. 564-672км. L=8км. КТПН- 2шт	86:04:0000001:109982:3У1	Образование земельного участка путем раздела с сохранением земельного участка в измененных границах с кадастровым номером 86:04:0000001:109982	2,6906	
	86:04:0000001:109982:3У2		0,0016	
Одноцепная	86:04:0000001:109669:3У1	Образование земельного	0,0032	

ВЛ-6кВ. 564-672км. L=8км. КТПН- 2шт	86:04:0000001:109669:3У2	участка путем раздела с сохранением земельного участка в измененных границах с кадастровым номером 86:04:0000001:109669	0,0081	
Одноцепная ВЛ-6кВ. 564-672км. L=8км. КТПН- 2шт	86:04:0000001:109668:3У1	Образование земельного участка путем раздела с сохранением земельного участка в измененных границах с кадастровым номером 86:04:0000001:109668	0,0065	
	86:04:0000001:109668:3У2		0,0152	
Одноцепная ВЛ-6кВ. 564-672км. L=8км. КТПН- 2шт	86:04:0000001:109987:3У1	Образование земельного участка путем раздела с сохранением земельного участка в измененных границах с кадастровым номером 86:04:0000001:109987	3,3143	Земли лесного фонда
	86:04:0000001:109987:3У2		0,0015	
Одноцепная ВЛ-6кВ. 564-672км. L=8км. КТПН- 2шт	86:04:0000001:109981:3У1	Образование земельного участка путем раздела с сохранением земельного участка в измененных границах с кадастровым номером 86:04:0000001:109981	0,0450	Земли запаса
Одноцепная ВЛ-10кВ. БГПК-554км. L=15.4км. КТПН-3шт	86:04:0000001:3У9	Образование земельного участка путем раздела с сохранением земельного участка в измененных границах с кадастровым номером 86:04:0000001	0,4064	
	86:04:0000001:3У12		0,0102	
Одноцепная ВЛ-6кВ. 564-672км. L=8км. КТПН-2шт	86:04:0000001:3У10		1,7684	
Одноцепная ВЛ-6кВ. 583-619. L=35,5км. КТПН-15шт.	86:04:0000001:3У11		0,2999	
	86:04:0000001:3У13		0,0038	
Одноцепная ВЛ-10кВ. БГПК-554км. L=15.4км. КТПН-3шт	86:04:0000001:98340:3У1	Образование земельного участка путем раздела с сохранением земельного участка в измененных границах с кадастровым номером 86:04:0000001:98340	0,0053	Земли промышле н-ности
	86:04:0000001:98340:3У2		0,0004	
Одноцепная ВЛ-10кВ. БГПК-554км. L=15.4км. КТПН-3шт	86:04:0000001:6261:3У1	Образование земельного участка путем раздела с сохранением земельного участка в измененных границах с кадастровым номером 86:04:0000001:6261	0,0263	
	86:04:0000001:6261:3У2		0,0011	
Одноцепная ВЛ-10кВ. БГПК-554км. L=15.4км. КТПН-3шт	86:04:0000001:25155:3У1	Образование земельного участка путем раздела с сохранением земельного участка в измененных границах с кадастровым номером 86:04:0000001:25155	0,0124	
Одноцепная ВЛ-6кВ. 564-672км. L=8км. КТПН- 2шт	86:04:0000001:98338:3У1	Образование земельного участка путем раздела с сохранением земельного участка в измененных границах с кадастровым номером 86:04:0000001:98338	0,0138	
Одноцепная ВЛ-6кВ.	86:04:0000001:112203:3У1	Образование земельного участка путем раздела с	2,0665	

564-672км. L=8км. КТПН- 2шт		сохранением земельного участка в измененных границах с кадастровым номером 86:04:0000001:112203			
Одноцепная ВЛ-6кВ. 564-672км. L=8км. КТПН- 2шт	86:04:0000001:112191:3У1	Образование земельного участка путем раздела с сохранением земельного участка в измененных границах с кадастровым номером 86:04:0000001:112191	0,0021	Земли промыш- ленности	
	86:04:0000001:112191:3У2		0,0069		
Одноцепная ВЛ-6кВ. 564-672км. L=8км. КТПН- 2шт	86:04:0000001:112250:3У1	Образование земельного участка путем раздела с сохранением земельного участка в измененных границах с кадастровым номером 86:04:0000001:112250	8,9239		
Одноцепная ВЛ-6кВ. 564-672км. L=8км. КТПН- 2шт	86:04:0000001:112251:3У1	Образование земельного участка путем раздела с сохранением земельного участка в измененных границах с кадастровым номером 86:04:0000001:112251	0,0084		
	86:04:0000001:112251:3У2		0,0196		
Одноцепная ВЛ-6кВ. 583-619. L=35,5км. КТПН-15шт.	86:04:0000001:25155:3У2	Образование земельного участка путем раздела с сохранением земельного участка в измененных границах с кадастровым номером 86:04:0000001:25155	0,0179		
Одноцепная ВЛ-6кВ. 583-619. L=35,5км. КТПН-15шт.	86:11:1001001:3У1	Образование земельного участка путем раздела с сохранением земельного участка в измененных границах с кадастровым номером 86:11:1001001	0,0309		Земли населен- ных пунктов
Одноцепная ВЛ-6кВ. 583-619. L=35,5км. КТПН-15шт.	86:11:1001001:3У2	Образование земельного участка путем раздела с сохранением земельного участка в измененных границах с кадастровым номером 86:11:1001001	0,2368		
	86:11:1001001:3У3		0,004		
Одноцепная ВЛ-6кВ. 583-619. L=35,5км. КТПН-15шт.	86:11:1001001:3058:3У1	Образование земельного участка путем раздела с сохранением земельного участка в измененных границах с кадастровым номером 86:11:1001001:3058	0,2384		
	86:11:1001001:3058:3У2		0,0109		
Одноцепная ВЛ-6кВ. 583-619. L=35,5км. КТПН-15шт.	86:11:1001001:2580:3У1	Образование земельного участка путем раздела с сохранением земельного участка в измененных границах с кадастровым номером 86:11:1001001:2580	0,0005		
	86:11:1001001:2580:3У2		0,0037		
Одноцепная ВЛ-6кВ. 583-619. L=35,5км. КТПН-15шт.	86:11:0902001:3У1	Образование земельного участка путем раздела с сохранением земельного участка в измененных границах с кадастровым номером 86:11:0902001	1,2803		
	86:11:0902001:3У2		0,0015		
Одноцепная ВЛ-6кВ.	86:11:0902001:531:3У1	Образование земельного участка путем раздела с	0,0095		

583-619. L=35,5км. КТПН-15шт.		сохранением земельного участка в измененных границах с кадастровым номером 86:11:0902001:531		
Одноцепная ВЛ-6кВ. 583-619. L=35,5км. КТПН-15шт.	86:11:0902001:322:3У1	Образование земельного участка путем раздела с сохранением земельного участка в измененных границах с кадастровым номером 86:11:0902001:322	0,0059	
Одноцепная ВЛ-6кВ. 583-619. L=35,5км. КТПН-15шт.	86:11:0902001:530:3У1	Образование земельного участка путем раздела с сохранением земельного участка в измененных границах с кадастровым номером 86:11:0902001:530	0,0131	Земли населенных пунктов
Одноцепная ВЛ-6кВ. 583-619. L=35,5км. КТПН-15шт.	86:11:0902001:326:3У1	Образование земельного участка путем раздела с сохранением земельного участка в измененных границах с кадастровым номером 86:11:0902001:326	0,0069	
Одноцепная ВЛ-6кВ. 583-619. L=35,5км. КТПН-15шт.	86:11:0902001:319:3У1	Образование земельного участка путем раздела с сохранением земельного участка в измененных границах с кадастровым номером 86:11:0902001:319	0,0073	
Одноцепная ВЛ-6кВ. 583-619. L=35,5км. КТПН-15шт.	86:11:0902001:3У3	Образование земельного участка путем раздела с сохранением земельного участка в измененных границах с кадастровым номером 86:11:0902001	8,2789	
	86:11:0902001:3У4		0,0472	
Одноцепная ВЛ-6кВ. 583-619. L=35,5км. КТПН-15шт.	86:11:0901001:3У1	Образование земельного участка путем раздела с сохранением земельного участка в измененных границах с кадастровым номером 86:11:0901001	0,5284	
Одноцепная ВЛ-6кВ. 583-619. L=35,5км. КТПН-15шт.	86:11:0901001:3У2	Образование земельного участка путем раздела с сохранением земельного участка в измененных границах с кадастровым номером 86:11:0901001	4,5422	
	86:11:0901001:3У3		0,0310	
Одноцепная ВЛ-6кВ. 583-619. L=35,5км. КТПН-15шт.	86:11:0903001:3У1	Образование земельного участка путем раздела с сохранением земельного участка в измененных границах с кадастровым номером 86:11:0903001	0,4487	
Одноцепная ВЛ-6кВ. 583-619. L=35,5км. КТПН-15шт.	86:11:0903001:3У2	Образование земельного участка путем раздела с сохранением земельного участка в измененных границах с кадастровым номером 86:11:0903001	3,4213	
	86:11:0903001:3У3		0,0334	
Одноцепная ВЛ-6кВ. 583-619. L=35,5км. КТПН-15шт.	86:11:0401001:3У1	Образование земельного участка путем раздела с сохранением земельного участка в измененных границах с кадастровым номером 86:11:0401001	0,7473	

Одноцепная ВЛ-6кВ. 583-619. L=35,5км. КТПН-	86:11:0903001:37:3У1	Образование земельного участка путем раздела с сохранением земельного участка в измененных границах с кадастровым номером 86:11:0903001:37	0,0073	
Одноцепная ВЛ-6кВ. 583-619. L=35,5км. КТПН-15шт.	86:11:0401001:3У2	Образование земельного участка путем раздела с сохранением земельного участка в измененных границах с кадастровым номером 86:11:0401001	3,7478	Земли населенных пунктов
	86:11:0401001:3У3		0,0634	
Одноцепная ВЛ-6кВ. 583-619. L=35,5км. КТПН-15шт.	86:11:0000000:69437:3У1	Образование земельного участка путем раздела с сохранением земельного участка в измененных границах с кадастровым номером 86:11:0000000:69437	0,0122	
Одноцепная ВЛ-6кВ. 583-619. L=35,5км. КТПН-15шт.	86:11:0000000:96:3У1	Образование земельного участка путем раздела с сохранением земельного участка в измененных границах с кадастровым номером 86:11:0000000:96	0,4970	
Одноцепная ВЛ-6кВ. 583-619. L=35,5км. КТПН-15шт.	86:11:0000000:69428:3У1	Образование земельного участка путем раздела с сохранением земельного участка в измененных границах с кадастровым номером 86:11:0000000:69428	0,3989	
Одноцепная ВЛ-6кВ. 583-619. L=35,5км. КТПН-15шт.	86:11:0000000:69432:3У1	Образование земельного участка путем раздела с сохранением земельного участка в измененных границах с кадастровым номером 86:11:0000000:69432	0,3311	
	86:11:0000000:69432:3У2		0,0036	
Одноцепная ВЛ-6кВ. 583-619. L=35,5км. КТПН-15шт.	86:11:0903001:36:3У1	Образование земельного участка путем раздела с сохранением земельного участка в измененных границах с кадастровым номером 86:11:0903001:36	0,0050	

Координаты поворотных точек границ земельного участка и зоны территории размещения проектируемого объекта определены в местной системе координат Ханты-Мансийского автономного округа – Югры МСК-86 (4-зона).

»;

2.2. Подраздел «Вид разрешенного использования образуемых земельных участков в соответствии с проектом планировки территории» изложить в следующей редакции:

«

**Вид разрешенного использования образуемых земельных участков ,
предназначенных для размещения линейных объектов и объектов
капитального строительства, проектируемых в составе линейного
объекта, а также существующих земельных участков, занятых
линейными объектами и объектами капитального строительства,
входящими в состав линейных объектов, в соответствии с проектом
планировки территории**

В соответствии с пунктом 13 части 1 статьи 25 Лесного кодекса Российской Федерации вид разрешенного использования образуемым земельным участкам устанавливается «строительство, реконструкция, эксплуатация линейных объектов».

Таблица 2

Наименование объекта	Номер земельного участка	Вид разрешенного использования земельного участка	Площадь земельного участка, га	Категория земель
Одноцепная ВЛ-10кВ. БГПК-554км. L=15.4км. КТПН-3шт	86:04:0000001:36247:3У1	строительство, реконструкция, эксплуатация линейных объектов	1,2682	Земли лесного фонда
	86:04:0000001:36247:3У11		0,2285	
Одноцепная ВЛ-10кВ. БГПК-554км. L=15.4км. КТПН-3шт	86:04:0000001:109986:3У1	строительство, реконструкция, эксплуатация линейных объектов	3,4749	Земли лесного фонда
	86:04:0000001:109986:3У2		0,0097	
Одноцепная ВЛ-10кВ. БГПК-554км. L=15.4км. КТПН-3шт	86:04:0000001:103576:3У1	строительство, реконструкция, эксплуатация линейных объектов	0,0251	
Одноцепная ВЛ-10кВ. БГПК-554км. L=15.4км. КТПН-3шт	86:04:0000001:32261:3У1	строительство, реконструкция, эксплуатация линейных объектов	12,9164	
	86:04:0000001:32261:3У2		0,0914	
Одноцепная ВЛ-10кВ. БГПК-554км. L=15.4км. КТПН-3шт	86:04:0000001:32259:3У1	строительство, реконструкция, эксплуатация линейных объектов	0,1503	
	86:04:0000001:32259:3У2		0,0033	
Одноцепная ВЛ-10кВ. БГПК-554км. L=15.4км. КТПН-3шт	86:04:0000001:22138:3У1	строительство, реконструкция, эксплуатация линейных объектов	0,0039	
	86:04:0000001:22138:3У2		0,001	
Одноцепная ВЛ-10кВ. БГПК-554км. L=15.4км. КТПН-3шт	86:04:0000001:109991:3У1	строительство, реконструкция, эксплуатация линейных объектов	1,0152	
Одноцепная ВЛ-10кВ. БГПК-554км. L=15.4км. КТПН-3шт	86:04:0000001:24347:3У1	строительство, реконструкция, эксплуатация линейных объектов	0,0062	
Одноцепная ВЛ-10кВ. БГПК-554км.	86:04:0000001:119410:3У1	строительство, реконструкция, эксплуатация линейных объектов	0.0192	

L=15.4км. КТПН-3шт				
Одноцепная ВЛ-6кВ. 583- 619. L=35,5км. КТПН-15шт.	86:04:0000001:36247:3У2	строительство, реконструкция, эксплуатация линейных объектов	6,1058	Земли лесного фонда
	86:04:0000001:36247:3У7		0,0026	
	86:04:0000001:36247:3У13		0,0062	
Одноцепная ВЛ-6кВ. 583- 619. L=35,5км. КТПН-15шт.	86:04:0000001:109999:3У1	строительство, реконструкция, эксплуатация линейных объектов	27,2107	
	86:04:0000001:109999:3У2		0,0850	
	86:04:0000001:109999:3У3		0,0012	
Одноцепная ВЛ-6кВ. 583- 619. L=35,5км. КТПН-15шт.	86:04:0000001:110005:3У1	строительство, реконструкция, эксплуатация линейных объектов	0,1506	
	86:04:0000001:110005:3У2		0,102	
Одноцепная ВЛ-6кВ. 583- 619. L=35,5км. КТПН-15шт	86:04:0000001:24392:3У1	строительство, реконструкция, эксплуатация линейных объектов	0,1119	
Одноцепная ВЛ-6кВ. 583- 619. L=35,5км. КТПН-15шт	86:04:0000001:117039:3У1	строительство, реконструкция, эксплуатация линейных объектов	0,0282	
Одноцепная ВЛ-6кВ. 583- 619. L=35,5км. КТПН-15шт	86:04:0000001:109990:3У1	строительство, реконструкция, эксплуатация линейных объектов	0,9061	
Одноцепная ВЛ-6кВ. 583- 619. L=35,5км. КТПН-15шт	86:04:0000001:109989:3У1	строительство, реконструкция, эксплуатация линейных объектов	0,2282	
Одноцепная ВЛ-6кВ. 583- 619. L=35,5км. КТПН-15шт	86:04:0000001:109667:3У1	строительство, реконструкция, эксплуатация линейных объектов	0,0128	
	86:04:0000001:109667:3У2		0,0054	
Одноцепная ВЛ-10кВ. БГПК-554км. L=15.4км. КТПН-3шт	86:04:0000001:36247:3У3	строительство, реконструкция, эксплуатация линейных объектов	0,2257	
	86:04:0000001:36247:3У12		1,1566	
Одноцепная ВЛ-10кВ. БГПК-554км. L=15.4км. КТПН-3шт	86:04:0000001:109984:3У1	строительство, реконструкция, эксплуатация линейных объектов	2,7250	
	86:04:0000001:109984:3У2		0,005	
	86:04:0000001:109984:3У3		18,1927	
	86:04:0000001:109984:3У4		0,0051	
Одноцепная ВЛ-10кВ. БГПК-554км. L=15.4км. КТПН-3шт	86:04:0000001:32239:3У1	строительство, реконструкция, эксплуатация линейных объектов	0,0273	
	86:04:0000001:32239:3У2		0,0009	
	86:04:0000001:32239:3У3		0,1714	
	86:04:0000001:32239:3У4		0,0057	
Одноцепная ВЛ-10кВ. БГПК-554км. L=15.4км. КТПН-3шт	86:04:0000001:109983:3У1	строительство, реконструкция, эксплуатация линейных объектов	0,0965	
	86:04:0000001:109983:3У2		0,0493	
Одноцепная ВЛ-10кВ. БГПК-554км. L=15.4км. КТПН-3шт	86:04:0000001:109670:3У1	строительство, реконструкция, эксплуатация линейных объектов	0,0231	
	86:04:0000001:109670:3У2		0,0097	
	86:04:0000001:109670:3У3		0,0634	
	86:04:0000001:109670:3У4		0,0458	
Одноцепная ВЛ-6кВ. 564- 672км. L=8км. КТПН-2шт	86:04:0000001:36247:3У4	строительство, реконструкция, эксплуатация линейных объектов	0,7506	Земли лесного фонда

Одноцепная ВЛ-6кВ. 564- 672км. L=8км. КТПН-2шт	86:04:0000001:109988:3У1	строительство, реконструкция, эксплуатация линейных объектов	4,5167	
Одноцепная ВЛ-6кВ. 564- 672км. L=8км. КТПН-2шт	86:04:0000001:109672:3У1	строительство, реконструкция, эксплуатация линейных объектов	0,0076	
	86:04:0000001:109672:3У2		0,0071	
Одноцепная ВЛ-6кВ. 583- 619. L=35,5км. КТПН-15шт.	86:04:0000001:36247:3У5	строительство, реконструкция, эксплуатация линейных объектов	2,8246	
	86:04:0000001:36247:3У8		1,0008	
	86:04:0000001:36247:3У9		0,0020	
Одноцепная ВЛ-6кВ. 583- 619. L=35,5км. КТПН-15шт.	86:04:0000001:109985:3У1	строительство, реконструкция, эксплуатация линейных объектов	16,7413	
	86:04:0000001:109985:3У2		0,0358	
	86:04:0000001:109985:3У3		0,0140	
Одноцепная ВЛ-6кВ. 583- 619. L=35,5км. КТПН-15шт.	86:04:0000001:109671:3У1	строительство, реконструкция, эксплуатация линейных объектов	0,0887	
	86:04:0000001:109671:3У2		0,0516	
Одноцепная ВЛ-6кВ. 583- 619. L=35,5км. КТПН-15шт.	86:04:0000001:3976:3У1	строительство, реконструкция, эксплуатация линейных объектов	0,0260	
Одноцепная ВЛ-6кВ. 583- 619. L=35,5км. КТПН-15шт.	86:04:0000001:4279:3У1	строительство, реконструкция, эксплуатация линейных объектов	0,0155	
Одноцепная ВЛ-6кВ. 583- 619. L=35,5км. КТПН-15шт.	86:04:0000001:4278:3У1	строительство, реконструкция, эксплуатация линейных объектов	0,0077	
Одноцепная ВЛ-6кВ. 583- 619. L=35,5км. КТПН-15шт.	86:04:0000001:109992:3У1	строительство, реконструкция, эксплуатация линейных объектов	1,5113	
Одноцепная ВЛ-6кВ. 583- 619. L=35,5км. КТПН-15шт.	86:04:0000001:8099:3У1	строительство, реконструкция, эксплуатация линейных объектов	0,0242	
Одноцепная ВЛ-6кВ. 583- 619. L=35,5км. КТПН-15шт.	86:04:0000001:25859:3У1	строительство, реконструкция, эксплуатация линейных объектов	0,0331	Земли лесного фонда
Одноцепная ВЛ-6кВ. 583- 619. L=35,5км. КТПН-15шт.	86:04:0000001:15232:3У1	строительство, реконструкция, эксплуатация линейных объектов	0,0023	
Одноцепная ВЛ-6кВ. 583- 619. L=35,5км. КТПН-15шт.	86:04:0000001:110002:3У1	строительство, реконструкция, эксплуатация линейных объектов	9,4319	
	86:04:0000001:110002:3У2		0,0252	
Одноцепная ВЛ-6кВ. 583- 619. L=35,5км. КТПН-15шт.	86:04:0000001:110003:3У1	строительство, реконструкция, эксплуатация линейных объектов	1,1584	
	86:04:0000001:110003:3У2		0,0001	
Одноцепная ВЛ-6кВ. 583- 619. L=35,5км. КТПН-15шт.	86:04:0000001:110006:3У1	строительство, реконструкция, эксплуатация линейных объектов	0,0490	
	86:04:0000001:110006:3У2		0,0445	

Одноцепная ВЛ-6кВ. 583- 619. L=35,5км. КТПН-15шт.	86:04:0000001:26579:3У1	строительство, реконструкция, эксплуатация линейных объектов	0,0041		
Одноцепная ВЛ-6кВ. 583- 619. L=35,5км. КТПН-15шт.	86:04:0000001:26545:3У1	строительство, реконструкция, эксплуатация линейных объектов	0,0045		
Одноцепная ВЛ-6кВ. 583-619. L=35,5км. КТПН-15шт.	86:04:0000001:113595:3У1	строительство, реконструкция, эксплуатация линейных объектов	0,0012		
	86:04:0000001:113595:3У2		0,8952		
Одноцепная ВЛ-6кВ. 583-619. L=35,5км. КТПН-15шт.	86:04:0000001:113568:3У1	строительство, реконструкция, эксплуатация линейных объектов	0,0046		
Одноцепная ВЛ-6кВ. 583-619. L=35,5км. КТПН-15шт.	86:04:0000001:114646:3У1	строительство, реконструкция, эксплуатация линейных объектов	0,0022		
	86:04:0000001:114646:3У2		0,0715		
Одноцепная ВЛ-6кВ. 583-619. L=35,5км. КТПН-15шт.	86:04:0000001:114512:3У1	строительство, реконструкция, эксплуатация линейных объектов	0,0023	Земли лесного фонда	
	86:04:0000001:114512:3У2		0,0534		
Одноцепная ВЛ-6кВ. 583-619. L=35,5км. КТПН-15шт.	86:04:0000001:113593:3У1	строительство, реконструкция, эксплуатация линейных объектов	0,0062		
	86:04:0000001:36247:3У6		строительство, реконструкция, эксплуатация линейных объектов	0,3745	
	86:04:0000001:36247:3У10		0,0005		
Одноцепная ВЛ-6кВ. 564- 672км. L=8км. КТПН-2шт	86:04:0000001:36247:3У14		0,3165		
	86:04:0000001:109982:3У1	строительство, реконструкция, эксплуатация линейных объектов	2,6906		
86:04:0000001:109982:3У2	0,0016				
Одноцепная ВЛ-6кВ. 564- 672км. L=8км. КТПН-2шт	86:04:0000001:109669:3У1	строительство, реконструкция, эксплуатация линейных объектов	0,0032		
	86:04:0000001:109669:3У2		0,0081		
Одноцепная ВЛ-6кВ. 564- 672км. L=8км. КТПН-2шт	86:04:0000001:109668:3У1	строительство, реконструкция, эксплуатация линейных объектов	0,0065		
	86:04:0000001:109668:3У2		0,0152		
Одноцепная ВЛ-6кВ. 564- 672км. L=8км. КТПН-2шт	86:04:0000001:109987:3У1	строительство, реконструкция, эксплуатация линейных объектов	3,3143		
	86:04:0000001:109987:3У2		0,0015		
Одноцепная ВЛ-6кВ. 564- 672км. L=8км. КТПН-2шт	86:04:0000001:109981:3У1	строительство, реконструкция, эксплуатация линейных объектов	0,0450		
Одноцепная ВЛ-10кВ. БГПК-554км. L=15.4км. КТПН-3шт	86:04:0000001:3У9	Энергетика	0,4064	Земли запаса	
	86:04:0000001:3У12		0,0102		

Одноцепная ВЛ-6кВ. 564-672км. L=8км. КТПН- 2шт	86:04:0000001:3У10		1,7684	
Одноцепная ВЛ-6кВ. 583- 619. L=35,5км. КТПН-15шт.	86:04:0000001:3У11		0,2999	
	86:04:0000001:3У13		0,0038	
Одноцепная ВЛ-10кВ. БГПК-554км. L=15.4км. КТПН-3шт	86:04:0000001:98340:3У1	Энергетика	0,0053	Земли промышлен ности
	86:04:0000001:98340:3У2		0,0004	
Одноцепная ВЛ-10кВ. БГПК-554км. L=15.4км. КТПН-3шт	86:04:0000001:6261:3У1	Энергетика	0,0263	
	86:04:0000001:6261:3У2		0,0011	
Одноцепная ВЛ-10кВ. БГПК-554км. L=15.4км. КТПН-3шт	86:04:0000001:25155:3У1	Энергетика	0,0124	
Одноцепная ВЛ-6кВ. 564- 672км. L=8км. КТПН-2шт	86:04:0000001:98338:3У1	Энергетика	0,0138	
Одноцепная ВЛ-6кВ. 564- 672км. L=8км. КТПН-2шт	86:04:0000001:112203:3У1	Энергетика	2,0665	
Одноцепная ВЛ-6кВ. 564- 672км. L=8км. КТПН-2шт	86:04:0000001:112191:3У1	Энергетика	0,0021	
	86:04:0000001:112191:3У2		0,0069	
Одноцепная ВЛ-6кВ. 564- 672км. L=8км. КТПН-2шт	86:04:0000001:112250:3У1	Энергетика	8,9239	
Одноцепная ВЛ-6кВ. 564- 672км. L=8км. КТПН-2шт	86:04:0000001:112251:3У1	Энергетика	0,0084	
	86:04:0000001:112251:3У2		0,0196	
Одноцепная ВЛ-6кВ. 583- 619. L=35,5км. КТПН-15шт.	86:04:0000001:25155:3У2	Энергетика	0,0179	
Одноцепная ВЛ-6кВ. 583- 619. L=35,5км. КТПН-15шт.	86:11:1001001:3У1	Энергетика	0,0309	Земли населенн ых пунктов
Одноцепная ВЛ-6кВ. 583- 619. L=35,5км. КТПН-15шт.	86:11:1001001: 3У2	Энергетика	0,2368	
	86:11:1001001:3У3		0,004	
Одноцепная ВЛ-6кВ. 583- 619. L=35,5км. КТПН-15шт.	86:11:1001001:3058:3У1	Энергетика	0,2384	
	86:11:1001001:3058:3У2		0,0109	
Одноцепная ВЛ-6кВ. 583- 619. L=35,5км.	86:11:1001001:2580:3У1	Энергетика	0,0005	

КТПН-15шт.	86:11:1001001:2580:3У2		0,0037	Земли населенных пунктов
Одноцепная ВЛ-6кВ. 583-619. L=35,5км. КТПН-15шт.	86:11:0902001:3У1	Энергетика	1,2803	
	86:11:0902001:3У2		0,0015	
Одноцепная ВЛ-6кВ. 583-619. L=35,5км. КТПН-15шт.	86:11:0902001:531:3У1	Энергетика	0,0095	
Одноцепная ВЛ-6кВ. 583-619. L=35,5км. КТПН-15шт.	86:11:0902001:322:3У1	Энергетика	0,0059	
Одноцепная ВЛ-6кВ. 583-619. L=35,5км. КТПН-15шт.	86:11:0902001:530:3У1	Энергетика	0,0131	
Одноцепная ВЛ-6кВ. 583-619. L=35,5км. КТПН-15шт.	86:11:0902001:326:3У1	Энергетика	0,0069	
Одноцепная ВЛ-6кВ. 583-619. L=35,5км. КТПН-15шт.	86:11:0902001:319:3У1	Энергетика	0,0073	
	86:11:0902001:3У3		8.2789	
Одноцепная ВЛ-6кВ. 583-619. L=35,5км. КТПН-15шт.	86:11:0902001:3У4	Энергетика	0.0472	
	86:11:0901001:3У1		0,5284	
Одноцепная ВЛ-6кВ. 583-619. L=35,5км. КТПН-15шт.	86:11:0901001:3У2	Энергетика	4,5422	
	86:11:0901001:3У3		0,0310	
Одноцепная ВЛ-6кВ. 583-619. L=35,5км. КТПН-15шт.	86:11:0903001:3У1	Энергетика	0,4487	
Одноцепная ВЛ-6кВ. 583-619. L=35,5км. КТПН-15шт.	86:11:0903001:3У2	Энергетика	3,4213	
	86:11:0903001:3У3		0,0334	
Одноцепная ВЛ-6кВ. 583-619. L=35,5км. КТПН-15шт.	86:11:0401001:3У1	Энергетика	0,7473	
Одноцепная ВЛ-6кВ. 583-619. L=35,5км. КТПН-15шт.	86:11:0903001:37:3У1	Энергетика	0,0073	
Одноцепная ВЛ-6кВ. 583-619. L=35,5км. КТПН-15шт.	86:11:0401001:3У2	Энергетика	3,7478	Земли населенных пунктов
	86:11:0401001:3У3		0,0634	
Одноцепная ВЛ-6кВ. 583-619. L=35,5км. КТПН-15шт.	86:11:0000000:69437:3У1	Энергетика	0,0122	

Одноцепная ВЛ-6кВ. 583- 619. L=35,5км. КТПН-15шт.	86:11:0000000:96:3У1	Энергетика	0,4970
Одноцепная ВЛ-6кВ. 583- 619. L=35,5км. КТПН-15шт.	86:11:0000000:69428:3У1	Энергетика	0,3989
Одноцепная ВЛ-6кВ. 583- 619. L=35,5км. КТПН-15шт.	86:11:0000000:69432:3У1	Энергетика	0,3311
	86:11:0000000:69432:3У2		0,0036
Одноцепная ВЛ-6кВ. 583- 619. L=35,5км. КТПН-15шт.	86:11:0903001:36:3У1	Энергетика	0,0050

».

Директор Департамента
пространственного развития
и архитектуры автономного
округа – главный архитектор

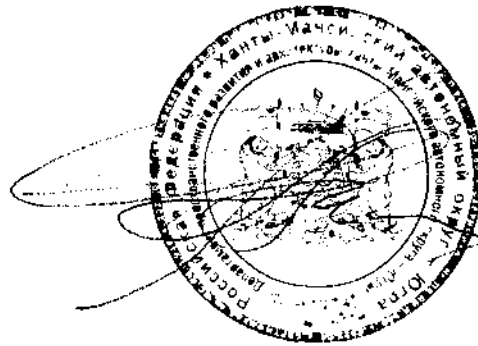

В.В.Семенова